

Uncovering the Missing Secrets of Magnetism

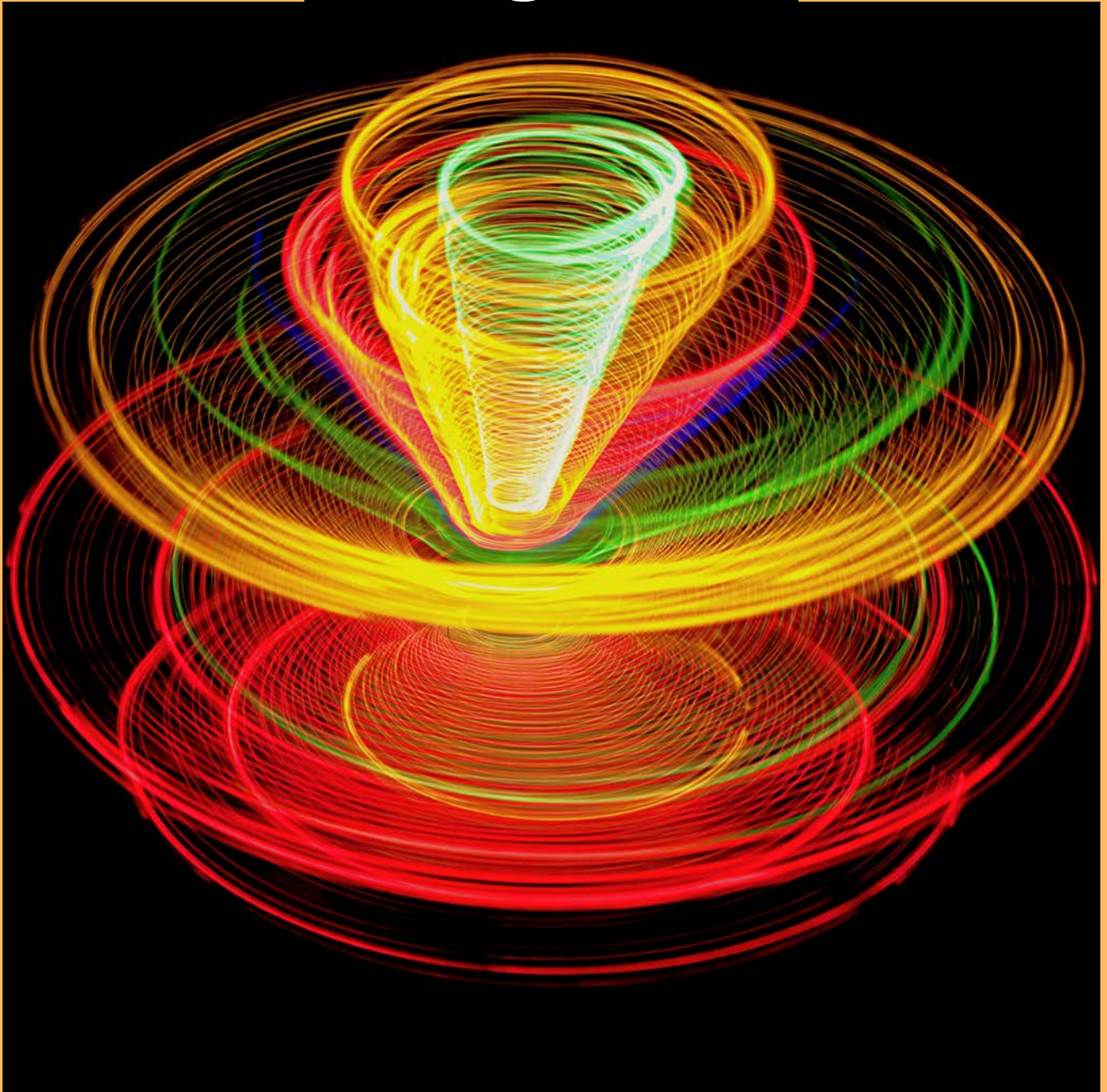

Exploring the nature of Magnetism, with regards to the true model of atomic geometry and field mechanics by means of rational physics & logic

Ken L. Wheeler

Uncovering the Missing Secrets of Magnetism

Exploring the nature of Magnetism, with regards to the true model of atomic geometry and field mechanics by means of rational physics & logic

by: Ken Lee Wheeler

3rd Edition September 25 2014

All Rights Reserved. Copyright © 6-15-2014

DARKSTAR PUBLICATIONS

No part of this book may be reproduced or transmitted in any form or by any means, graphic, electronic, or mechanical, including photocopying, recording, taping or by any information storage or retrieval system, without the permission in writing from Darkstar Publications.

neoplatonist@icloud.com

Published by Darkstar Publications



This book is dedicated to the late *D. Anderson*, without out her support and convictions, this work would not have been possible. Likewise, consideration goes out to *T. Martin*, & especially *T. Vanderelli of ferrocell.us*

LUX ET VERITAS

ISBN 0-9712541-8-4

\$10.00 U.S.

Printed in the United States of America



CONTENTS

What you assume was known and understood about magnetism, is not, ...until now

A very brief historical glimpse of earliest magnetic comprehension

Electron nonsense, dismissing the 'discharge particle' fallacy

The 'electron microscope' lie

Where is your magnet's polarity, and which side is which? The easy way

Ferrofluid

This is not the model of magnetism. The iron filings grand error

Magnetic Fields. Rational descriptions vs. irrational reifications

Tesla against Einstein and for the Ether

Counterspace, the Ether

Magnetic precession rates of the gyromagnetic-ratio at 42.4923 Mhz/T in creating the magnetic vortex

Magnetic pressure gradients along the golden ratio at 137.5077 degrees common to phyllotaxis

What is a magnet & magnetism, really?

James Clerk Maxwell's "idle wheel" analogy

The 'magnet' isn't a magnet, it's an electrified dielectric object

Magnets, naturally, are spatially self-folding, but not due to magnetism

Electrical current, or permanent magnet?

Magnetic Geometry, or the Bell-disk mutual-repulsion model of magneto-dielectricity

Magnetism continued

The laser analogy

Magnetism continued II

Magnetic attraction absolutely does not exist whatsoever. Forwarding the seemingly impossible but hyper-logical fact, which is evidenced by all observed phenomena, and understanding of the fundamental forces.

Diamagnetic bismuth's missing secret, and magnetic 'levitation' perfected using a 'programmed' bismuth discovery.

Two examples of dielectric inertia

All heavy element roads terminate into lead, but only Neptunium ends in bismuth

Spatial cubes and counterspatial dielectric-inertia bismuth 'anti-cubes'. Space & Counterspace part II

The magneto-dielectric hyperboloid, or defining field inertia vs. magnetism / space / movement

The Euclidean Ether expressed in four modalities and one principle of inertia

The RGB LED discovery of the dielectric voidance of light at the dielectric inertial plane of the 'magnet'

Magnetism vs. Dielectricity, redefining the long-held nonsense of "magnetic attraction & magnetic repulsion", or 'the middle'

An analogy, both of the "magnet" and human ignorance

Divergence and Convergence as a model of dielectric discharge, magnetism, and centripetal convergence

Proof magnetic centrifugal and centripetal reciprocations follow the golden ratio and are a system hyperboloid of Phi cubed

CRT Tube dynamics of dielectric influence from magnetic deflection and dielectric voidance

The Ferrocil demonstrations of magnetic hyperboloids and magneto-dielectric divergence and convergence

The missing secrets of XYZ-axis spatial-counterspatial geometry of dielectricity, magnetism, electricity, and gravity

Gravity

Smashing incoherent magneto-dielectric spheres into gyroscopic E.M.F. and M.M.F. disks

The dielectric inertial plane, or "Bloch wall". Correcting the magnetic 'domain wall' fallacy

Dielectric torque in the creation of electrification from magnetism

The correct architecture of the atom. The double conjugated pair model of the atom

Atomic orbitals geometry as logically explained by magneto-dielectric inter-atomic volume

Galactic jets as magnetic and electrified magneto-dielectric models

Light's missing secret, or, electromagnetism is not purely (or mostly) electromagnetic at all

The Photoelectric effect lie corrected, the dielectric discharge effect

Refraction and dispersion of light thru a medium

Kha and other words denoting 'zero', the metaphysics of counterspace, and the ancient wheel analogy of space & counterspace

Experimenters are blooming with thoughts and wonderful new vortex testing based upon this work. Vortex technology is the future, and it is already here and about to explode on the world!

4TH EDITION DUE OUT VERY SOON! THERE IS AN ENORMOUS AMOUNT OF MATERIAL TO ADD, WITH INCREASING COMPLEXITY AND DETAIL.



CREDITS & CONSIDERATIONS:

My deepest and warm thanks go out to **Timm Vanderelli of Ferrocell U.S.A.** in material support & providing more empirical proof for the worlds first accurate explanation of how a magnet works, as illuminated in this work. Magneto-dielectric field incommensurability (F.I.) can now not only be defined in full but also illustrated in depth by use of the **T. Vanderelli Ferrocell invention (US8246356, US20070241745)**. All my accurate conclusions of magneto-dielectric conjugate field incommensurability now have further empirical validity thanks to the ferrocell; after the fact of my discovery, and my disclosure of the magneto-dielectric field mechanics as to how a 'magnet' operates, its field inertia and discharge hyperboloid formation, I learned of the ferrocell invention. After the 2nd edition, I came across the ferrocell, one of the key empirical validities I needed to prove my theory accurate.

*Every institute of learning, even down to high school and lower, **should own a ferrocell** to educate, inspire, and enlighten future minds as to the fundamental forces of nature hidden within light and especially magnetism; which are governed by dielectric inertia both in whole and in part. The old method of demonstrating magnetism via iron filings is both horrible and an error since the iron dust undergoes magnetic induction. **The only true and accurate way to see dielectricity & magnetism is with light, and the ferrocell!***

I highly suggest visiting his page and web portal for the purchase of the Ferrocell and his newest invention, the E.D.U. <http://ferrocell.us/products.html>

From Timm Vanderelli:

The Ferrocell is a simple, low-cost device that will scatter light in a direction determined by the application of a magnetic field (magnetic anisotropy). Polarized *or* un-polarized light will reveal a representation of the applied field with a 3-D spatial geometry in agreement with Maxwell's Equations. Utilizing quantum effects made possible by nanotechnology, this Ferrohydrodynamic Lens has the potential to enhance the performance of many existing Photonic applications.

Apply light and magnetism to either surface. The strength and orientation of the applied field will determine the plane (angle) of light coming out of the cell. Using a permanent magnet is the simplest way to apply a field and see how a Ferrocell will change the path of light. To make this event visible to the naked eye, a large surface area and strong magnetic fields are required. Currently, there are no demonstration units available for smaller scales. Although similar to the Faraday Effect, a Ferrocell affects light up to 90 degrees in a single stage, whereas a Faraday rotator would require two stages to accomplish the same task.. And a Ferrocell will exhibit the same results with polarized or non-polarized light. Using four stages of deflection with a Ferrocell will allow 360 degrees of rotation.



Photos courtesy of Timm Vanderelli

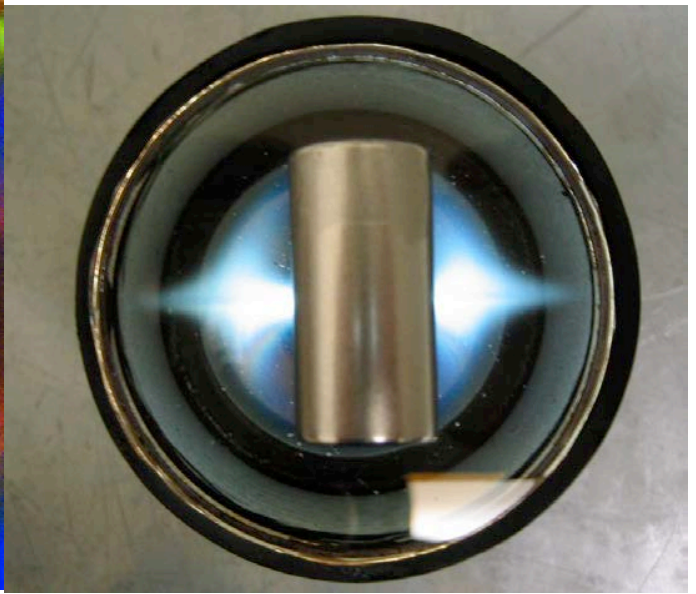
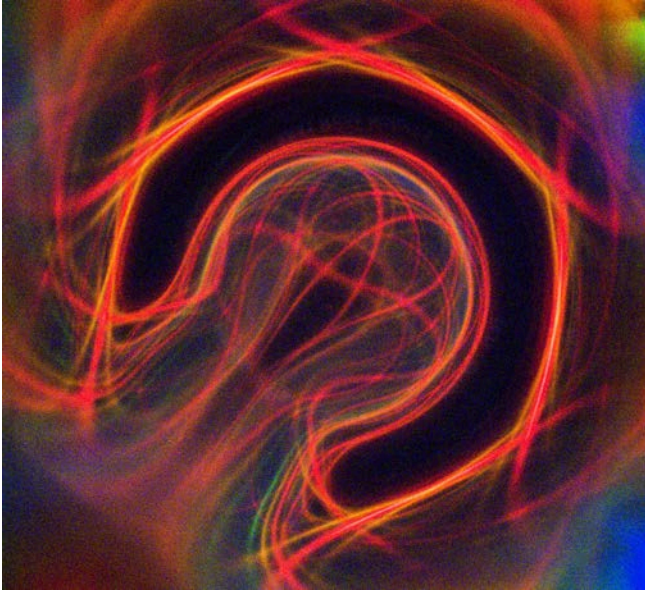

“Directing Light with Electromagnetism” FERROCELL.US



Many superior magnets used in the making of this work purchased from: www.kjmagnetics.com



Some images in this work were created using the ingenious and mentally stimulating **Überdoodle application!**

The creators of the app are: *Morten Bek Ditlevsen and Johanne Bek Ditlevsen*

The Überdoodle application for Ipad and Iphone can be obtained at:

<https://itunes.apple.com/us/app/uberdoodle/id372062013?mt=8>

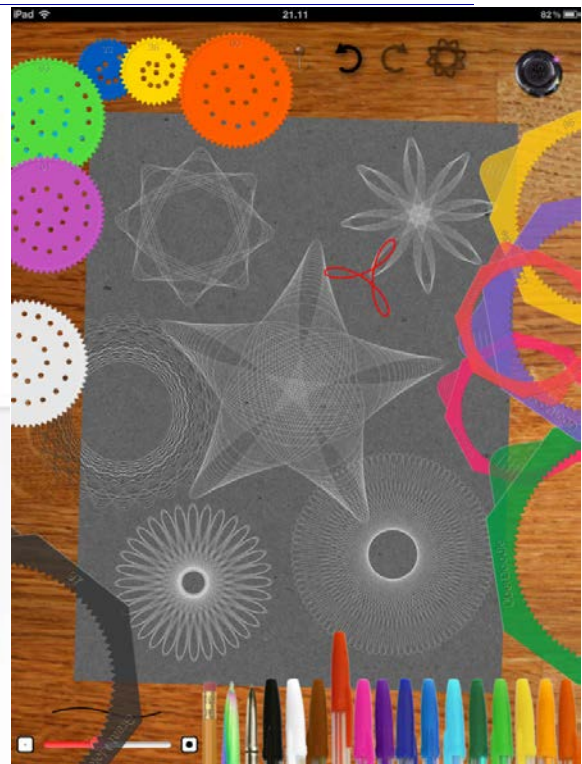

*Little did the creators of the Spirograph or the software designers of Überdoodle realize that this geometric hyperboloid is the exact divergent and convergent pattern created by magnetic field reciprocation! What does the **loss of dielectric inertia** create in centrifugal spatial vectorization (i.e. magnetism)? Why, a hypotrochoid roulette ('spirograph'-like pattern) polarization and the creation of a spatial hyperboloid, of course! These images below from the T. Vanderelli ferrocell however are not drawings, but genuine magnetic field reciprocations as imaged by the radial dielectric torque of light in response to magnetic divergences and convergences. The "dielectric field"- Faraday, necessitated this formation. Now lets explain why....*

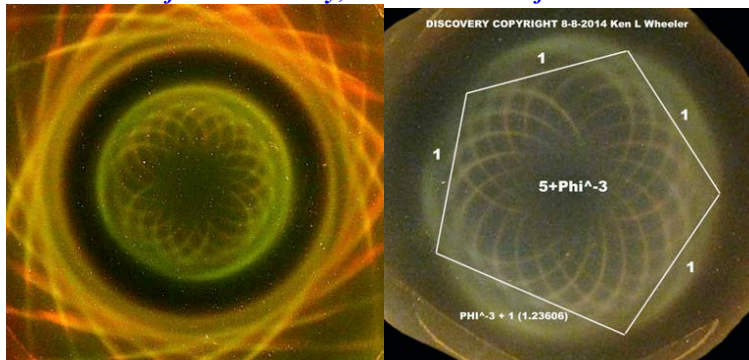

The magnetic 'happy face' coincidence. Photo by Michael Snyder of www.revolution-labs.com

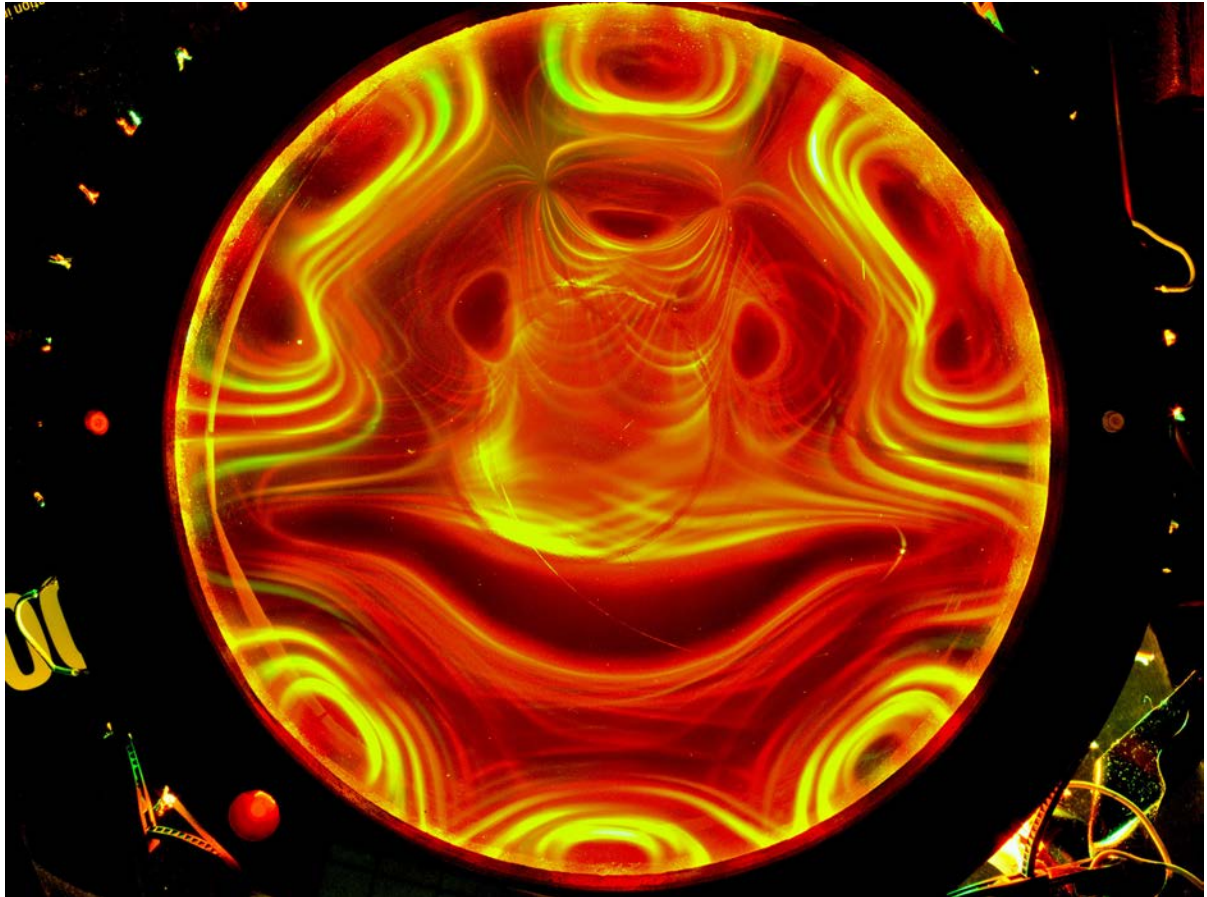

Many photographic credits in this work and thanks go out to *Michael Snyder*
[Check out Michael Snyder's information at:](http://www.facebook.com/ferrofluidcells)
www.facebook.com/ferrofluidcells and www.revolution-labs.com

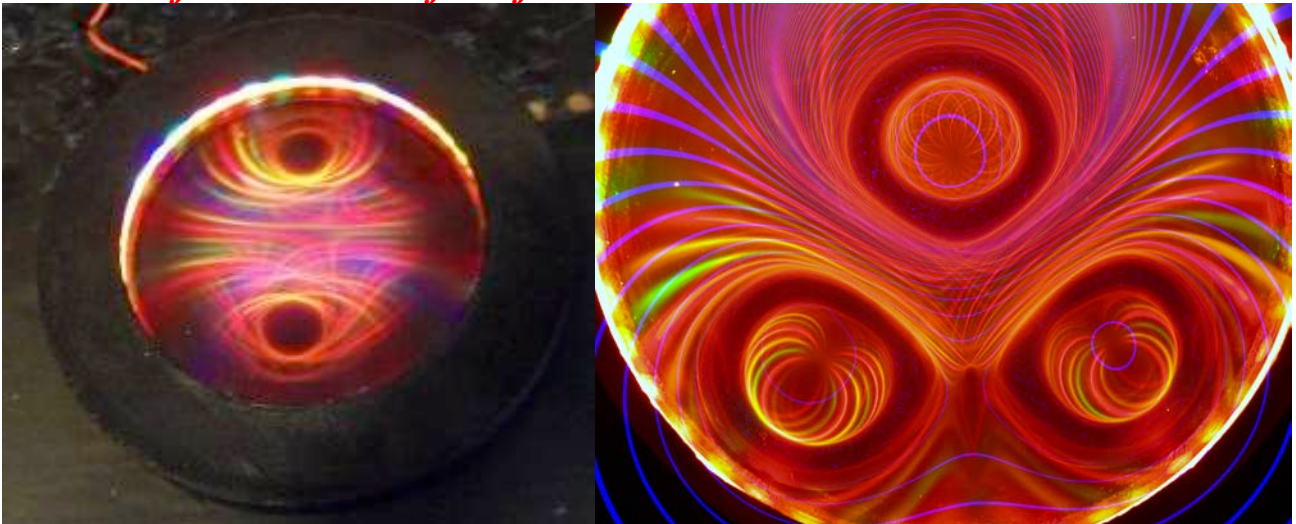

What you assume was known and understood about magnetism, is not, ...until now

Nikola Tesla November 1928 interview:

Toward the end of the interview, we asked Tesla which arena of science most appealed to him. While we expected him to mention radios and airplanes, the world wireless system, it was not the induction motor; instead it was the discovery of the principle that preceded the induction motor, the "rotating magnetic field". **Tesla answered: "rotating magnetic fields were dear to my heart. When I made the discovery of the rotating magnetic field, I was a very young man. The revelation came after years of concentrated thought and it was my first great thrill. It was not only a valuable discovery capable of extensive practical applications. It was a REVELATION OF NEW FORCES AND NEW PHENOMENA unknown to science before".**

"No", Dr. Tesla said with some feelings, "I would not give my rotating magnetic field discovery for a thousand inventions, however valuable, designed merely as mechanical contraptions to deceive the eye and ear!"

Then saying: "A thousand years hence, the telephone and the motion picture camera may be obsolete, but the principle of the rotating magnetic field will remain a vital, living thing for all time to come." - Nikola Tesla

Article: "A Famous Prophet of Science Looks into the Future" (Popular Science Monthly)

Of all the types of people who have ever lived, there are only four types of gatekeepers of the mind. 1. The gatekeeper of the mind which lets in everything, this is the most common type in the world. 2. The gatekeeper of the mind which lets in nothing, this is the second most common type; of those that are sure they are right, and all others are wrong. 3. The gatekeeper of the mind which lets in those things it likes or agrees with and not those things it does not like or agree with, even if those things are true and wise. This is the third most common type. 4. The gatekeeper of the mind which judges things as wise and logical, and lets those things in, and judges things as unwise and irrational and bars them from entry into the mind. This type of gatekeeper of the mind is the most sublime and rare. Open minds are only good up to a point at which nonsense, lies, and irrational chaos is allowed to enter. Closed minds are only good up to a point where things wise and true are barred entry. At this point we must agree that wholly open minds are bad, and wholly closed minds are equally as bad. – Author

"If you were to tell someone close to you that **'there is utterly no such thing as magnetic attraction'**, they would inquire as to your medication or wonder what the punch line is. The very premise, from countless thousands of years past to the present, as evidenced from 'magnets' accelerating nails, iron bits, and ferrous objects to the 'magnet', and 'opposite poles attracting/accelerating towards each other', is as deeply ingrained in the human consciousness as the Sun rising in the East every morning. The ancient lie, this perceptual titanic error is as innate as breathing. As is the case, all attraction (and 'repulsion') is governed by dielectricity, not magnetism, which is the **'dielectric field' -Faraday**, which in discharging, is the radiation Ether-modality we call magnetism. That magnetism is reaching out in space is not in question, however radiation only displaces things, as in the case of magnetism, causes an inductive reaction at the interatomic magneto-dielectric of ferrous objects, thereby causing dielectric coherency from magnetic displacement and resultant acceleration to the 'magnet' as the act of dielectric voidance. Radiation attracts nothing. Soon you will find out the simplex nature of the "magnet" which is powered by dielectric coherency (either I.D.C. induced dielectric coherency, or I.D.C.C. induced dielectric capacitance and coherency) and likewise you will have a clear, lucid, logical, coherent, proved understanding of magnets and magnetism that explains all observed phenomena of same" - Author

That the term 'magnet' comes from, in earliest times, the word for 'magic' can tell you 5000 years of the fascination of humanity into, not magnets specifically, but their fields and action at a distance - Author

For the first time, the nature of magnetism in full detail, shall be set straight, logically, lucid, coherent, consistent, provable, and explain all phenomena of what humans do not grasp of and about the "magnet" and magnetism.

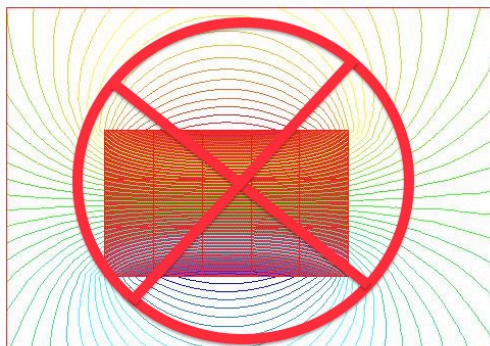
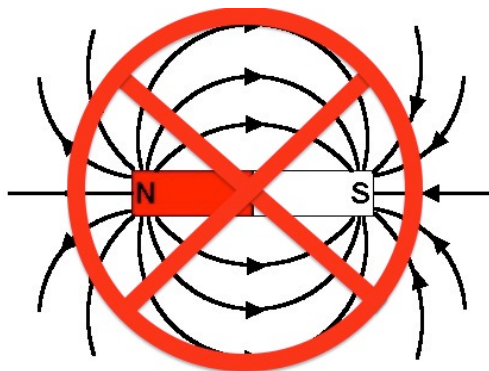

And this shows the magnetic field around a group of domains that are all lined up together.

"Scientists today think deeply rather than clearly. One must be sane to think clearly, but one can think deeply and be quite insane. Today's scientists have substituted mathematics for experiments, and they wander thru equation after equation, and eventually build a structure which has no basis in reality." – Nikola Tesla

“You can always recognize a relativist, they will either ask you for your credentials, or offer their credentials without you asking for or about them.”

“Nothing is more fantastical and a travesty of how nature works than is quantum theory. Its very basis has no relationship to reality.”
– **W. Russell**

“Where common sense and intuition failed, we (the insane relativists) had to create a new form of intuition based upon abstract (unreal) mathematics. When common sense fails, we must create uncommon sense.” – **Leonard Susskind, professor theoretical physics, and priest of the cult of Quantum**

Quantum insanity: “Everything we call real is made up of things that cannot be real.” – **N. Bohr**

Quantum insanity: “The more you see how strange nature behaves, the harder it is for us to make a model that explains even the how the most simple phenomena works. Theoretical physics has given up on this pursuit.” – **R. Feynman**

Below: Let us, in the following chapters, learn what magnetism really is in explanation, not descriptions, not the long-held lies, speculations, and nonsense propagated for far too long.

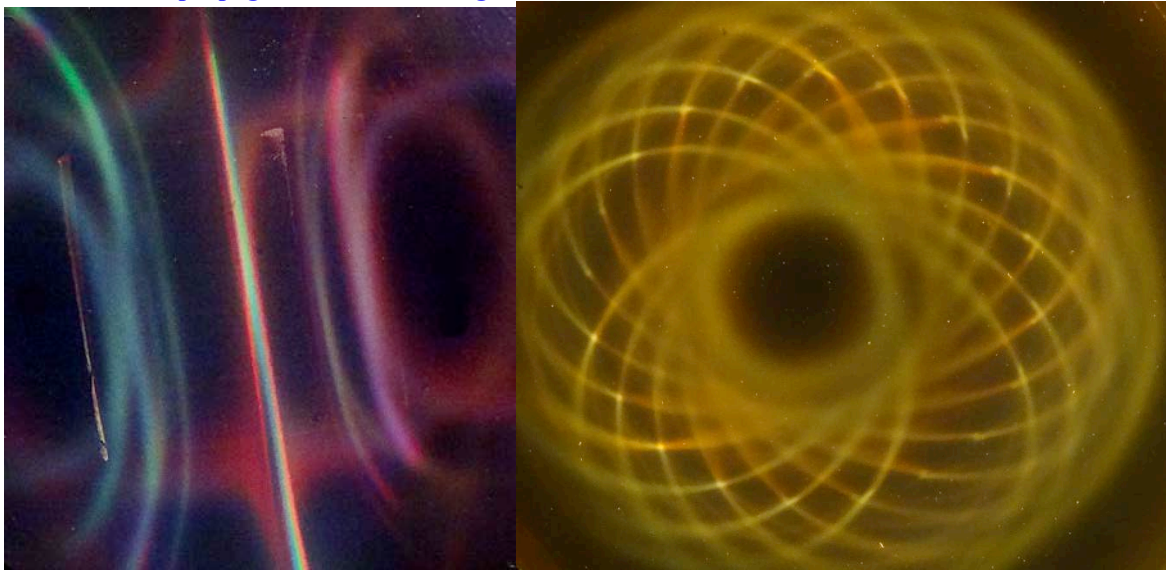

This article is meant to be a deep but clear primer to reverse the mass of ignorance and set the reader down the correct road regarding magnetism and paint a clear, logical, lucid, and rational picture as to the nature of magnetism. **Its editions will expand over time.**

While this work will expand over time, I must state that if you cannot explain it simply then you do not really understand something. There are many great non-fiction books on many subjects, however all of them could be removed of superfluous nonsense and reduced by at least 80%, such was the premise for this article; time in life in short, and reading ten pages to find one morsel of truth and helpful insight, I have always found infuriating. Nothing is more hubristic than taking 100 pages to say something that can easily be said in 10. I state outright that for the very first time in history, I will lucidly, rationally, logically, with reason and evidence present you with the genuine model of magnetism, what it is, then what it really is (rather is not in principle but in attribute), how it moves, how it operates, with geometry, angles, charge, and unique specificity with parallel clarity.

Additionally regarding magnetism, I will supply you with numerous diagrams showing orientation, movements, pressures, specific angles, and countless first-time revelations about magnetism that will paint a lucid coherent picture, like a laser, burning thru accretions of ignorance about magnetism, to what magnetism really is, its relationship to the other 3 forces, what induces what, what terminates into what and as what. Lastly, and uniquely, I will present you with the correct nature of light, never before fully understood, formerly only half-grasped, and finally a chart showing force unification of gravity, magnetism, dielectricity, and electricity that is so simple, so logical, so undeniable, that even a 15 year old can grasp it; within which is included the equation (G.U.T.) behind all force unification.

In writing this very condensed article on magnetism after downloading and owning every book ever written on magnetism, every video ever made on magnetism, and growing up to know this whole time that something is completely askew about magnetism, namely instantaneous action at a distance, how magnetism operates in a total vacuum and thru things upon other ferrous objects, I made an “all or nothing” desire to understand magnetism, how it works, what it works, what it really is. Rational physics (in one sense) was the only logical approach to understanding magnetism, the “virtual photons” explanation of quantum mysticism is no more rational than evoking angels or saying Atlas is holding up the world from below. These demons of mental midgetry have invaded science like a plague; GR and QM have, as Tesla stated, made a mockery of genuine science and clear thinking.

I have attempted to keep this article extremely lucid however I placed no work into doing same, since it naturally fell that way without any assistance from my own, which of course is always an extremely good sign, anytime something has to be twisted to make it lucid. it likely wasn't logical or correct to begin with. I must confess to a secret in the creation of this article. apart from owning

every book, article and video ever made on magnetism, nearly 100% of which are utterly nonsensical and self-contradictory trash, I used an ancient methodology with which I made myself intrinsically familiar with well over a decade ago, the same method used by Pythagoras, Plato, Plotinus and others; a missing lost rarified art which made Plato's and Socrates works so extremely logical, lucid and self consistent. That method is retroduction, not deduction or induction, but the ancient lost art of retroduction. Using all my experiments and many more into magnetism, I placed all this knowledge thru the Platonic prism of retroduction to draw forth the missing secrets of magnetism, and instead of getting a gush of knowledge, I got a rapidly unfolding dam break as it were of insights into things both deep and so obvious that it erased a lifetime of bad programming and information I was fed (along with everyone else) on magnetism. Literally "working backwards", retroduction is a lost ancient method of discovery so acutely helpful its amazing this art is lost completely to modernity, especially that it is so quick in its workings. While deduction and induction sift thru the hay stack for the needle, retroduction works backwards from what is known to the answer, for example knowing that a needle is metal and hay is flammable, set fire to the stack and in an instant all is gone completely leaving the needle glaringly obvious. Kudos again to this lost art of unfolding knowledge!

Below: Tesla reading his favorite author, Roger Boskovich's "Theoria philosophiae naturalis redacta ad unicum legem virium in natura existentium".

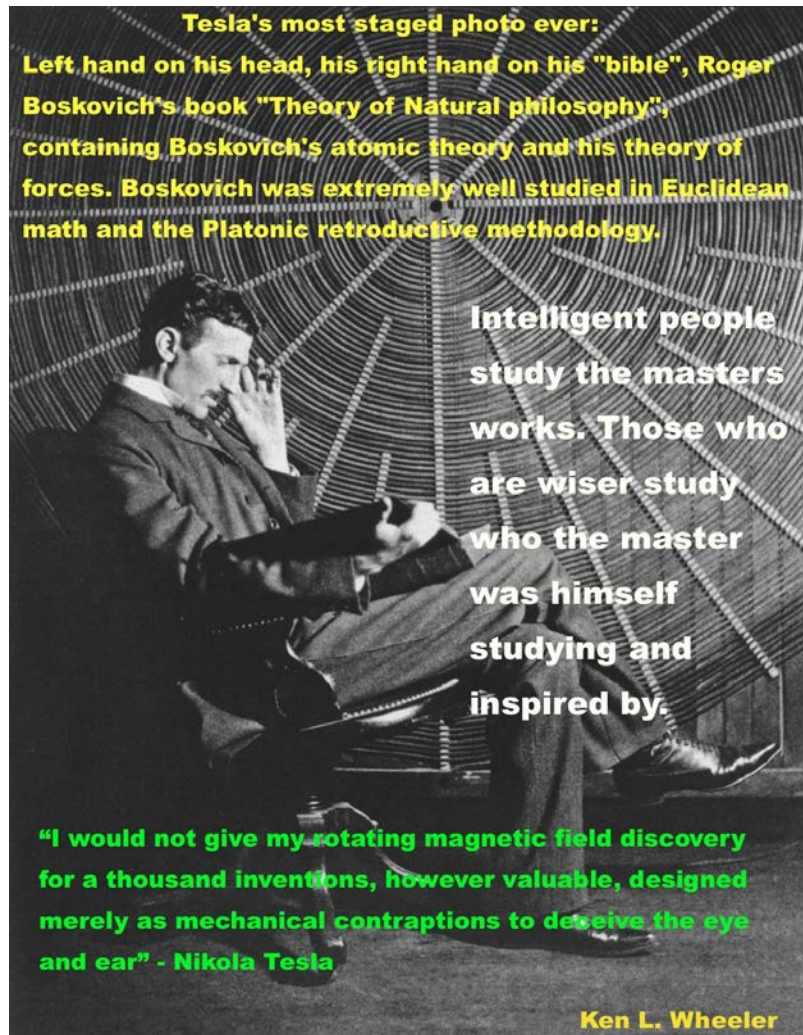

Your TV, cellphone, car, computer, hard drives, absolutely everything you touch or use every day is run off either a permanent magnet or magnetic fields or powered by them at their source; however there is not one person on this earth that knows what a field is, what magnetism is, what instant action at a distance is and what mediates it (since it is by particles). We use, replicate, make, and utilized magnets on every corner of the earth and yet all that is present are descriptions of the nature of magnetic uses, but not a single logical or rational explanation of what magnetism actually is. The world is long in descriptions, for which even a child can accomplish. True genius arrives where explanations begin and descriptions end. The 'how' and the 'why' have eluded humanity on magnetism for far too long. Most amazingly to myself and not to the other lemmings of the world is that magnets are found in every device we use, our cars, phones, televisions, hard drives, headphones, the list in utterly stunning and without end but we are either free not to care or too busy to bother to understand. We, as peoples reproduce magnets and use then in enormous quantities but have no idea what they are. Typical of humans, we learn how to use and reproduce something helpful we stumble across thru the ages, but could care less how it works, and what it really is.

From childhood to adulthood, magnets have fascinated man. Young children are given sets of magnets to play with, linking them end-to-end. School children are shown, with iron ore dust, just how those invisible magnetic lines reach and curl, preparatory to a lecture about the Earth's magnetic field and on to how to use the compass when lost in the woods. The use of magnets so permeates industrialized human society that one would be hard pressed to find an aspect not affected. Lock-free doors secure with magnets, and recyclers separate out metal with magnets, to name but a few. Yet man does not understand magnetism, though theories abound. It's clear that something flows, but just what is flowing is (was) unknown. It's clear that direction is important, but just what is dictating this direction is unclear. It's clear that magnetism occurs naturally, especially in certain ores such as loadstone iron, but what it is that is special about iron ore is a puzzle.

People today ignorantly assume and think you need a multi-million dollar lab to make groundbreaking discoveries. These same fools should be reminded that Tesla, who invented much of the modern world we live in, did not have a Radio Shack or electronics store to go get parts from. Tesla was working with raw steel, copper, wood and wire. He used his keen mind and deductive mental prowess and great reference materials such as Roger Joseph Boscovich's "Theory of Natural Philosophy". The same holds true for Faraday, Steinmetz and Edison. Sharp minds with razor-like deductive capacities solve great mysteries. We still today use the works of Newton who had only his brain, pen, paper and his writings from same. NASA uses these same scribblings to correct for gravity in guiding a satellite to land by remote control on Mars. Great discoveries come from greater minds, not from a particle collider costing many billions of dollars. Humanity may some day learn this lesson.

When the supposed 'expert' and Hollywood-scientist and academic fraud Richard Feynman was asked to explain what magnetism is, how it works, sitting in his chair, he twitched and squirmed like a frog on a hotplate, wiggling and dodging the question, then deflects, and finally says its too complex (for mere mortals) to understand. Eventually he concedes he cannot explain these "forces". This rather infamous video of a worm on a hotplate can be found everywhere. Likewise, his book so highly praised by his hubris filled academic stooges, "QED strange theory of light and matter" explains magnetism away with angels and unicorns, or rather I should accurately say "virtual photons", of which there is no quantitative difference between unicorns and the 'sage' academic explanation of "virtual photons", both are patently absurd and offend even the common sense of a ten year old child and people collectively.

This is all of course is against Feynman's own proclamation that "if you can't explain it to a six year old, then you really don't understand it". In this case, the absurdity of unreal particles and mythical abstractions might be enjoyed conceptually by someone with the mind of a six year old. All these mathematical reifications, sadly, fall in line with the unscientific and irrational mythos of mathematical physics (Greek Atomism in reality) of which one of its key proponents declares "when common sense fails (to explain things rationally), uncommon sense must be created" *L. Susskind*.

IMAGINE A COIN THAT IS INFINITELY THIN. THERE ARE ONLY 3 DOMAINS OF STUDY IN THIS WORLD, IN THIS ORDER: C, THEN B, THEN A. MOST STUDY C AND HOLD THAT ONLY C EXISTS, SMARTER PEOPLE STUDY B, KNOWING IT IS THE PRINCIPLE BEHIND C. WISE PEOPLE STUDY THE FUNDAMENTAL NATURE OF A; AND KNOWING A, LIKewise HAVE A FULL UNDERSTANDING OF B AND C

A IS THE STUDY OF ALL

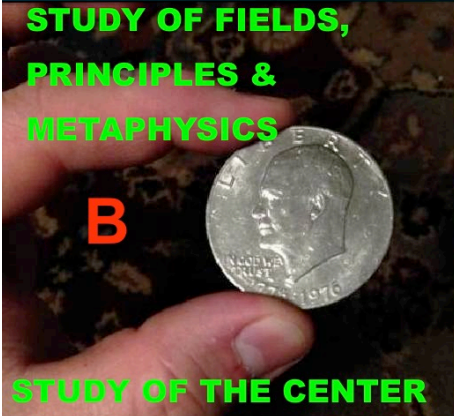
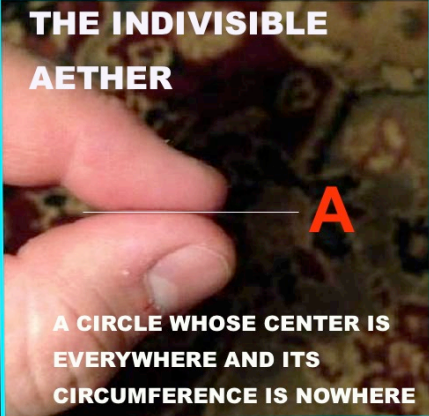
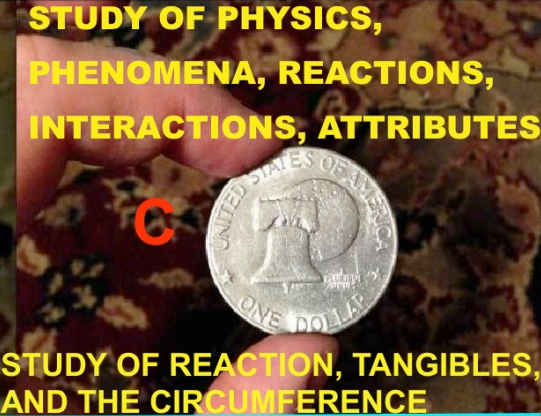
<p>STUDY OF FIELDS, PRINCIPLES & METAPHYSICS</p> <p>B</p>  <p>STUDY OF THE CENTER</p>	<p>THE INDIVISIBLE AETHER</p> <p>A</p>  <p>A CIRCLE WHOSE CENTER IS EVERYWHERE AND ITS CIRCUMFERENCE IS NOWHERE</p>	<p>STUDY OF PHYSICS, PHENOMENA, REACTIONS, INTERACTIONS, ATTRIBUTES</p> <p>C</p>  <p>STUDY OF REACTION, TANGIBLES, AND THE CIRCUMFERENCE</p>
--	---	---

MOST HUMANS ARE FOOLS AND ADMIT ONLY 'C' EXISTS, MORE INTELLIGENT HUMANS KNOW 'B' IS NECESSITATED TO EXIST. THE WISE FEW STUDY 'A' USING THE LOST PLATONIC ART OF RETRODUCTION, APOPHATICISM, THE VIA NEGATIVA METHODOLOGY USED BY ANCIENT WISE MEN TO UNRAVEL THE NATURE OF THE COSMOS

ἀπόφασις

COPYRIGHT 7-2014 Ken L. Wheeler

Nothing was more perturbing and aggravating than watching the demon Richard Feynman sitting in his chair twitching and squirming and fidgeting like a frog on a frying pan when being asked very simplex and logical questions "how does magnetism work?", "how does one magnet attract another, and what is the medium of this attraction?". Finally after flopping like a fish on dry land for an enormous amount of time he states: "I cannot answer it in a manner in which you can understand it or that is familiar to you". That idiots with degrees and acclaim are looked to like the Pope, a clueless fool put on a pedestal, is a timeless human failing, and can be forgiven. However when people assume they know what something is (if they care at all), they do not go looking for the answer to what they already assume they know.

That Feynman and others have declared (as he has done in his mystical book: QED strange theory of light and matter) that magnetism is mediated by “virtual photons” is no different than the Pope declaring mother Marry as healing a sick child from a pendant worn at the neck. Humanity has placed, as dept. chairs in countless universities and likewise, heads of mathematics and physics, people who are quite literally insane, are deep thinkers, but insane ones. The insane asylums of the world are full of genuinely deep thinkers, however it is not for sake of deep thinking they are locked up and away from others! So, taking a cue from Quantum mysticism we then ask the expert (fool) relativist “since you declare magnetism to be mediated by ‘virtual photons’, what is same?”. **Answer received? Yes, here we have it:** “A virtual particle is an abstraction, which facilitates in calculations and understanding, the term is very vague and loosely defined, they never appear as inputs or outputs of experiments, their existence is questionable at best, . . . however they are very useful in rendering concepts and making equations balance out”. Well, insanity has been reified, at last!

Fields! The 800-pound gorilla in the room of quantum mysticism is defining a field, action at a distance both instant and in a vacuum. Owing and pouring through every existing book on action at a distance, there is not one scientist alive or dead who can tell you what a field is without evoking Greek Atomism as an explanation, virtual particles, muons, gluons, gravitons, negative momentum particles and countless other things that do not exist, nor have ever even remotely been proven, and never will be. Its axiomatic, a truism that physics can only do experiments with objects, and irrationally considers only physical objects as “existing”, not in a conventional sense, but in an absolutist sense, therefore physics has no possibility (it never has!) of explaining a field, be it magnetic, dielectric, gravitational, since all fields are Ether-based. The obvious and glaring truth in observation and fact is that fields act instantly over a vacuum, and there are no particles of quantum mysticism mediating any field. Every aspect of energy production in the world is about moving pressures from one place to another, nuclear reactor to move steam pressure, wind pressure for a generator, dielectric pressures from light in solar cells; and yet the cult of quantum and GR refuse to acknowledge that all electromagnetic and gravitational motions, and energy production, or magnetic induction into copper in producing electricity, that all of these are merely Ether pressures. As Dollard has called it, a “mind virus”; it is a comprehensional lobotomy of humanity and its religion of GR and QM.

Physics is the science of existence, but not necessarily the science of truth, only of objective truth (which as any rational person knows is only half or less of the picture), which is not part nor parcel to any field which has no objective existence, no objective reality! The quickest way to hush anyone within the realm of GR or QM (general relativity and quantum mechanics) is to ask him or her what a “field” is, and immediately inform him or her before answering that it cannot involve particles, as this is a well established absolute. There have only been two positions in the totality of history on fields and magnetism, immaterial and materialistic / atomistic. The GR and QM position is purely materialistic, they have not one explanation for a field, they explain away fields, in fact no less, with another field, and their pseudo-argument is purely circular and fallacious; at best they evoke non-entity particles to rationalize fields as the means and mediators of fields, however of course this is impossible in the vacuum of space and at the superluminal speeds in which some fields operate. Typical of GR and QM insanity, fields and the Ether have been replaced with an insane reification of ‘warped spacetime’. While most historical immaterial explanations for fields have been surrealistic, hyper-mystical, magical, the fact remains that all fields are Ether in nature, they are also rational, logical and these are the very same conclusions drawn by Tesla, Steinmetz, Heaviside, and Maxwell (among many), and the only conclusions that explains fields, dielectricity, magnetism, gravity, electricity and countless other rational, logical experiments and observations without end.

The notion that magnetism is a “quantum mechanical effect” is pure nonsense, additionally that there are ‘electrons moving’ which resultantly creates magnetism; this is absurd, contrary to facts and observation. As any ‘scientist’ will tell you, nobody has ever ‘seen an electron’, as discussed further on, this is the premise of the greatest minds of electrical theory as well, Tesla, Heaviside, Maxwell, Steinmetz and others. Typical of GR and QM, they have reified unreal abstractions and concepts (muons, gluons, electrons etc.), things that utterly do not exist, and thoroughly dismiss reality, that being fields and the Ether. Rationally one must ask themselves that since the greatest inventive minds to exist and which created our entire electrical world, Tesla, Maxwell, Steinmetz and others, if these great minds embrace the Ether as reality, and academic fools who invent nothing and only create fictional works vociferously deny it, which side is the more rational and sane?

When starting down this road some long time ago, I would have wished that magnetism was a unique force unto itself, a principle of its own, however that was not to be! Magnetism is radiation, is definitionally the “dielectric field”- Faraday (and Maxwell). Radiation does not “attract” radiation (the ever-held false view that magnets “attract” or “repel” each other due to magnetism, is wholly wrong). Polarization, space (resultant to a field), radiation, CW/CCW, divergence are all synonymous with what magnetism is definitionally. However while not ‘let down’ that magnetism was not a “unique principle”, just another modality of the Ether (as are all four forces are), a deep understanding dawned and with this came an enormous flowing discovery like a floodgate came forth of both invention, understanding, and the ability not to just to describe (which any fool can do), but to explain and genuinely grasp all which was occurring, the why, the how, etc. was all painted in perfect clarity.

“This medium of propagation, the Ether must exist. This medium must be a prominent thought in our investigations” **Treatise on Electricity and Magnetism – J.C. Maxwell**

The universe is simplex but not simple, there are no ‘zero sized particles’ mediating magnetism, or fantasies that only exist in the minds of GR and QM priests. Like a bar of steel which can be at various lengths creating various tones like a xylophone, or circular, or tubular, in motion, moving centripetally or centrifugally, all such phenomena, nearly endless, can be reproduced by the size, geometry, movements of what we started out with, a standard bar of iron. The universe is divinely simplex (but not simple), with only three components, the Ether, mass particles, and fields (all of which are Ether in principle, and the particles themselves are stable dielectric conglomerations and Ether-based). Everything else is tones, overtones, geometry, and movements, spatial and counterspatial, centrifugal and centripetal. Ironically, the fools of quantum mysticism have created a pantheon of irrational virtual nonsense (gluons, muons, gravitons, electrons, quarks, virtual photons, zero-sized particles), and yet these same academic fools accuse the greatest minds who lived, Tesla, Edison, Steinmetz, Heaviside, Maxwell, and countless others who declare all is impossible

“without the Ether”, to be the irrationalists! The facts are irreducible, the great minds of Tesla, Steinmetz and others invented everything upon which the modern world runs and loves dearly in daily use; likewise the pendants, the mystics of GR and QM produce only nonsense, pontifications, insane theories without a logical hypothesis to begin with and fantastical books that make Alice in Wonderland seem perfectly plausible by comparison. The mystics of GR and QM have so convincingly played their parts in producing “new particles” and other unreal objects (which have never been witnessed or appear as the outputs of experiments) that they have not realized in the slightest that all such names given are but reifications attributed to different states and modalities of Ether based pressure movements and likewise Ether field modalities (gravity, mass, magnetism, dielectricity).

And I will explain to you the “Wheeler Principle” of magnets, that being **point non-specific self-similarity**; the finally explained incommensurability of the coherent magneto-dielectric system of a magnet, which lucidly and logically explains how magnets operate one and for all, with proofs, formulas, and irreproachable logic. The magnetic vortex and mutual field reciprocation does indeed exist in the so-called magnet (I will explain this further on).

“Beware of false knowledge, its more dangerous than ignorance” -Shaw

Irrationality defined: “an explanation that a proponent cannot imagine, explain, or illustrate”

Below: Look at these, and I will explain them a bit later. Remember where science has and does fail most miserably today and hence, is giving names to phenomena and descriptions of them, but a total incapacity to explain them. Descriptions are not explanations!

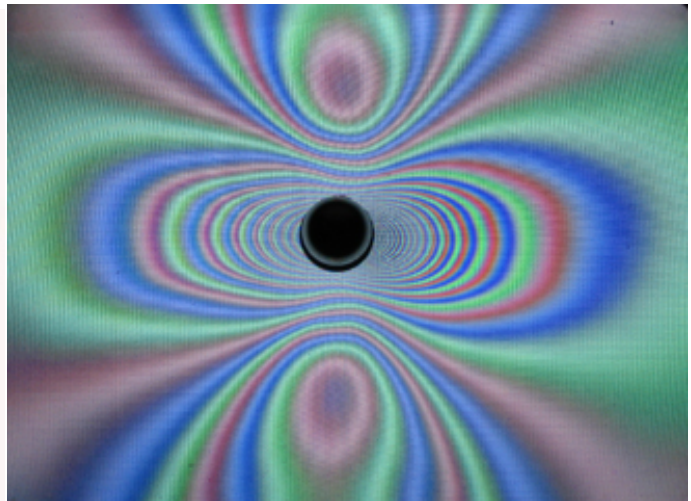
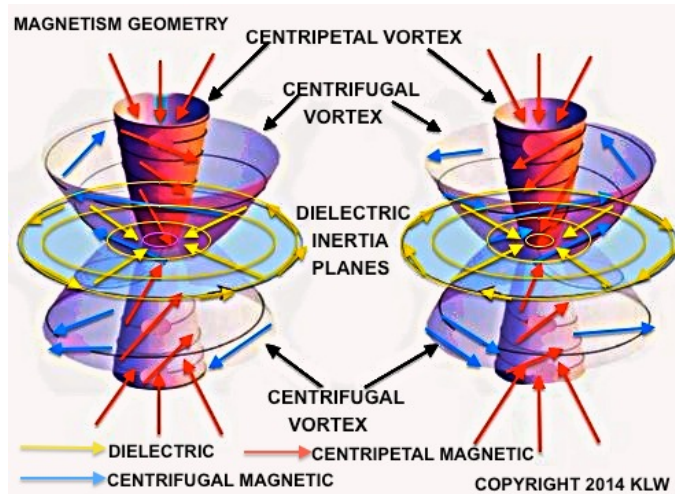

A very brief historical glimpse of earliest magnetic comprehension

“Mother Nature does not calculate, does not do math, she only knows of three pairs, spatial-counterspatial, centrifugal-centripetal, and charge-discharge. With these three conjugates, the entire cosmos is painted in full detail. Phi is to 1, as 1 is to Phi, understand this fact, or you will understand nothing.” – Author

“If you were to reveal the dielectric inertial plane of a magnet with field viewing film to an ancient Platonist, or ancient Egyptian metaphysician, at which there is no magnetism present between the two “poles”, he would proclaim forthwith that this was the universal fulcrum sitting at the middle of all space, antinomies, and becoming. But a modern fool existentialist, an Atomist calls this a ‘Bloch wall’, or domain wall. Descriptions and names are not explanations or understanding, or comprehension. Dielectricity is the fundamental Ether-modality of the entire cosmos.” - Author

“If anyone, not knowing, were to ask why magnetism moves the way it does, the most simple and true answer would be that ‘it cannot exist any other way’. Nature does not move against higher pressures or motions with a lower moving pressure unless the lower pressure accelerates all pressure voidances between the two or moves in a counter-operational spin and therefore does not ‘exist’ on the same plane as the higher pressure it moves against. The free space compressibility of the Ether is different than the compressibility of same as conjugated atomically in the dielectric and the magnetic bounding volumes. From this fact, all things possible are seen.” – Author

Below: These popular images of iron filings over bar magnets are mostly wrong, we will learn why a bit later

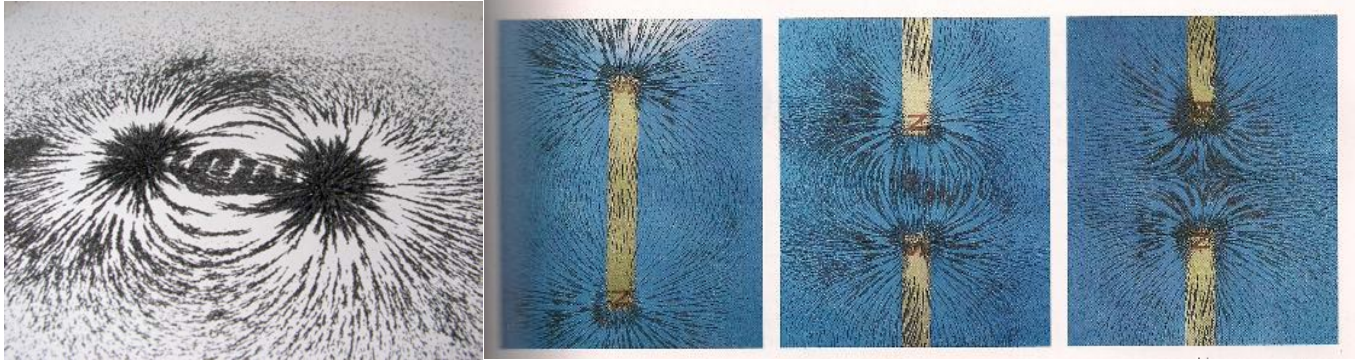

This history of magnetism is the very likely to be certain the origin of the word ‘magic’ itself; these histories of magic, based in the Hermetic tradition, suggest that knowledge of the magnet originated with the Magi, plural of magh, or magus, who were the first to discover its attraction as witnessed in loadstone iron. Consequently, the “magical” loadstones were named in their honor. The word magnet deriving from the Sanskrit root word, mahaji, (maha+jhayati) meaning the great or wise, but specifically meaning “has magic” (in ancient days wisdom was magic and vice versa). The Egyptians believed the sky to be made of iron or steel, namely, obviously due to iron meteorites; hence the name for iron, metal of heaven. Meteoritic iron, which was, early on, famous from loadstones with their “magical attraction”. The very same thing Muslims pray to every day is a broken up meteorite embedded into the kabbah in Mecca; yes, Muslims are bowing down in prayer to a broken up iron meteorite. The “magic stone from heaven”.

Once again as in other matters, and almost ironically, the ancient Greeks had a firmer grasp on the nature of magnetism than does the modern quantum mystic. From Plato we have: “Other examples are any stream of flowing water, the fall of thunderbolts, and the puzzling attraction of amber and loadstone.” –**Plato**. “In fact there is no attraction. Proper investigation shows that there is no void and that circular thrust operates in all these instances; the various bodies part or come together in the course of mutual interchanges of position and what seems like magic is due to the complication of their effects on each other.” –**Plato**. “Circular thrusts”, even the ancient Greeks knew about the circulatory nature of magnetism! Retroductive logic is so powerful that the Greeks (who knows to what great extent) knew what magnetism was vaguely (at least that it was field induction by mediation, which is not materialistic), while not in specific, they still understood this thousands of years ago.

“Really, as I said just now, this is no art in you to speak well about Homer; no, some divine power is moving you, such as there is in that stone which Euripides called the Magnesian, but most people call it the Heracleian stone. This magnet attracts iron rings, and not only that, but puts the same power into the iron rings, so that they can do the same as the stone does; they attract other rings, so that sometimes there is a whole long string of these rings hanging together, and all depend for their power on that one stone. So the Muse not only inspires people herself, but through these inspired ones others are inspired and dangle in a string.” –(**Socrates on magnets ION 535e**). From this we know that Socrates and who knows how much further back before him knew what magnetic induction was. In using the analogy of magnetic induction to speak of the muses who can, at a distance by immaterial (incommensurable!) means influence and move things to do action. “Thales, too, to judge from what is recorded about him, seems to have held the soul to be a motive force, since he said that the magnet has a soul in it because it moves the iron.” (**Aristotle on the Soul. De Anima, 405a**). Epicurus who writes the following explanation for the action of the magnet: “The lodestone or magnet attracts iron because the particles which are continually flowing from it, as from all bodies, have such a peculiar fitness in form to those which flow from iron that, upon collision, they easily unite.” - **Epicurus (342-270 B.C.)**

Below: The ancient object behind much scientific investigation and mystery, the loadstone



“Why the Heraclian stone attracts iron. Empedocles says that the iron is borne towards the stone by the effluvia emanating from both and because the pores of the stone are fitted to receive the effluvium of the iron. The effluvium of the stone then expels the air from the pores of the iron. Once the air is expelled, the iron itself is carried along by the abundant flow of the effluvium. Again, when the effluvium of the iron moves towards the pores of the stone, which are fitted to receive it, the iron begins to move with it.” - **Empedocles of Akragas (491–435B.C.)**. This was from the second hand account of Alexander of Aphrodisias who paraphrases Empedocles theory. As today, as was before, there are only two explanations for magnetism, one materialistic and mechanical (as above, evoking particles, nonsense, reifying space as a mediator), and the other immaterial, based in fields, the Ether (Platonic and Pythagorean in nature). This Atomistic / materialistic insanity contrasts with the Thalean theory, which attributes the attraction to a non-materialistic, hidden, and immaterial cause, or field mediator. As it was in ancient times so it is today, that these two views constitute the only two main positions used to construct theories of electricity and magnetism throughout the “prescientific” and “scientific” (irrational) eras. All the theories constructed since the days of the ancients can be classified as either materialistic, based on the action of ‘effluvia’ in the form of tiny insensible particles (same as the nonsense of GR and QM today, their ‘virtual photons’), or as mediated by immaterial fields, and forces of attraction that act at a distance across the intervening space and vacuum. Of course only the later is correct, logical, sensible, and the position of all the great minds who invented most everything the modern world worships and uses on a daily basis.

Another ancient materialistic view of magnetism: “Democritus also says that there are effluences and that like bodies are attracted to like, but adds that all are attracted to a void. Having made these hypotheses, he supposes that the loadstone and iron consist of similar atoms, but those of stone are smaller and it is of some rarer texture than the iron and contains more void. For this reason, its atoms being more mobile are attracted more quickly to the iron (for they are moving to their similars), and entering the pores of the iron disturb the atoms in it as they pass between owing to their small size. The atoms of the iron, thus disturbed, stream outside towards the stone because of their similarity and because it has more void. The iron [as a whole] follows them in their wholesale expulsion and movement and is itself drawn towards the stone. the reason why the stone does not move any more towards the iron is that the iron does not contain so much void.” – **Democritus (according to Alexander of Aphrodisias who is the source on this quote)**

At one period in history, loadstones sold and traded for their weight in gold, and were used by traveling magicians to impress the common fool as to his ‘magic’ powers in creating or evoking magic rocks that could make iron fly from rest to these ‘magic stones’.

Electron nonsense, dismissing the ‘discharge particle’ fallacy

“If you want to find the secrets of the universe, think in terms of energy, frequency and vibration (not matter).” - N. Tesla

The two greatest sins committed in so-called science in the past hundred years are convincing the ignorant many folk to believe that: 1. Space and time are genuine entities rather than conceptions and attributal abstractions; and that they mediate action at a distance and are the medium or field itself. 2. The fantastical invention of virtual particles, and massless beads that mediate gravity, light EM, and magnetism. Such nonsense offends the mind of even a drunkard and a child. Concepts and non-existent particles have no place in the mechanics of the cosmos or of rational physics.

“A deep thinker (GR and QM) who cannot see clearly takes a sonar image of the turbid waters of the sea floor, recording its image, then moments later takes another image and seeing new masses on the bottom from the sonar image declares such bumps ‘evidence of sea-floor shifting, a possible newly forming volcano’. The clear thinker can see the remaining 99% between the surface and the bottom of the sea and informs the insane deep thinker that those bumps are whale shit.” - Author

“If you cannot explain the laws of physics simply, to a bar maid, then you don’t really understand them yourself.” –Einstein

*“What Tesla accomplished is the greatest discovery in mankind. The transmission lines you see everywhere, along the roads in every place you go, these allows us to have a giant drive shaft that we can take rotary motion from like a massive turbine plant and convey it thru an electromagnetic structure that operates with reflected waves and time frames. This work just like a drive shaft, it bounces back and forth, twists, and rotates. But you can stand outside and look at those thick power lines that go down any public street and in the space between those lines, the energy there is the energy of a giant railroad locomotive moving at 95% of the speed of light down the space between those wires, and there is no evidence that anything at all is happening except that the wires are slightly pushed apart and warm. **So it’s a type of drive shaft that exists in another dimension.** Then you put the synchronous machine on the other end (of that power line) and you couple out of that (electrical) drive shaft like a transmission and you have rotary force again. These things (rotary Tesla generators) are no more than stamped iron in patterns. By making this special arch form and its influences on the formative forces in the Ether ...Tesla’s invention is the most powerful arch form the human race has ever conceived.” – Eric P Dollard*

Nikola Tesla November 1928 interview:

*On the whole subject of matter, in fact, Dr. Tesla holds views that are startlingly original. He disagrees with the accepted atomic theory of matter, **and does not believe in the existence of an “electron” as pictured by science.***

“To account for its apparently small mass, science conceives of the electron as a hollow sphere, a sort of bubble, such a bubble could exist in a medium as a gas or liquid because its internal pressure is not altered by deformation. But if, as supposed, the internal

pressure of an electron is due to the repulsion of electric masses, the slightest conceivable deformation must result in the destruction of the bubble! Just to mention another improbability...” - Nikola Tesla

Article: “A Famous Prophet of Science Looks into the Future” (Popular Science Monthly)

Electricity is utterly a mass-free phenomena, as mentioned by many including Dr. Wilhelm Reich in his “Cosmic Superimposition”. Mass has no logical or theoretical place in electrical units and all particle-based conceptions of it are impossible. There is no mass in T.E.M. (transverse electromagnetism).

Mother nature has never taken a course in math, algebra and she absolutely rejects the nonsense espoused by quantum. ‘She’ knows only about charge-discharge, spatial-counterspatial and centripetal-centrifugal spin as binary conjugates to charges and discharges. Gravity, electromagnetism and matter are all modalities of the Ether, of charges and spin. There are no negatively "charged" particles in this universe. Negative electricity discharges while positive electricity charges. The negative depolarizing force functions in the opposite manner and direction to the positive polarizing force. There is no such condition in nature as a negative charge, only discharges, nor are there negatively charged particles, further still not one iota of proof for same. Charge and discharge are antinomies, as filling and emptying, or compressing and expanding are mutual and co-eternal principle conditions. The commonly held belief in nonsense such as the notion that electricity is a stream of rolling electron beads thru a conductor is one of the most insane conceptual reifications of the definition of discharge as held by so-called intelligent minds.

There are no electrons, negative charges, special-dimensions, warped space (resoundingly denied by Tesla and others), and no photons; only charge, induction and radiation/discharges and their relational spins, all as mediated thru the Ether. Quantum and Relativity is a quack religion of mathematical physics based upon the absurd premise that the universe is a giant sea of interactive massless tiny invisible beads and that space itself, nothing, mediates interactions and can be genuinely ‘warped’. Such conceptual Atomistic reifications as amplified by GR (Relativity) cannot be enjoined, and the only genuine warping occurring is not out in the cosmos of space, but in the empty spaces between the ears of those who reify such absurdities; warped minds rationally would invent warped space; its purely logical in its insanity that the former produce the later.

Space has only one dimension, space, which is a metrical dimension. The use of cubic notation is habit-based, any number of co-ordinates in any number of geometries can serve to define the boundaries of space. **Nature is not governed by the irrational pontifications of GR and QM, rather it is governed by mutually interactive reciprocal conjugates of charges-discharges, centripetal-centrifugal movements, both spatial and counterspatial. Instantaneous action at a distance, and fields are all Ether modality mediations as propagated by counterspace-in-disturbance, the Ether, its pressure gradients and perturbations. No other mediator can be logically hypothesized, much less theorized. The very same Ether of Tesla, Heaviside, C.P. Steinmetz, and even originally from Einstein before logic fled his mind completely, was correct and remains so. Tesla outright denied our current definition of the electron as a ‘discharge particle’.**

All electrons are a motional terminus of a quantity of dielectric pressure gradients of force (as reified by the incorrect understanding of the definition of a ‘field’), these pressure gradients, or “lines” are contracting and stretching like rubber bands, giving motion to the terminus ‘electron’. The thermionic ‘electron’ contracts, pulling the ‘electron’, the cathode ray stretching, pulled by the ‘electron’. In the former case the lines of force are dissipated, in the latter case the line of force are projected, in both cases these so-called ‘electrons’ assume radial motions, with non participating pressure gradients, or forces filling the ‘voids’, directing the ‘electrons’. Hence, it is the so-called ‘electrons’ (dielectric radial discharges) that travel in straight lines, that is, radially. **‘Electrons’ have nothing to do with the flow of electricity; the so-called ‘electrons’ are the rate at which electricity is destroyed. ‘Electrons’ are in fact the resistance. From** extensive experimental work into atomic electrical science by J. J. Thomson, and Nikola Tesla, it is established that the so-called electron is only a shadow; its apparent-only physical mass is merely an electrical momentum (ejected by the dielectric inertia in disturbance). There is no rest mass to an electron nor could there be logically, a rest-electron ‘bead’; such notions are absurd and evidence proven non-existent. The very premise is logically impossible and contradicts the rational physics of atomic charges and discharges.

“In the theoretical treatment of these electrons we are faced with the difficulty that electro-dynamic theory by itself is unable to give an account of their nature.” “For since electrical masses constituting the electron would necessarily be scattered under the influence of their mutual repulsions, unless there are forces of another kind operating between them the nature of which has hitherto remained obscure to us.” - **Einstein on electrons; “Relativity”, by Albert Einstein, Random House Publisher, 1916**

There is no such condition in nature as a negatively charge particle nor could there be. Charge and discharges are opposite conditions of a single subject, either protons or fields of movements and radiation of those same electrical fields. To claim that liquid in a jar (charged) is one thing, and pouring that liquid from the jar (discharge) is another liquid altogether, is nonsense, likewise compression and expansion are opposite conditions of a single subject. Compressing bodies are charging into higher potential conditions. Conversely, expanding bodies are discharging into lower potential conditions.

“To describe an electron as a negatively charged body is equivalent to saying that it is an expanding-contracting particle. There is no such condition in nature as a negative charge, nor are there negatively charged particles. Charge and discharge are opposite conditions, as filling and emptying, or compressing and expanding are opposite conditions.” – **W. Russell**

Thomson developed the “Ether Atom” ideas of M. Faraday into his “Electronic Corpuscle”, this indivisible unit. One corpuscle terminates on one Faradic tube of force, and this quantifies as one Coulomb. This corpuscle is not an electron, it is a constituent of what today is known incorrectly as an “electron”. (Thomson relates 1000 corpuscles per electron) In this view, that taken by W. Crookes, J.J. Thomson, and N. Tesla, the cathode ray is not electrons, but in actuality corpuscles of the Ether.” – **E. Dollard**

With the introduction of the so-called ‘electron’ by Thomson and the supposed debunking of the Ether theory, **the golden age of electrical discovery ended.** Tesla's Wardencliff tower was demolished. His work and that of other Ether researchers fell into disrepute. They were relentlessly attacked by mainstream science, something that continues to this day. As a result, the days of Ether-

driven, electrical discovery petered-out, finally ending around 1930. As a direct and intentional result of the academic physics theory, the methodology behind the brilliant inventiveness of previous generations was all but wiped out and replaced by an unproductive particle physics. This, from the cult of quantum, a fraudulent collusion and academic hubris-based pseudo-conspiracy based in “deep thinking insanity” designed by mathematical physics.

I must give exclusions to quoting Walter Russell in any length and frame him properly, lest there is a misunderstanding as I have noticed from prior editions of this work and its reaction from Russell cultists, while he was roughly 75% accurate in his positions, his 25% or so of inaccuracy is stunningly demented, namely his rejection of the Ether and his incapacity to differentiate electricity from dielectricity among many intellectual conclusions and failure Russell committed; dropping out of school at the age of 9 (essentially utterly no education whatsoever) did him harm ultimately. His dogmatic cult-like followers have deified Russell to a personality-cult figurehead and they are rather an insane and rabid lot of moonbats. As an ancient philosopher once said “I will give him great praise for his accuracies, but I will not do so on his failures.” Blind dogmatic “all or nothing” devotion to the ‘deified dead’ as regards Russell or anyone is the realm of cultish maneuvers which cannot be intelligent or logically supported. Such rabid insanity can be seen of followers of Russell, Einstein, Feynman and a few others. The difference being of course that Russell was roughly 80% correct, whereas Einstein and Feynman were 80% wrong.

Stunningly important is the fact that **Walter Russell never and at no time defines, or attempts to even broach the topic of what a FIELD is.** Having digitized his works and making quick work of a word search of ‘FIELD’ will reveal absolutely nothing whatsoever in his three main works. As I have taught many people, you can tell more about what someone doesn’t say than what they do say. Absence is as strong or stronger than presence. Any incapacity to define the term FIELD an utter incompetence and abysmal failure of the absolute highest magnitude. Everything is fields, absolutely everything; as such an absolute failure to broach the topic is a monumental failure that must be pointed out. However he is far from alone in this titanic omission. While there are a handful of occurrences of Russell’s in which he mentions ‘wave-fields’, this is utterly meaningless and left unqualified. Waves of what, fields of what? Waves are phenomena of prior subjects or principles, are merely qualifiers and not explicative of anything in definition. We seek answers here, not pathetic descriptions and pontifications.

Below: The cult of quantum, so heavily railed against by Tesla, Heaviside, and others was to overthrow rational thought and science. Thankfully though, not forever. This epoch of mass-insanity will be a footnote to future discovery and genuine science.

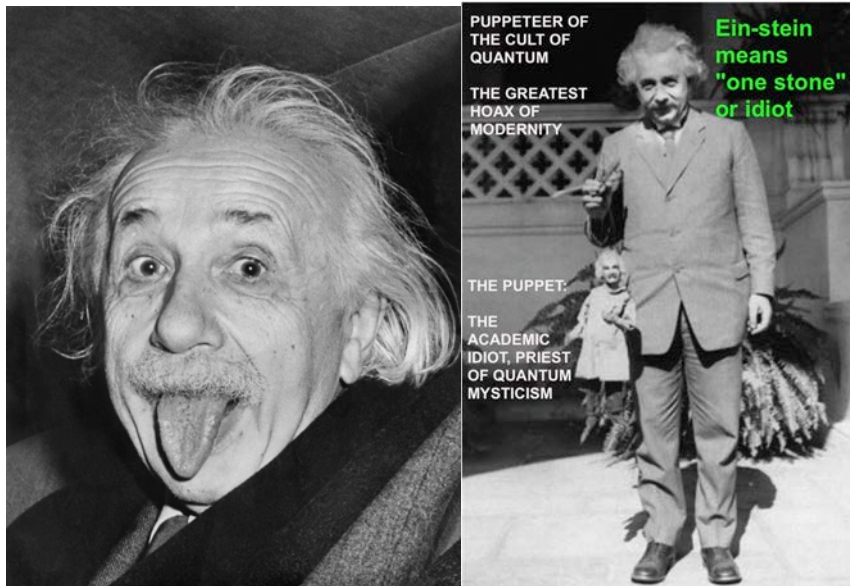

The waveform of supposed “electron” flow is the same waveform produced when you slam on the brakes. It’s a harmonic sine wave and the sound of energy dissipation. Electricity flows in the space between the wires. This has always been known by electrical engineers. For example, if you short out a major electrical circuit you will see the cables violently repel each other as the electromagnetic force tries to escape from the boundaries in which they are contained between the so-called bounding conductors. The power is between the conductive wires, not in them, nor are there electrons ‘beads’ bumping or flowing thru the ‘conductor’.

In general, the electrostatic potential, e , in Volt, renders the insulators hot, the magnetomotive force, i , in Ampere, renders the wires hot. Also, it is found that this heating increases with increasing frequency of the potential, e , or the M.M.F., i . It is here where the prevailing concept of the “electron” is to be found. Hence it is the motions of the so-called electrons that give rise to the energy loss in an electrical system. “Electrons” represent energy dissipation. However, the cult of quantum, and the ill informed fool all tell us that the ‘electron’ is a subatomic particle and charge carrier, and is that which conveys energy, this is complete irrational nonsense!

“Maxwell’s discovery of a factor of proportionality between dielectricity and magnetism led to his theory of conjugate pair of inductions, dielectric and magnetic, in union, propagating at the velocity of light through the ‘Luminiferous Ether’. Hence, electromagnetic waves in free space, unbounded by gross physical matter, mass free energy. This propagation is within the dielectric, or Etheric, medium itself. It is free of so-called “charge carriers” (electrons), a mass-less form of electricity. This concept had a very powerful impact upon the scientific and philosophical thoughts of Maxwell’s era. So here begins the notion of “wireless”, the

transmission of electricity without wires or other guiding structures.” – **E. Dollard**

“There is no rest mass to an ‘electron’. It is given here the ‘electron’ is no more than a broken loose “hold fast” under the grip of the tensions within the dielectric lines of force. They are the broken ends of the split in half package of spaghetti. Obviously this reasoning is not welcome in the realm of Einstein’s Theory of Relativity.” – **E. Dollard**

“This gaseous Ether is the seat of electrical phenomena through the process of its polarization. This polarization gives rise to induction, which then gives rise to stored energy. Tesla gives a good presentation of his Ether ideas in his “Experiments with Alternate Currents of High Potential and High Frequency.” Mentioned previously, the Planck, Q , as the primary dimensional relation defining the “Polarized Ether”, this as an “Atom of Electricity”. It is however, from the views of J.J. Thomson, the Coulomb, ψ , the total dielectric induction is the primary dimension defining the “Polarized Ether”. The lawyer like skill of today’s theoretical physicist (Pharisee) has erased this understanding from human memory, it is henceforth sealed by the Mystic Idol of Albert Einstein. If Einstein says no, then it is impossible. What a nice little package.” – **E. Dollard**

“Unfortunately to a large extent in dealing with dielectric fields the prehistoric conception of the electro-static charge, the ‘electron’, on the conductor still exists, and by its use destroys the analogy between the two components of the electric field, the magnetic and dielectric. This makes the consideration of dielectric fields unnecessarily complicated” - **C.P. Steinmetz (Electric Discharges, Waves and Impulses)**

The idea of electricity as a flow of ‘electrons’ in a conductor was regarded by **Oliver Heaviside** as “**a psychosis**”. This encouraged Heaviside to begin a series of writings

“Electrons as a separate, distinct entity...doesn’t really exist, they are merely bumps in something called a ‘field’.” - **Dr. Steve Biller**

“Here we will dispel the "electronics nerd" concept that a capacitor stores "electrons" in its plates. Taking the pair of copper plates as in the previous experiment, but now we have two pairs of plates, one pair of plates distant from the other pair of plates. Upon one pair of plates is imposed an electro-static potential between them. The cube of 10-C oil is inserted between this "charged" set of plates. This hereby establishes a dielectric field of induction within the unit cube of 10-C oil. Now we then remove this cube of oil, withdrawing it from the space bounded by the charged pair of copper plates, and taking this unit cube of oil, it is then inserted into the space bounded by the other uncharged pair of plates. Upon insertion it is found that the un-charged pair of plates have now in fact become charged also. It here can be seen that a cube of dielectric induction can be carried through space, from one set of plates to another set of plates.” – **E. Dollard**

Also consider the **J.J. Thomson** concept of the "electron" (his own discovery). Thomson considered the electron the terminal end of one unit line of dielectric induction.

“The notion exists that the electro-motive force, E.M.F. in volts, is established by “cutting” lines of magnetic induction via a so-called electric conductor. This “cutting” is then said to impel the motions of so-called electrons within the conducting material. It is however that a perfect conductor cannot “cut” through lines of induction, or flux lines, Φ . Heaviside points out that the perfect conductor is a perfect obstructor and magnetic induction cannot gain entry into the so-called conducting material. So where is the current, how then does an E.M.F. come about? Now enters the complication; it can be inferred that an electrical generator that is wound with a perfect conducting material cannot produce an E.M.F. No lines of flux can be cut and the Ether gets wound up in a knot. Heaviside remarks that the practitioners of his day “do a good deal of churning up the Ether in their dynamos”. – **E. Dollard**

You cannot say that stretching a trillion rubber bands nailed to the floor and releasing them or breaking their “force lines” is the “flow of electrons”; discharge is a terminal movement in systems of inductance or dielectric capacitance. There are no discrete particles in the universe and certainly none that mediate charges, discharges, magnetism, electromagnetism, gravity, and radiation, only fields, all modalities of the Ether. The so-called ‘electrons’ are not particles, not objects or subjects but are the dynamic principle of discharge, and are certainly not charge-carriers, fields are not particles, are not “electrons”, nor assuredly are there energy discharges in the vacuum of space involving ‘electrons’; the ‘electron’ is a fiction of fallacious observation and an even more faulty mental acuity, spawned naturally from the minds of materialists, or an Atomist. Electricity is Ether in a state of dynamic polarization; magnetism is Ether in a state of dynamic circular polarization upon itself, is the radiative termination of electrical discharge; dielectricity is the Ether under stress or strain. The motions and strains of the Ether give rise to electrification. Φ times ψ gives Q ; ‘electrons’ do not mediate these electrical and magnetic forces or their likewise the Ether fields.

Microwave beaming of massive amounts of power to a satellite and back to earth is feasible and being looked into by the military, this is the transmission of mass-free dielectricity in the form of dielectro-electromagnetism (TEM), incorrectly deemed “electromagnetism”. Waveform beaming between dipoles, laser induction energy transfer, all mass-free. Solar cells in space, the possibilities of wireless mass-free energy transfer are nearly endless. Inductions and fields mediate charges and discharges, not particles!

In this technology (below) two coils are placed at a distance. Current is passed through one coil and a magnetic field is generated. Now, if the second coil is present within the magnetic field of the first coil a magnetic field will be generated in the second coil too. If however the second coil is outside the range of the first coil no magnetic field will be produced and so no power will be transmitted. This method is used to charge electric toothbrushes.

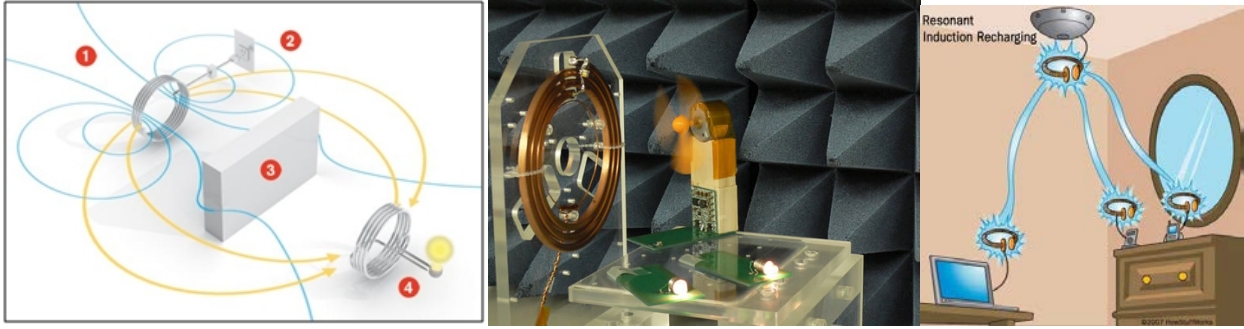

Below and above: New developments in wireless recharging technology are being developed that will allow the charging of multiple devices at the same time without needing wires using magnetic resonance (right illustration). On the left, another company is using antennas to beam form electromagnetic energy to remote devices up to 15 feet. The powered wireless router tracks the devices and beam forms the electromagnetic energy to the device to charge it.

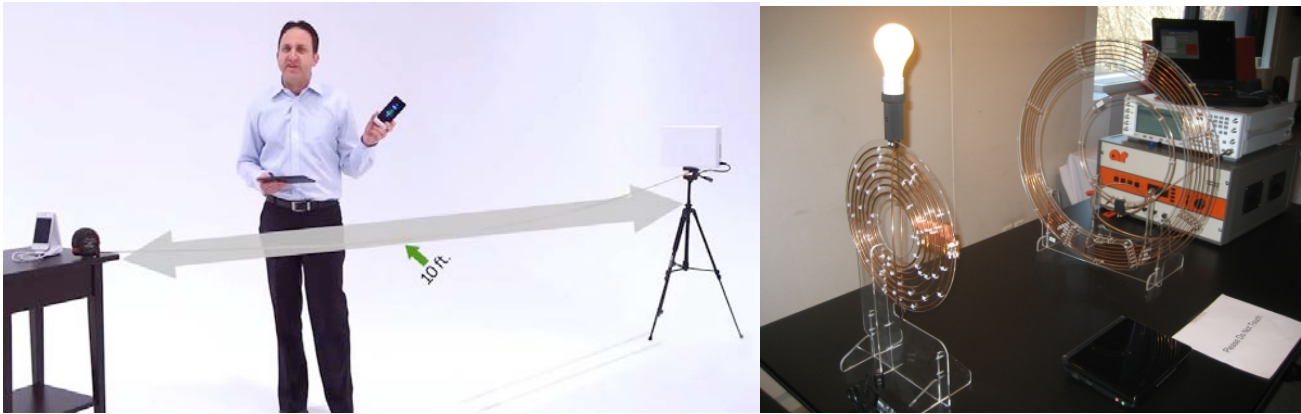

Below: However visions of turning your house into a giant magnetic resonant induction-charging device are not to evolve nor wires to vanish from homes for power consumption. In truth such a magnetic bubble cranking endless magnetic field lines thru your house would both drive you insane, cause mental visions, headaches and likely make your cat foam at the mouth and turn your dog schizophrenic. Not a situation to transpire given the side effects of going “wireless” for home based power consumption.

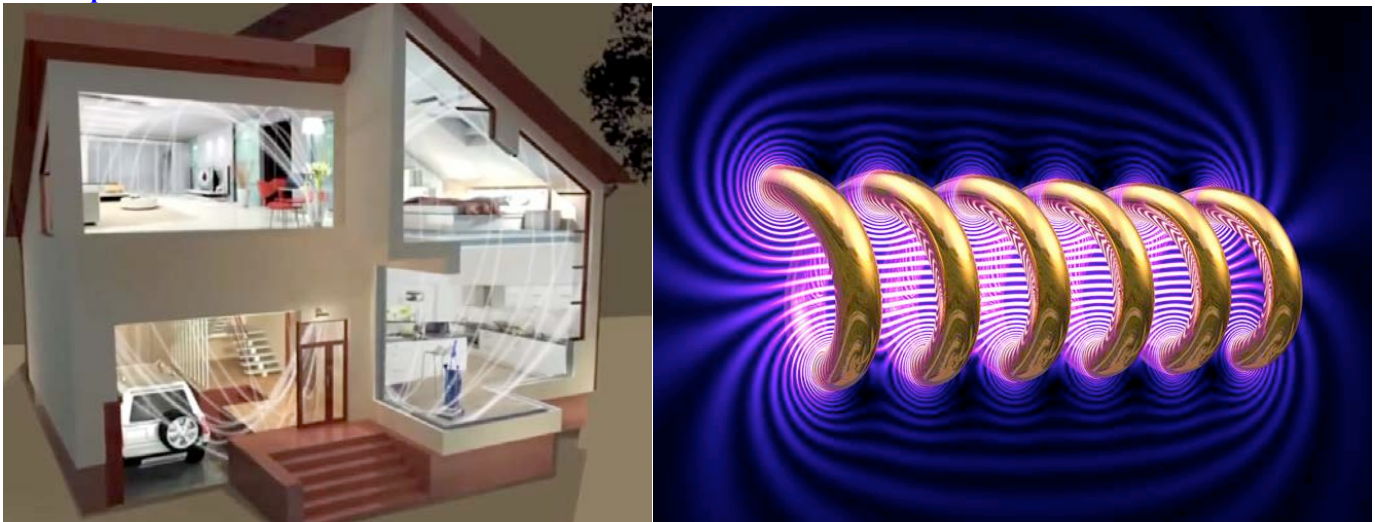

The 'electron microscope' lie

There are no negatively "charged" particles in this universe. Negative electricity discharges while positive electricity charges. The negative depolarizing force functions in the opposite manner and direction to the positive polarizing force. – W. Russell

"Always question the academic who tells you he's manipulating particles that nobody has never witnessed. Countless particles are created in the Atomistic religion of quantum as demonstrable redesignations of electrical and magnetic effects and fields. An entire academic pantheon of liars is established to perpetrate this nonsense." – Author

"Because the SEM (scanning electron microscope) utilizes vacuum conditions and uses 'electrons' to form an image, special preparations must be applied to the sample. All water must be removed from the samples because the water would vaporize in the vacuum. All metals are conductive and require no preparation before being used. All non-metals need to be made conductive by covering the sample with a thin layer of conductive material. This is done by using a device called a "sputter coater". The sputter coater uses an electric field and argon gas. The sample is placed in a small chamber that is at a vacuum. Argon gas and an electric field cause an 'electron' to be removed from the argon, making the atoms positively charged. The argon ions then become attracted to a negatively charged gold foil. The argon ions knock gold atoms from the surface of the gold foil. These gold atoms fall and settle onto the surface of the sample producing a thin gold coating"

Only conductive (metal) samples are suitable for "electron" microscopy untreated, all other samples are metal treated to prevent them from burning up in the intense dielectric beam. The resulting image is therefore of the metal coating or stain and not the original sample! Never believe a relativist telling you he's "shooting his electron gun". A metal dielectric reflector of a once living organism is not the original sample nor are there electrons scanning it. This device in reality is a dielectric scanning reflector, which produces fine images as only reflected off metal surfaces. The very focusing beams of these microscope are constrictor "lenses" of dielectric flux lines.

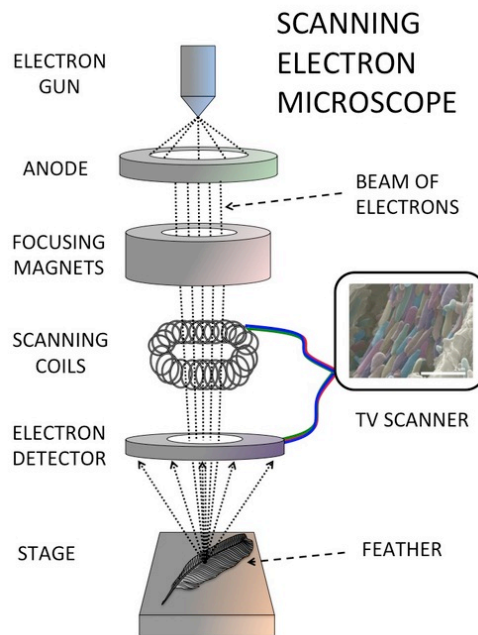

Where is your magnet's polarity, and which side is which? The easy way

Spacetime is the conjugate hybrid interaction of Magnetism and Dielectricity and their mutual transformation into Electric Power and Energy. Frequency gives rise to energy, this in Plancks per second.

This still causes people confusion, for somewhat obvious reasons. See pictures below for details. The quickest way to determine which pole of your magnet, without any field finders or compasses (if you don't have one), is to place the magnet on a smooth glass plate, a diner plate if you wish, add a bit of oil, olive oil, etc. to the plate to reduce any friction, and then lay the magnet on its side with its poles parallel to the ground. If you know the geographic north relative to where you are, whichever direction that is, you must know this fact at least; proceed to gently shake the plate (not up and down!) parallel to the ground, and the magnet will turn its north pole to the geographic north pole of the earth. There you have it, now you have determined your N pole on your magnet (and of course its South pole).

1. The actual north pole of the magnet is defined as the north-GEOGRAPHIC seeking pole, and this is because that is where the **Earth's magnetic SOUTH pole is**.
2. The actual south pole of the magnet is defined as the south-GEOGRAPHIC seeking pole, and this is because that is where the **Earth's magnetic NORTH pole is**.
3. The earth's magnetic NORTH POLE is in the south (geographically), and the earth's magnetic SOUTH POLE is in the north (geographically)

Below: On left as you can see, our compass has its south pointer at the north pole of the magnet, however our field finder, which correct showing "opposites attracting" should be painted in reverse. One could easily get the magnetic polarity wrong by using one of these field finders since the south of the finder is "pointing at this end, therefore that is the south pole". Which would be wrong, it would be the inverse. Such field finders should all be painted opposite so as to avoid confusion. On right we see that (currently!) the Earth's magnetic north pole is in the geographic southern location.

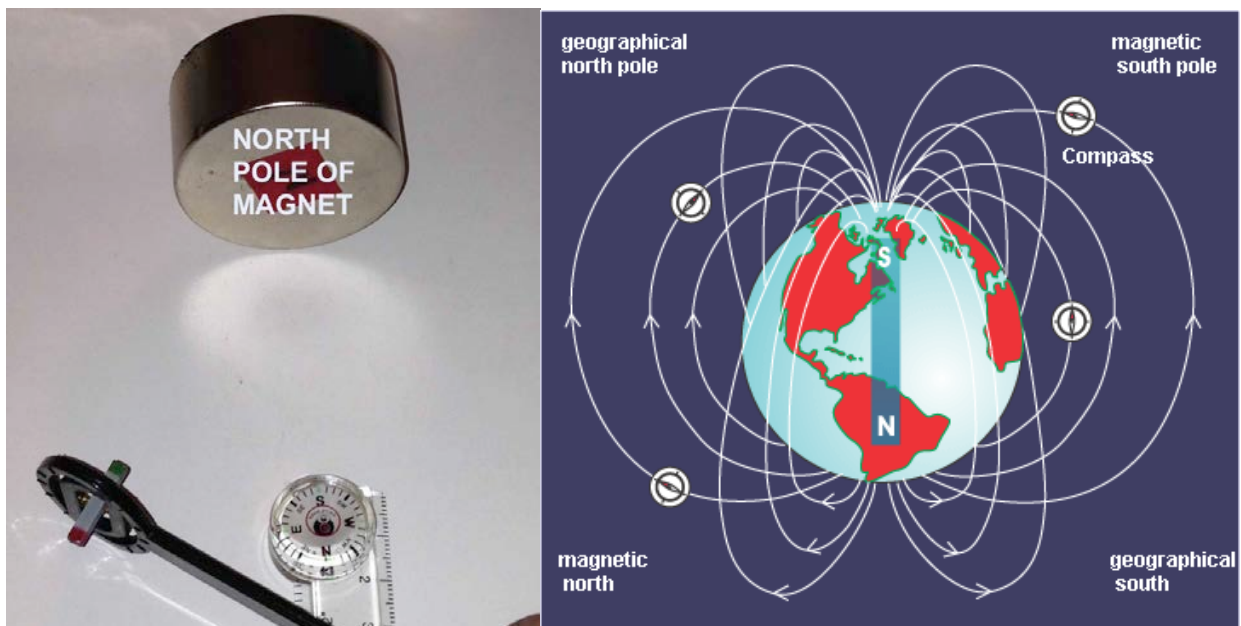

Ferrofluid

*Unlike magnetism the energy is forced or compressed inwards rather than outwards. Dielectric lines of force push inward into internal space and along axis, rather than pushed outward broadside to axis as in the magnetic field. **Because the lines are mutually repellent** certain amounts of broadside or transverse motion can be expected but the phenomena is basically longitudinal. This gives rise to an interesting paradox that will be noticed with capacity. This is that the smaller the space bounded by the conducting structure the more energy that can be stored. This is the exact opposite of magnetism. – Eric P. Dollard*

Dielectricity is the Ether under torsion and torque at its inertial plane; magnetism is a spatial circular reciprocating vortex, an Etheric 'pair' of fountains and countersinks. Electricity is the dynamic radial or reciprocating polarization of the Ether.

The reason ferrofluid forms cone shaped spikes along any pole is that the raised apexes are the alternating centripetal and centrifugal points of preponderance which raise themselves not as lines but as cones. Nothing in nature moves in lines, rather in spirals. To raise any single portion of the ferrofluid is to create inter-atomic magnetic dilation in the ferrofluid, which approaches in a cone-first vortex, as any plane of centrifugal acceleration is cone-base first, whereas any vortex plane of expulsion from the magnet is apex first.

BELOW: One of my own inventions of a ferrofluid suspension on the left with wholly unique properties and interesting attributes. On right is conventional ferrofluid suspension as found immersed in sugar-saturated (or other) water.

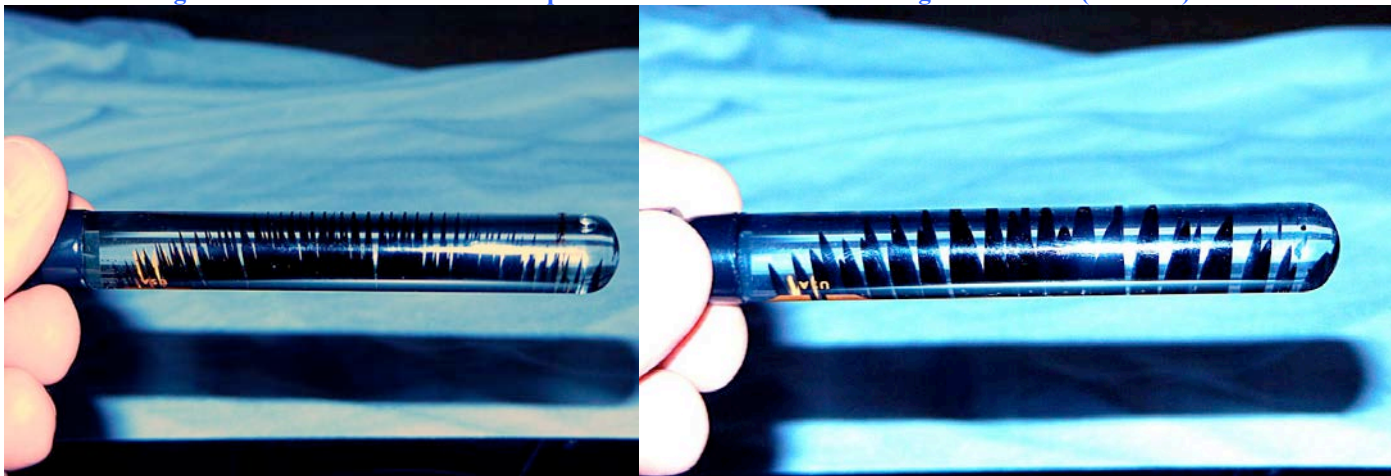

As is the case, any centrifugal vortex is cone-acceleration as highest and any centripetal vortex is apex acceleration as highest. Pressure increases in inverse proportions to the field. As is likewise the case with all fields, the greater the pressure the closer the spatial proximity to field voidance. This concept of the Ether is extremely hard for people to understand. Just as at the center of any magnet, the dielectric inertial plane, there is no magnetism, likewise if one were able to occupy a space at the center of the Earth there would be no gravity, likewise at the axle of any field disturbance there is neither a field nor acceleration. Polarization, and acceleration exist radially from the apex of magnetic field, but inversely accelerate towards the apex centripetally, however regardless of centrifugal or centripetal movement, at the center between both there is neither a field nor acceleration, this is the membrane of all fields in counterspace; in the case of the magnet, this membrane is 'open', and is the dielectric inertial plane.

BELOW: One of my own inventions of a ferrofluid suspension, which give a 25+ second window on the magnetic vortex. Close inspection (now scaled up from this test tube demo) shows a double helical vortex just like a waterspout pictured in the middle.



The apex is always pointing towards the direction of the magnetic flow vortex centrifugally and inversely so centripetally upon intermediate proximity with the ferrofluid (opposite of this in the magnet itself). However since there are two vortexes spiraling in

opposite directions and thru each other, greater forethought is required for accurate visualization. Ferrofluid is magneto-attractive regardless of spin or centripetal or centrifugal movements.

BELOW: Left is a special formulation of ferrofluid immersion, which shows the centripetal vortex of the magnet below it. On the right is standard ferrofluid as explained for the first time ever here.



At the magnetic polar-surface, the ferrofluid apex is always pointing towards the decelerating end of either flow of magnetic vortexes, which is why both centripetal and centrifugal apex points are pointing away from the magnet. High accelerations exist at the surface-mass returning (centripetal) and high accelerations exist at the surface-mass leaving (centrifugal) define both centripetal and centrifugal vortexes.

Centripetal magnetic vortexes accelerate approaching the surface (and deeper) and centrifugal vortexes likewise decelerate from the surface which is their point of maximum velocity.

BELOW: Typical ferrofluid resting against the dielectric inertial plane of a very large 6" by 2" neodymium "magnet". This position causes divergence of the nano-iron particles away from the dielectric dominant inertial plane which is only attractive to itself in dominance.



The reason ferrofluid forms larger cone shaped spikes further from the polarized surfaces is due to the Ether field lines of magnetic divergence undergoing rapid deceleration away from the geometric plane of both convergent and divergent polarized fields. These spikes can be seen regardless of gravity and are not due to fluidic surface tensions of the ferrofluid. The CW and CCW spin vortexes weave thru the ferrofluid creating a field of evenly shapes cones. Small cones indicates high acceleration and large cones indicates increasing deceleration. As is necessitated magnetic strength and velocity (one and the same) can be determined by conical volumes over distance.

BELOW: Ferrofluid spikes, understood correctly here as following golden ratio spirals and the golden angle of 137.5077 degrees

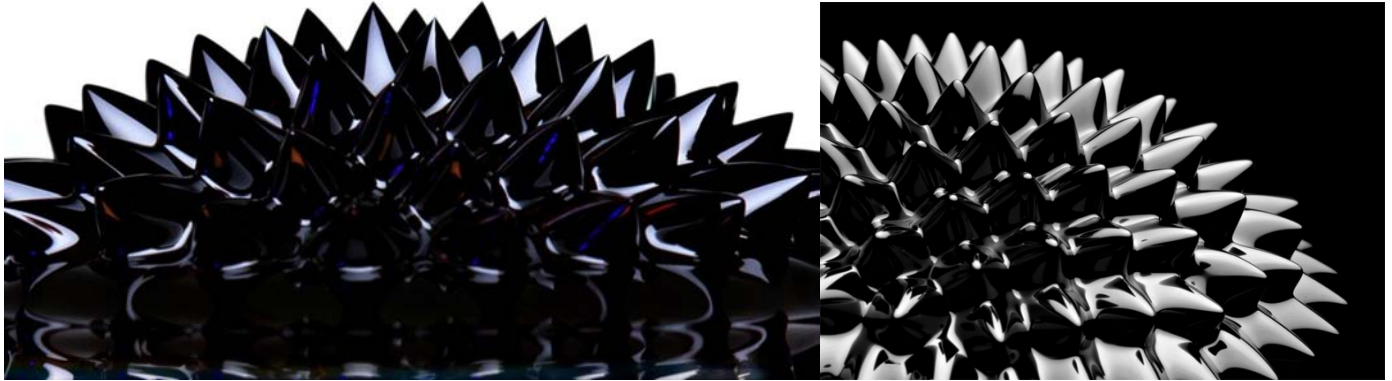

Using a circular container with a small amount of ferrofluid it will be observed that a magnet approaching the ferrofluid will throw the ferrofluid to the outer perimeter of the beaker as if centrifugally dispersed, which is due to the centrifugal expulsion of either outer edges of a magnet which is carrying the ferrofluid in the same centrifugal direction.

Using a circular container with a small amount of ferrofluid it will be observed that a magnet approaching the ferrofluid will throw the ferrofluid to the outer perimeter and likewise create in the very center, at a specific point in approach, a large spike in the center which juts out abruptly like a tongue being poked out of a ringed mouth of outwardly thrown ferrofluid. However upon approaching closer this center spike will split in two, then three and four forming a negative sink 'void' where the highly accelerated returning centripetal vortex is entering at the very center of the magnetic face.

Below: One of my ferrofluid inventions/ suspensions with one of the poles above causing dielectric coherency in the ferrous particles and resultant acceleration to the pole-face. This is dielectric induction coherency. What is reaching out across space (of a field) is obviously magnetism, however magnetism is the cause of the acceleration, rather inductive polarization by means of dielectric coherency.



Below: One of my ferrofluid inventions/ suspensions with the poles laying flat left to right, exposing the dielectric inertial plane to the ferrofluid in my special suspension. Notice that polarization exists in the ferrofluid by induction of either or both poles of the “magnet” and the ferrofluid will accelerate to either pole but not along the dielectric inertial plane. There is no such thing as magnetic attraction; induced iron, or a steel ball will not approach the dielectric inertial plane at close approach since the induced iron, or ferrofluid is magnetically dominant. Magnetism and dielectricity are mutually repellant. All induced objects are magnetically induced and have no increase in dielectric capacitance, only dielectric coherency, likewise they a smaller dielectric footprint than normal.



With much experimentation I was able to create a blend of suspended ferrofluid that would bead rather than clump and demonstrated the center impelling centripetal vortex at the center of any magnet (see picture above).

Below: Left, a centripetal vortex with max spin at its apex (point), as one would see in a pulled drainage plug or a tornado. Right, a centrifugal vortex, where max spin is at the top, or cone of the vortex. This is a magnetic stirrer being stirred by a magnet. This is the first phase of magnetic expulsion, where the magnet in this stirrer plays the analogy of the dielectric inertial plane ‘throwing out’ magnetism along the beaker inner-wall, or magnet-mass-wall, at which, given MORE velocity, the ‘water’ or Ether of the magnetism will be flung out along the top edge of the beaker exactly like in the example of a standard magnet. A centrifugal vortex starts out slow then accelerates towards its cone. A centripetal vortex starts out slow at its cone and accelerates towards its apex. A type of example of a centrifugal ‘vortex’ would be cracking a whip where a minor speed hand motion translates into the end of a whip going so fast as to break the sound barrier.



Regarding magnetic viewing film

At the pole, there is a bright spot in the center because of the centripetal returning magnetic vortex

This film is much more greatly influenced by field velocity than does it accurately show the field, in which case iron filings, in their weak and inaccurate ability to show the field, demonstrate this better than does magnetic viewing film.

Below: Magnetic viewing film left without the film, right, behind the film (red outlines the magnet edge). This shows the high-speed dielectric inertial plane of all magnets. This type of film doesn't show magnetic fields much at all, rather it only reacts to strong field velocities, namely at the inertial plane and along the centrifugal polarized edges of both sides of the magnet where velocity is very high.

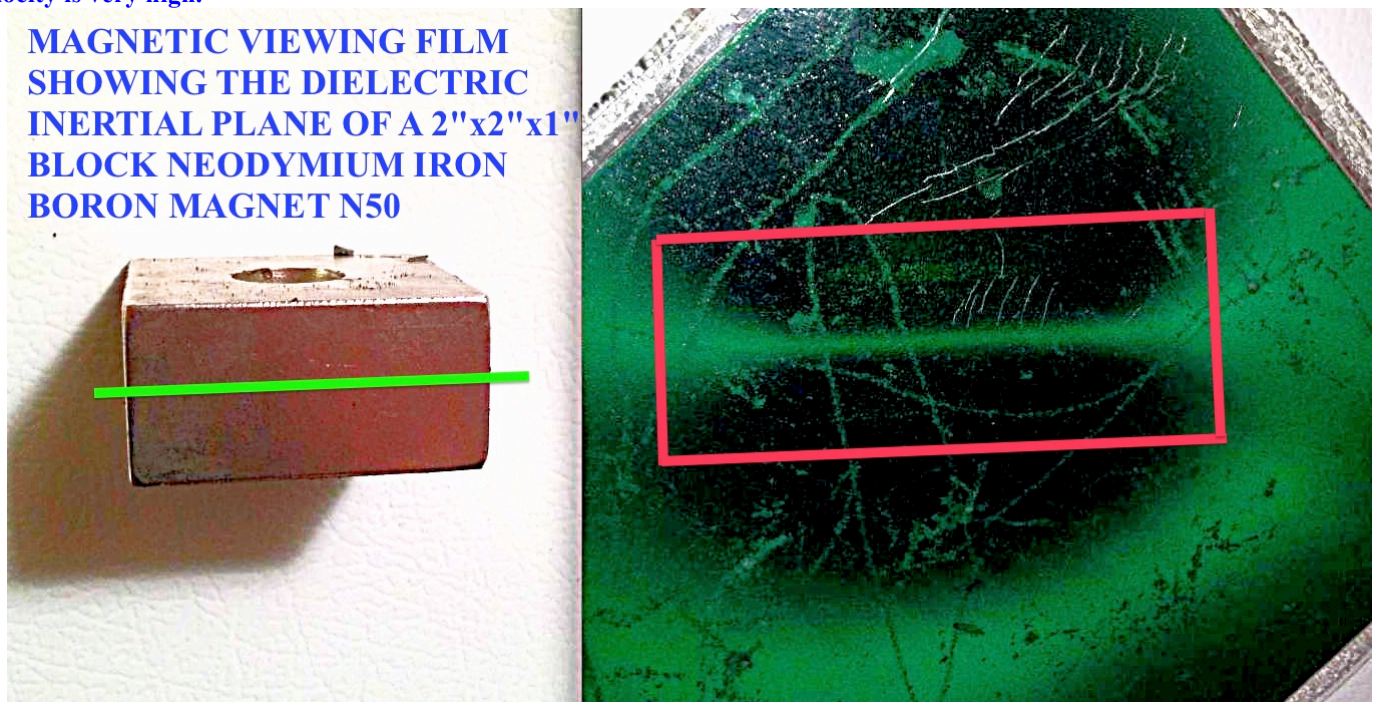

This is not the model of magnetism. The iron filings grand error

“This whole time, humanity has been looking at and fascinated with the wrong sides of the magnet.” – Author

*“Let me be bold and blunt: there is absolutely no such thing as ‘magnetic attraction’ or magnetism-powered ‘ferrous acceleration’ to a so-called ‘magnet’. **It does not exist, nor is there one iota of any validation for this age-old insane premise.** Both so-called acceleration and repulsion are drive by dielectric voidance or counter-voidance (spatial barrier). Not only is there absolutely no such thing as magnetic attraction, I will present you with enormous evidence to the contrary, that ‘magnets’ are wholly powered by coherent dielectrics, with resultant magnetic radiation in discharge as necessitated byproduct. Radiation never attracts anything, only displaces and is the conjugate to dielectricity at the inter-atomic level.” -Author*

The reason iron dust doesn't give an accurate model of a magnetic field is that the iron filings are deep 'in the water' of the breaking waves of the magnetic field, as such they show the direction of the magnetic flow, but not its spiral, its vortex nature, which hydrogen bubbles and pyrolytic graphite (and other mediums) can and do show, since they 'ride the topmost part of the waves' of the vortex magnetic flow. Logically so the iron filings cannot vortex since they themselves become miniature magnets by being magnetically induced, and are locked in place by becoming themselves polarized. Logically but counter intuitively on the surface, any 3D models of magnetism using iron filings are in fact 2D false representations that cannot demonstrate magnetic field architecture

The entire time we have been using iron filings to model the field architecture of magnets has been completely wrong. You cannot model field architecture by any substance that can be magnetized. Doing so creates thousands of tiny dust sized magnets themselves locked into the 2D pressures of the magnetic field geometry, as such this is no indication whatsoever as to the 3D-spatial-counterspatial magnetic vortex architecture of a magnet or magnetism itself. In which case diamagnetic materials must be used. Field displacement gradients with ferrous 'field demonstrators' show polarized direction, but does not show 3D-spatial-counterspatial field architectures. Superficially one may consider that suspending a magnet in the air and throwing iron filings at the magnet will, empirically produce a genuine 3D model of magnetism, as many people have seen demonstrated, however the field geometries of magnetism necessitates that to actually see magnetic field flow, that any material that can be magnetized itself, cannot demonstrate magnetisms' 3D-spatial-counterspatial nature, nor can it demonstrate its flow at all.

A diamagnetic material that acts within time and not frozen in a spatial vector is required to witness the true nature of magnetisms' field architecture. The fact that a field is a non-local attribution not autonomous from the object to which it encapsulates makes it hard for the linear minds of people to conceive of a necessary diamagnetic material to witness a spatial counterspatial field reciprocating spirally and in pressure gradients which has no phenomenal quantity. A snapshot of a tornado is just a hyperbola of wind with phenomena acting oddly outside of this hyperbola. This is the nature and error of using iron dust to model magnetic fields; it is extremely inaccurate at best.

Below: Iron dust models of 2D false “magnetic fields” used by all colleges, textbooks, training tools. These types of field models are critically inaccurate to demonstrate the true model of a magnetic field.

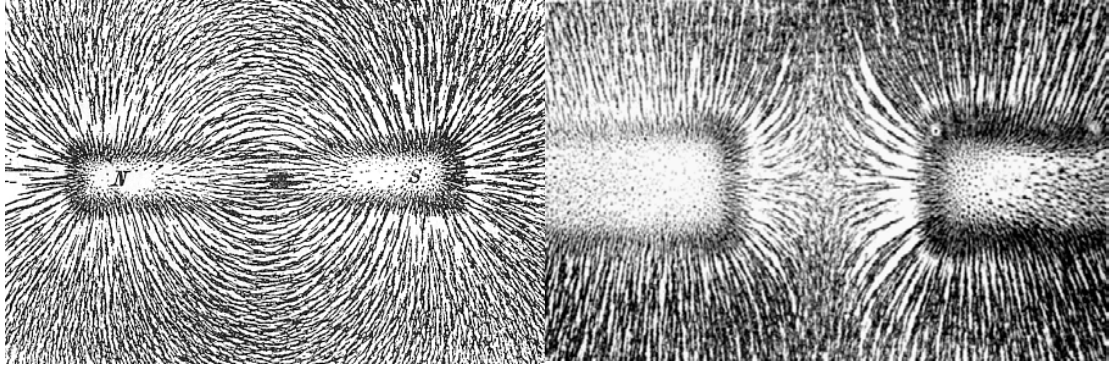

Magnetic Fields. Rational descriptions vs. irrational reifications

Below headline example: Articles created by many different authors in various titles and formats over the years

Three Words That Could Overthrow Physics: “What Is Magnetism?”

The standard model still doesn't describe magnets' spooky action at a distance.

“When this is present, that is present. When this is not present, neither is that.” –ancient saying

“All fields, dielectric, gravitational, magnetic, electrical, are modalities of the Ether without exception. Any conception of action at a distance without an Ether field as mediator is illogical, senseless, and impossible.” – Author

“The quickest way to frighten anyone in GR or QM is to ask them how a field functions.” - Author

“The single greatest fear you can instill in any relativist or materialists is to ask them to define a field, gravitational, magnetic, dielectric, or electric. The thousand pound gorilla in the room of relativity is that action action-reactions and atomic operations are mediated by and thru a field which no relativist can or dare define. All fields are Ether.” - Author

“It is inconceivable that inanimate Matter should, without the mediation of something else, which is not material, operate upon, and affect other matter without mutual contact. Gravity should be innate, inherent and essential to matter, so that one body may act upon another at a distance thru a vacuum, without the mediation of any thing else, by and through which their action and course may be conveyed from one to another, is to me so great an absurdity that I believe no man who has in philosophical matters a competent faculty of thinking can ever fall into (for) it. Gravity must be caused by an agent acting constantly according to certain laws; but whether this agent be material or immaterial, I have left to the consideration of my readers.” - Sir Isaac Newton, Letters to Bentley, 1692

Before embarking on explaining magnetism, first the all important word field must be rigorously and scientifically defined with ambiguity and misconceptions fully removed. A field (Greek: $\chi\acute{o}\rho\alpha$) is a conjugate nonspatial attribute between the subject, Ether, and the object causing the perturbation (or EM induction), either as gravity, electricity, magnetism, or electromagnetism. A field has relevance only as a relational perturbation between the subject and the object causing its appearance; a field is specified only as regards to: electricity, magnetism, gravity, matter, and dielectricity (and another unmentioned for another article); however as it must be necessitated electricity, dielectricity, gravity, and magnetism are by their very principle not different from the Ether itself. The very term ‘magnet’ merely denotes the electrified mass formerly ‘not-a-magnet’; as such magnetism and magnet are abstractions or distinctions without a difference except as relates to the coherent field charges of the before and after mass. Conceptual disambiguation between a magnet and magnetism itself cannot be enjoined, and is merely a fallacious reification of connotative abstractions.

A field as purely an attribute (coordinate to X, or as induced by X) is meant as appearing in time but not in space (otherwise we cannot mark it, even if same is not in time) relationally to the object or that which caused the induction of which the field is a dynamic byproduct thereof; ultimately a field is always the subject (but in ignorance inversely seen as the attribute of another), though appearing posterior to the object which induced it to appear. As stated, there is no Ether in space, only space within the Ether (when polarized obviously), consubstantial reification choate of a field to and with space is a fallacy, when there is the appearance of one “in

space” is as meant there is “space at the appearance of a field”, and incorrectly projected in error as ‘between fields’ additionally. A field, being nonspatial and atemporal (however its affects are both co-principles of any phenomena involving or the byproduct of a field) cannot be ‘after’ anymore than it can be ‘before’ the object of consubstantial reference, which induced it to appear. Just like the field beneath ones feet, the field is before and after, distinctions only being made marking a field when induction is or having had occurred. However unlike the spatial field beneath ones feet which is dimensional, the Ether field is counterspatial and is not, as against the idiocy of GR, conjugate TO, OF, or AS space-time’s conceptual displacement abstractions and fallacious Atomistic reifications of space as a ‘thing’ in place of the Ether which mediates action at a distance, which is impossible.

A ‘field’ is the conceptual and mediated abstraction wrongly reified as an autonomous entity when in fact all fields are as relates to and of the Ether and an object that induces its appearance of which that object is necessarily of course comprised of stable dielectric Ether fields (matter), by logical necessity. A field is strictly a relational attribute and perturbation so noted when induced to appear by an object, by the movement of an object, or abstractly in reference to electromagnetism which is merely a lexical nuance of referring to the Ether itself. To reify a field in itself and in standalone cannot be scientifically enjoined; but for the sake of electromagnetism, the field or Ether are all one and the very same thing in denotation, a pure massless induction, circular, radial, polarized, centripetal or centrifugal, however the induction that led to the creation of electromagnetism (with its dielectric coaxial component) must be introduced as is necessarily the case. It must always be asked “a field OF what (as induced) BY what”. The field, the medium (Tesla’s “supreme medium”), or Ether occupies space as a gradient when induced, but cannot be space itself, nor can a field be comprised of points or lines as commonly understood a “magnetic field”, since magnetism is a pressure gradient of the Ether which dismisses the need for points or lines, since there are none involving same. In nature, there are no such entities as points or lines, only pressures; one must draw a line to make a point, therefore it is not a point, but a termination of a line, and one cannot make a line, since one must begin at a point (which is yet another line) to draw a line, therefore it is not a line but the (charging) expansion of a point. This additionally and summarily dismisses atomistic point particles; all fields and natures pressures are waves and gradients, spatial and counterspatial, radial or circular, there are no exceptions to this in the charging discharging universe of Ether modalities.

In speaking of or about a field the only conventional distinction made between what is everpresent and the localized field is in speaking conceptually about a field-feature appearing in the featureless nonspatial and atemporal background whose locus is simultaneously everywhere and nowhere. This nonlinear subject without a locus, as pertains the Ether, or its abstraction as ‘field’ is the difficulty of linear minds to understand, grasp, express, and wrongly reify a field as a particle-mediated concept or, as GR has ignorantly done, transfer mediation to unreal attributive abstractions such as space and time, or as spacetime. In doing so, the connotative ramifications of the background fabric of the Ether has been circumvented and transferred to an irrational reification of space and time which cannot mediate either charges, magnetism, gravity, or instantaneous action at a distance. Fields operate thru the space within them via pressures, motions and time with no “concern” for same. Space operates on nothing, however it is reified in fields, but only when fields are polarized, and therefore have dimensional vectors which are measured in time and space; but again space does nothing, acts on nothing, mediates nothing, even the Greek Platonists and Pythagoreans knew this ages ago.

Like the fields or lands one stands upon, the field’s potential is ever present but unknown until there is a perturbation, induction, or disturbance in which case the field is readily manifest as pertains its conditional manifestations as phenomena or actions upon other masses. Space is not a field and fails the scientific definition of either subject or object. In the case of the field analogy the Ether can manifest a sinkhole, a hill, or a striation, respectively centripetal gravity (‘sink’), induced electricity (‘uphill’/ generative) or magnetism (‘downhill’ /radiative) around or of an object, or dielectro-electromagnetism itself in waveforms (‘striations’). Gravity itself is, unlike T.E.M. a “positive terminal” circular centripetal-emanative field with a negative Ether-pressure (true vacuum) gradient whose “negative terminal” is in counterspace (Ether). No field can terminate in space, including a gravity field.

Magnetic and electric fields are one in the same thing. In fact, there are no such things as “electrical fields” vs. “magnetic fields” vs. “gravity fields”; they are all just preturbative pressure modalities of the Ether. Likewise, there are no “electrically charged” discharge-particles: only permanent and equalized stable pressures of motion in the Ether; there is nothing outside the Ether, only that which is not inducing the Ether to the macro-world of observable phenomena (of which all phenomena are either Ether based or impelled by Ether gradients). There is no magnetism IN or OF a mass so deemed a ‘magnet’ as implied a field in same, rather what is coincidentally made to appear of/as space (not in space) as the medium to the spatial magnetic mass. There are micro-magnetic forces, obviously so, within all matter, electrified in the creation of a magnet or not, however this is not to what we are directing the article here regarding, yet.

A field must be purely a dynamic concept with either its terminus upon an object of gravity or magnetism or upon itself as in the case of radiated T.E.M., as implied the Ether to which field and Ether are synonymous, either way a field of any type never terminates in space, nor could it, there is space in the Ether field, but no Ether in space, likewise Ether logically therefore cannot terminate in space, as Maxwell, Tesla and others understood well. While the modalities of interaction and nature between magnetism, gravity and electromagnetism are apparently (superficially so) different, all are quantitatively fields by definition and Ether in subject, or principle without exception. Field is a conjugate definition of the Ether regarding 1. Dielectricity 2. Magnetism 3. Gravity 4. Electromagnetic and a fifth one to be named in another work, all five of which are modalities of dynamic Ether motions and pressures; reductively however all are merely nuanced distinctions of the Ether as incorrectly rationalized as different due to waves, geometry, and motions either centripetally, circularly or centrifugally of space. Since the many modalities of fields exist radially, circulator, spatially, counterspatially, centrifugally, and centripetally; herein lies the conceptual nuance in differentiating modalities of the same subject in a field, as relates to and of the Ether itself.

Since a field is always as pertains the Ether, its confused usage and contextual contradictory reference is commonplace, as would be likewise in the case of any non-physical concept without a locus that is or has been reified objectively. A field (all Ether) is not a concept, not a physical medium (of course all physical medium are Ether in principle, as the terminus of dielectricity), not an abstraction, but the subject itself, the medium itself and often only qualified in instances to which it is induced or brought into

dynamic macro-effective perturbations that cannot be ignored. That all fields are sourced in counterspace yet have spatial variants and without a definite locus other than pressure gradients when amplified or induced is not in question. There are no particles used in mediating a field, that is strictly the realm of GR and quantum absurdities that fail on rational, logical and mathematical levels, additionally always on the experimental level. While used casually everywhere in pseudo-science, any attempt by academia to rationally define a field is non-existent, and the highly typical habit of conjugating a field with space or as space is both illogical and wholly unjustified; is purely an ignorant remnant from GR as parroted thru unscientific quantum, of which both are mutually incompatible.

The conundrum of their misunderstandings, in part, is that fields are mass-free (though gravity is sourced in mass, its field is mass-free), particle-free (of any variety), are not physical objects or subjects, however it is evidently and abundantly clear they have physical effects without end; this of course is the very definition of Tesla's 'medium', or Ether. While all fields witnessed in phenomenal influences are archetypes of space, the Ether is not conjugate to, part of, dependent upon or relational to space, nor is there Ether in space, rather space as a polarized dimensional measure of fields and the masses created by same. Space is only relational to masses and magnitudes and the distances between them. To conceptualize a field as a region can only pertain to a perturbation of the field as witnessed from phenomenal effects by same upon other bodies or as a region consubstantial to TEM. Einstein and his disciples argue that fields and space are equivalent. What meaning would space have in a universe devoid of matter? Whether gravitational, magnetic, or electric, we need 'masses' or 'charges' to talk about a field. This argument summarily debunks Einstein's irrational proposal that field and space are synonyms. Einstein was extremely weak on logic in all of his proposals. He was not a very intelligent or rational individual; he was a mediocre mathematician, not a scientist. Magnets do not generate attraction and repulsion by throwing particle showers collectively called 'field' at each other as proposed by QM. All fields are radial or polarized, or circular, and either spatial or counterspatial depending upon their movements, instantaneous action at a distance is mediated between any two objects connected by a pressure gradient of the Ether in the field(s) of influence, including compounded fields.

Circular illogical statements made by and thru mathematical 'science' cannot be enjoined: "field: a region of space... region: a portion of space...space: the infinite extension of field". To employ space to define a field or field to prop up or define space or be synonymous with space are all wrong, logically, and demonstrably. A field can never terminate in space nor is a field even part of space itself, rather is a dimensional measure of a field or fields, of counterspace, and used contextually as an explicit reference of influences of or by empirical objects as mediated thru or from a field. ***Some have, out of desperation to their materialistic mentalities conceded defeat: "A field is an enigma, a question mark. A question cannot serve as an answer in Physics"***. Einstein himself said that so far as his general relativity is concerned, "space (actually spacetime) and the gravitational field are the same things", this type of 'thinking' is pure idiocy of the highest order.

A region is not equivalent to the thing occupying the region itself. Insanity provides that a field, the mediator, occupies space (which it does not, counterspace cannot 'occupy space', there is no counterspace IN space!) or a field is in space, which again it is not; space is within a polarized field or fields or rationalized between fields (rather reified) but the Ether is counterspace, and likewise **cannot be IN SPACE**, rather space is within the Ether when manifest in phenomena or polarized. Einstein claims that a gravitational field is space: "*There can be no space nor any part of space without gravitational potentials; for these confer upon space its metrical qualities, without which it cannot be imagined at all. The existence of the gravitational field is inseparably bound up with the existence of space.*" This circular conceptual reification is a logical fallacy, space has never, and never will be shown to influence anything, nor are space and field interchangeable whatsoever. Einstein was a mental midget for this declaration. If it were, as Einstein insanely states, that a gravitational field = space and the gravitational gradient drops as we move away from the Earth, what has changed in the constituents of space, nothing is the answer. This is outright insanity for which the world lauds such foolishness.

*"There appears to be in the minds of these (supposed) eminent men, some prejudice, or a priori object against the hypothesis of a medium (the Ether) in which the phenomena of light, electrical actions at a distance take place...the existence of a medium in which light is propagated. But in all these theories (the insane Atomistic ones) the question naturally occurs: If something is transmitted from one particle to another at distance, what is the condition of it after it has left one particle and before it reaches another? If this something is the potential energy of the two particles, as in Neumann's theory, how are we to conceive of this energy existing in a point of space, coinciding with neither one particle nor the other? In fact, whenever energy is transmitted from one body to another in time, **there MUST BE A MEDIUM OR SUBSTANCE IN WHICH THE ENERGY EXISTS** after it leaves one body before it reaches the other, for energy, as Torricelli remarked, is a 'quintessence of so subtle a nature that it cannot be contained in ANY vessel except in the inmost substance of a thing (counterspace/ dielectricity, the Ether)'..." – J.C. Maxwell *Treatise on Electricity and Magnetism vol. II**

Below: Contrary to human conceptualization, as pertains fields rather than empirical objects, increasing movement is decreasing inertia, and decreasing movement is increasing inertia, however this increasing inertia is apparently (only) achieved by increasing movement towards voidance, but said increased movement is the proportionality of the decreasing sphere of space (= motion) between two or more objects. The highest expression of inertia is one in which movement is at maximum resistance, or magnetic reluctivity, as found in bismuth for example. To add to this confusion, in the voidance of increasing inertia there is increasing physical movement which is pressure mediation directed at decreasing movement ultimately. As such we can accurately state that an iron object accelerating towards a “magnet” is decreasing movement in voiding the space between it and the “magnet” thereby decreasing the space, which is movement definitionally. The shrinking spatial sphere between objects undergoing mutual spatial (=movement, polarization) voidance is the elimination of movement. While apparently moving fast in voidance, the shrinking spatial sphere of voidance denotes decreasing movement and spatial voidance. Divergent movement and convergent movement are two wholly different quantities. One indicates increasing inertia, the other decreasing inertia. All divergent motion in creating space is immanently decreasing; all convergent motion in voiding space is immanently increasing motion, but only as an expression of the shrinking spatial sphere between both, and only halts at highest dielectric inertia, or voidance; as such we must state that convergent voidance is the dissipation of all motion by increased motion (which is really spatially elimination) to full voidance of same in eliminating the motional polarization, or space, between the two objects. This motion is as regards the shrinking sphere(s) of space between these objects and said motion is not an attribute of either object in their motions towards increased acceleration and voidance of all motion. The speed of light is only a quantity of the rate of induction as measured in time of either voidance of countervoidance, or as meant the terminal velocity of divergence or convergence of magnitudinal, transverse fields.

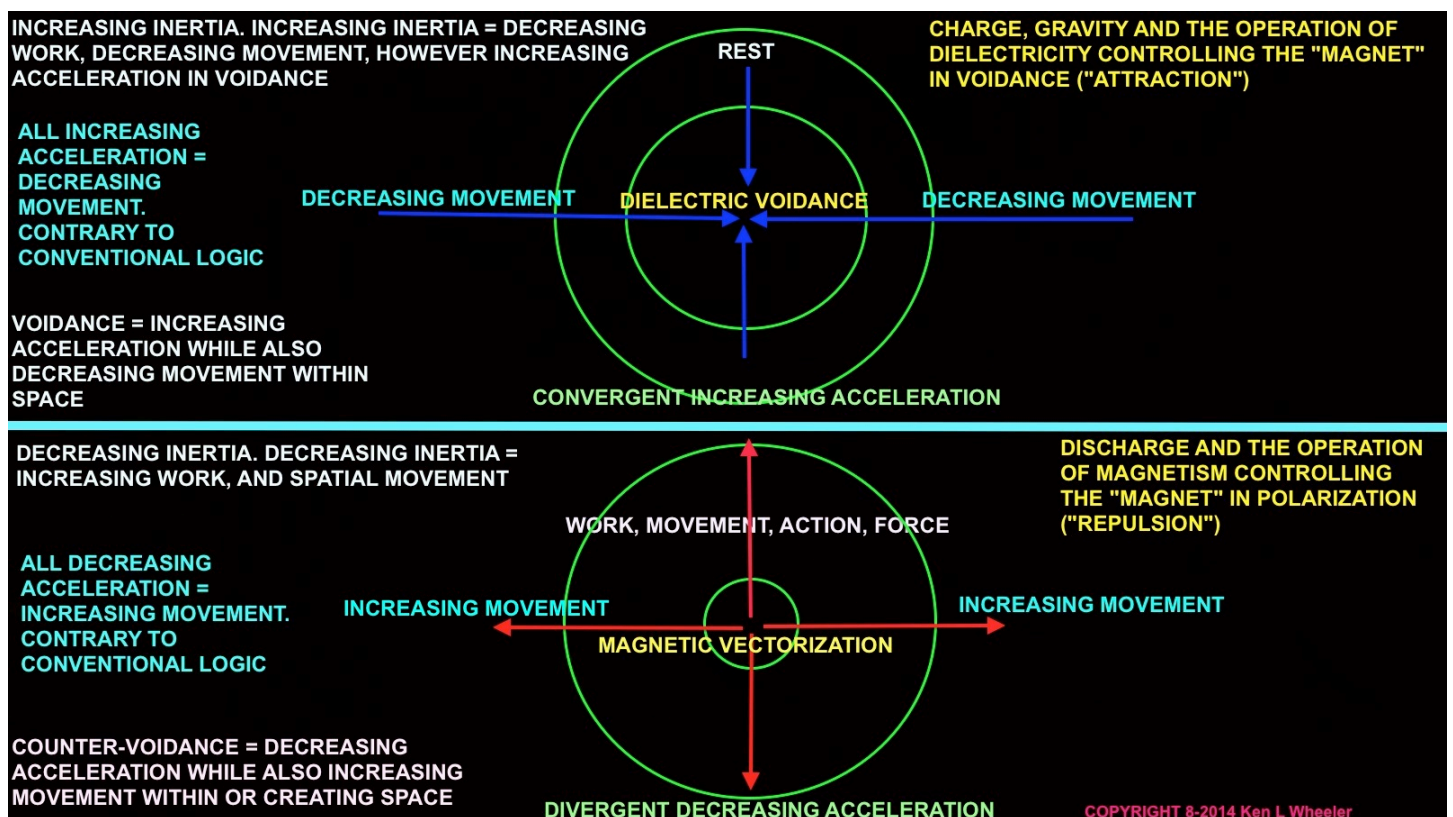

Faraday wondered why, when the distance between two objects is doubled their mutual attraction (voidance) for one another falls off to one-fourth the former. Faraday was highly dubious regarding Newton's conclusions about force. The fact is that the “missing three-fourths of the force” is not lost whatsoever, the loss of mutual acceleration is in counterspace and mediated between both dielectricity and magnetism, both impelled by and ‘lost’ therein; this is a natural attribute to dielectricity, either as found in the so-called “magnet” or in its aggregated form as found in mass/matter. Newton’s equation is not about force, or as argued by others, tension, rather **dielectric voidance**. In which case we have the equation of Newton corrected: $D.V. = M1 \times M2 / \text{Distance}^2$. **All acceleration of bodies via gravity or “magnets” are undergoing dielectric voidance, or magnetic (so-called) induction and resultant acceleration is the simplex process of dielectric voidance.** The presumed increasing or decreasing ‘force’ is merely a field attribute necessitated by which spatial voidance is enacted to mediate the dielectric field voidances which eliminate space in their accelerations towards pressure voidances created by magnetism. Absolute acceleration is zero empirical movement, or perfect Ether inertia.

$F=ma$ is correctly pertaining to “magnetism” and gravity: Voidance = dielectricity as measured in mass x acceleration. As stated, magnetism cannot, has never attracted or accelerated anything, rather only causes dielectric coherency and resultant acceleration by means of dielectricity in voidance. **Both gravity and so-called “magnetic attraction” operate off the principle of shrinking spheres of dielectric voidance in which, as found in the case of both, the decreasing spherical area is proportional to the**

voidance and resulting acceleration. Faradays “missing three-fourths of the force” is not missing, it is and always has been a translational exchange between increasing or decreasing space in which both magnetism and dielectricity mediate field pressures.

Contrary to empirical phenomena and objects which are in motion and are denoted to have ‘inertia’ and likewise its opposite being ‘rest’; the inverse is true of dielectric inertia or the Ether membrane in specific, its termination is movement, is polarization (i.e. magnetism), is work, action. Additionally the fact that the universe is speeding up in acceleration has been declared a mystery by the fools of academia, since this is contrary to their conclusions. However this acceleration is PROOF the universe is decreasing in movement and winding down, just the inverse of their idiotic understanding that the accelerating galaxies are proof of increasing divergence or movement. Just the opposite is the case; this correct measurement of accelerating galaxies is proof of their ‘winding down’ into voidance.

As per the dielectric, the Ether, its innate unperturbed (usually) state, that inertia in termination is movement, work, action, polarization. All inertia discharge is movement, work, polarization, to couple out of that membrane at rest is action, the Ether in loss of inertia must translate into work, action, and the complete opposite of rest. The loss of field inertia is translated into empirical and phenomenal work, if this were not the case, nothing could be powered or run off the feed lines of electrical magneto-dielectric inertia which flows down the lines into your home. As such, contrary to phenomena in motion by which we denotate rest of same phenomena as a loss of inertia, the absolute inverse is the case for fields.

An atomic explosion, of which all matter is still present and not converted (contrary to Einstein and wholly backed by Tesla) there is a loss of inter-atomic inertia. The uranium, plutonium, or tritium are still within the mushroom cloud. All of the original components needed to reconstruct the transformed atoms to their initial nuclear states are speeding away in all directions and could, in principle, be reassembled back into the original nuclei. To reassemble these components would require the same amount of kinetic energy that was released in the explosion. The energy of the explosion comes not from converting matter to energy, but from the kinetic inter-atomic energy released. This energy did not just appear from a transformation of matter into energy as Einstein and his fools have forwarded, but was always contained within the internal motions of the inter-atomic and nucleal dielectric inertia. The only transformation that occurred was the conversion of rotational kinetic energy into linear kinetic energy. An atomic explosion, for example, is nothing more complex than many many trillion tightly wound pocket watches which are near instantly disassembled releasing their stored inertia. All the parts and gears are present after the fact. No matter or ‘gears’ were or are converted into energy. Tesla derided this insane premise of Einstein, and rightly so.

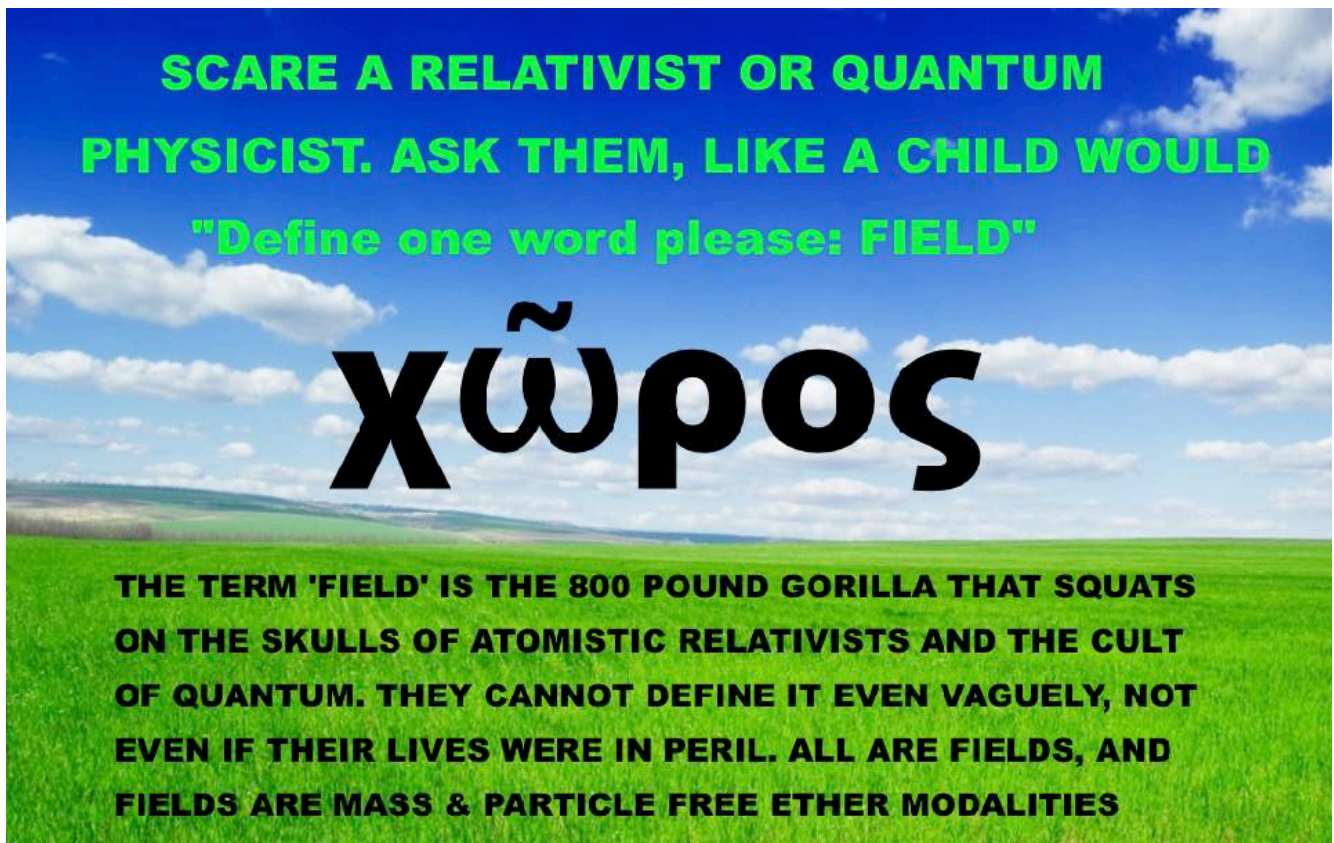

Atomists and relativists quoted in black, the corrections are in blue

Atomist: “We cannot take a snapshot of a field because, on the one hand, a field is not a stand-alone object, and on the other, it is a dynamic concept.”

This is not the case; the field is an arena of influence by Ether pressure gradients. This arena is dynamic and flowing.

Atomist: A field is a physical relation between two objects that compels one or both to move.

This is not the case, a single mass-object in a field has space within that field, that there is not a secondary object under influence of the field has no bearing on the matter.

Atomist: A field is not like the still waters of a swimming pool. A field is better likened to the word wind. You can't take a snap-shot of a field. You can only film it. If you took a picture, it is not of a field. Yet the dynamic notion of field is conceptually at odds with the static notion of region. Either a field is a flowing river or it is a static halo. It can't be both

The Ether itself is the 'still waters' of the pool. A field is likened to "wind" only when two objects are interacting, either by gravity, or induction, or charge-discharge. A field is immaterial, is not mediated by particles, as such there is no 'picture of a field', yet their influences are well known by all. There is no "at odds" with a field, what something is in principle, or subject, so it is in activity, influence, induction, gravitation, electrification, or polarized magnetism. A "snapshot" of a magnetic field, or a single line of it specifically is a halo, however that magnetism reciprocates like a flowing river, centripetally and centrifugally can be denied by none.

Relativist, mathematical explanation nonsense: "Field: the space around a radiating body within which its electromagnetic oscillations can exert force on another similar body not in contact with it"

Conceptual reification fallacy, a field is not space, nor inversely so. Space operates on nothing. There is space within any field, as necessitated by its polarization, but there is no field in space, as being implied 'another medium'. Space is a dimensional abstraction.

Relativist, mathematical explanation nonsense: "Field: a mathematical entity which can be thought of as a collection of numbers"

Conceptual reification fallacy of a field as a numerical abstraction.

Relativist, mathematical explanation nonsense: "Field is a physics term for a region that is under the influence of some force that can act on matter within that region."

Conceptual reification fallacy of a region as = field. A field influence is pressure gradient based, centripetal, centrifugal, polarized, or radial.

Relativist, mathematical explanation nonsense: "Every magnet produces an invisible area of influence around itself... Scientists call these invisible influences fields. You can make magnetic fields visible to the eye by using iron chips sprinkled on a piece of paper with a magnet underneath."

Using iron dust to show a snapshot of a field line is not making a field visible, only its attributional influences visible.

Relativist, mathematical explanation nonsense: "Two kinds of physical objects must coexist: particles...and fields."

Fields are not physical objects, of this, it is abundantly clear from endless experimentation.

Relativist, mathematical explanation nonsense: "Field: a region of space... region: a portion of space...space: the infinite extension of field"

This is circular, fallacious, and highly illogical.

Tesla against Einstein and for the Ether

"This medium of propagation, the Ether must exist. This medium must be a prominent thought in our investigations." **Treatise on Electricity and Magnetism – J.C. Maxwell**

"According to the General Theory of Relativity (pure bunk), space without Ether is unthinkable." - **A. Einstein**

"The word Ether has extremely negative connotations in theoretical physics only because its past association with opposition to relativity. This is unfortunate because stripped of these connotations, it nicely captures the way most physicists actually think about the vacuum. The modern concept of vacuum space confirmed by every experiment is a relativistic Ether. But we do not call it this because Ether is a taboo term." - **Robert B. Laughlin**

"Einstein and his ilk reified space as 'something' that 'did things' and 'acted upon things'. This is the fallacy of attribute reification, and is a titanic error of thought and theory. Einstein has blamed the flies (forces) on the horse feces (space), completely ignoring the horse (fields) entirely. This brain wasting idiocy can and must come to an end given time and intelligent minds to see clearly. Nobody who has ever lived has seen space 'do' anything." -**Author**

"Nothing is "shot" out of the moving laser. The electric field can only 'soak into the medium' at the rate defined by that medium. Light can only travel at luminal velocity as defined by the dielectric medium and its dimensional relation of one over c square, a numeric constant. Light is not a material projection, it is an inductive process, a process of the Ether." -**E. Dollard**

"Mother nature called, she said she never created a 'negative charge', only discharge of a charge. She informs you that if you can produce a 'negative charge' she can produce a pregnant baby and red-hot ice" -**Author**

Most everything you touch every day has its birth with Tesla. Absolutely nothing you use, touch, or need or otherwise has its origins in Einstein's writings or creations, of which there are none. Tesla described relativity as "a beggar wrapped in purple whom ignorant people take for a king." The theory, "he said, "wraps all these errors and fallacies and clothes them in magnificent mathematical garb which fascinates, dazzles and makes people blind to the underlying errors. The theory is like a beggar clothed in purple whom ignorant people take for a king. Its exponents are very brilliant men, but they are metaphysicists rather than scientists. Not a single one of the relativity propositions has been proved." – **N. Tesla**

What is the Ether, or in specific, what do we know of same? The Ether is the inertial plane whose XYZ-axis is at every 'point' in which space can be found within the Ether but not the inverse, but of course this Ether precedes space itself and defines space which is co-relational only to magnitudes (not mass, which is the domain of the Ether) and time. This inertial membrane / plane can be brought into phenomenalization thru magnetic perturbations of the dielectric plane, or likewise in polarization from electrification of a mass

creating an Ether bubble, or portal, likewise gravity and otherwise. Ether can move spatially (rather space moves in the Ether) as polarized (magnetism) centripetally (dielectricity or gravity) or centrifugally, depending on the variety of the field, magnetic, gravitational, electrical, dielectric. What is moving, and the movement itself is the aoristos dyad of the Greeks, Principle and attribute are one and the same entity, as is light and illumination. Will and willing. To speak of the Ether and an Ether bubble or vortex is merely the conceptual bifurcation of one thing, as differentiated in principle (as the Ether), as against itself in attribute (as a vortex, movement, or field-causative), but this differentiation is purely an empirical consciousness based construct.

An extremely important point that must be grasped, otherwise nothing can be understood about anything really, is that Ether only gives rise to Ether. What does this mean? It means that magnetic fields are the resultant movements and terminations of electrical fields, which is another spatial vector of the movement of the Ether, or a dielectric centripetal radial Ether dominance gives rise to macro-magnetic appearances of magnetism, as in the case of a permanent magnet. Dielectric Ether fields in special geometric forms gives rise to the creation of matter which itself is a stable form ("strong nuclear force") of dielectricity, which then has its own field, centripetal gravitational fields. All fields were created, or are the result of the termination of another field of Ether. This extremely important point cannot be lost, or misunderstood, otherwise nothing can be understood.

All humanity currently is focused on efficient ways to transform one type or modality of Ether movement into another type! Falling water (centripetal gravitational Ether field) is forced to pass thru a turbine which forces a polarized magnetic Ether field to cause torque on a dielectric reflector (A dielectric reflector is in reality a dielectric transmission medium [like to like], it is a 'magnetic reflector' such that it can, in electrification, be pulsed and its superluminal dielectric inter-atomic inertial plane torqued as a sweeping magnetic field causes dielectric precessional torsion, which produces electrification), and this copper structure creates electrification, another polarized electrical Ether disturbance to reflect down the lines and thru substations to feed your microwave (electromagnetic Ether field, polarized), or your AC unit or fan, such that you have an electrical field of the Ether dumping out at the 'end of the line' from AC generator to AC motor. Light rays (dielectro-electromagnetic structure, with a radial and coaxial dielectric component) from the sun, these dielectric (Ether field, radial) inductions cause induction in solar cells, and feed other types of field requirements and needs. All humanity is in the business of using or creating (most without knowing it) field manipulations. Nuclear reactions based upon stable dielectric matter-fields which are in unstable atomic geometries which radiate nucleal particles, (radiation being a field function of the Ether). Burning flammable coal, or gas, or oil, part of mass, which itself is a dielectric field unit within the nuclear elemental, the atomic.

Instead of 'conservation of energy', it should be called the 'conservation of the Ether'. However all fields are induced or transferred thru to another by the Ether alone, this means that induction cannot occur where the Ether is not, and likewise it means that (Tesla's discovery) inertia and momentum can be discharged by equilibrium with the Ether by a special means of grounding. Meaning a terawatt of power can vanish with no resultant effect, or that you could create a system where a body could decelerate from 1000 MPH to 0 with no resultant forwards momentum, friction, or inertia. Contrary to popular belief that "energy cannot be destroyed, only transferred" is a myth. This only holds true if induction is possible and natural, energy can indeed be 'lost' completely, as was first discovered in AC generation stations where, before the generators got up to working inertias, enormous power is lost for a short time with no resultant dissipation into our world. Ether is the "ultimate" medium (Tesla often interchanged the term "medium" with "Ether") - being a perfect 'fluid' and transporting independent carriers. Tesla said that electromagnetic radiation was propagated, like sound waves in the Ether. GR and QM, the cult of quantum, has merely displaced the Ether as "dark matter" which according to their (likely incorrect) calculations, comprises almost all the universe. Which means in fact, in their myopic misunderstanding, that the remaining few percent of the Universe are merely bundled Ether fields in stable forms (for a while) as plasma, elements, magnetism, gravity, and likewise. Therefore ultimately, of course, all is the Ether.

"Too bad, Sir Isaac, they dimmed your renown and turned your great science upside down. **Now a long haired crank, Einstein by name**, puts on your high teaching all the blame. (he) Says: matter and force are transmutable and wrong the laws you thought immutable. I am much too ignorant, my son, for grasping (crazy) schemes so finely spun." - **N. Tesla (Fragments of Olympian Gossip. by Nikola Tesla regarding Einstein)**

"Ether is the cause of every magnetic field. Electricity could not exist without the Ether. Ether is the medium for all EM waves from radio to gamma. Every particle in the universe is bathed in a sea of Ether, including the (so-called) electrons of atoms and plasma. Ether is how particles 'know' they are moving near the speed of light in a vacuum, even if they are accelerated very slowly. When the Ether gets cold enough, its properties change causing strange phenomena to both atoms and light. Using very cold temperatures is a way to isolate exactly what the Ether affects; cold temperatures are to Ether physics what accelerators are to particle physics." - **N. Tesla**

Tesla said of theory of relativity: "a mass of error and deceptive ideas violently opposed to the teachings of great men of science of the past and even to common sense." - **N. Tesla**

Tesla stated that there was no energy in matter other than that received from its environment, i.e. the Ether. This is the most suppressed statement from N. Tesla himself: "... *Supposing that the bodies act upon the surrounding space causing curving of the same, it appears to my simple mind that the curved spaces must react on the bodies, and producing the opposite effects, straightening out the curves. Since action and reaction are coexistent, it follows that the supposed curvature of space is entirely impossible – But even if it existed it would not explain the motions of the bodies as observed. Only the existence of a field of force can account for the motions of the bodies as observed, and its assumption dispenses with space curvature. All literature on this subject is futile and destined to oblivion. So are all attempts to explain the workings of the universe without recognizing the existence of the Ether and the indispensable function it plays in the phenomena. My second discovery was of a physical truth of the greatest importance. As I have searched the entire scientific records in more than a half dozen languages for a long time without finding the least anticipation, I consider myself the original discoverer of this truth, which can be expressed by the statement: There is no energy in matter other than that received from the environment.*" - **N. Tesla**

“I hold that space cannot be curved, for the simple reason that **it can have no properties.**” - N. Tesla

“Today’s scientists have substituted mathematics for experiments, and they wander off through equation after equation, and eventually build a structure which has no relation to reality.” - N. Tesla

“In the writings of J. J. Thompson it is found he considered dielectric propagation and magnetic propagation can be independent. Also considered is that **magnetism is a secondary response to dielectric forces.** This is also found in the writings of C. P. Steinmetz, “Transients in Space”, from “Theory and Calculation of Transient Electric Phenomena”. Here is the “Hysteresis of the Ether”, the alternative to the concept of electromagnetic radiation”. -E. Dollard

“When the electric current comes into being, it immediately sets the surrounding Ether into some kind of instantaneous motion, the nature of which has still not been exactly determined. In spite of the continuation of the cause of this motion, namely the electric current, the motion ceases, but the Ether remains in a potential state and produces a magnetic field. That the magnetic field is a potential state [of the Ether] is shown by the [existence of a] permanent magnet, since the principle of conservation of energy excludes the possibility of a state of motion in this case. The motion of the Ether, which is caused by an electric current, will continue until the acting [electro-] motive forces are compensated by the equivalent passive forces which arise from the deformation caused by the motion of the Ether itself.” - (“Concerning the Investigation of the State of Ether in Magnetic Fields” by Albert Einstein)

Counterspace, the Ether

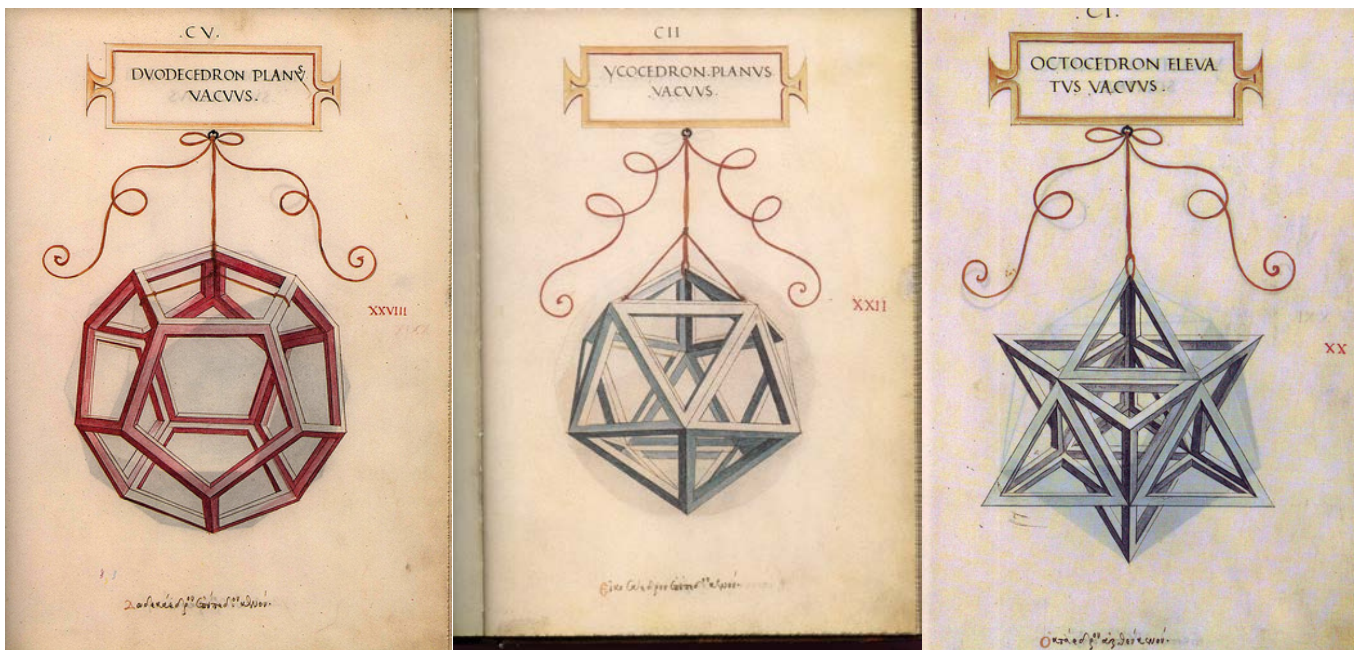

“The day science begins to study non-physical phenomena, it will make more progress in one century than in all the previous centuries of its existence.” – Nikola Tesla (referring to Ether science)

“In order to understand electricity, you have to have an understanding of counterspace, otherwise it’s impossible.” - Eric P. Dollard

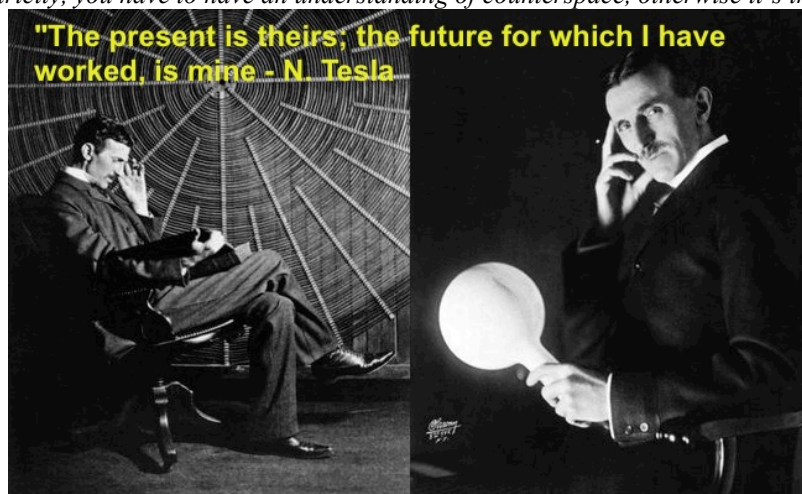

“There is no energy in matter other than that received from its environment (as meant Ether fields).” – Nikola Tesla

“Both dielectric and magnetic fields exert mechanical force upon the bounding system of so-called "conductors." These mechanical forces, those of the dielectric, and those of the magnetic, exert actions so as to increase their coefficients of induction, that is the dielectric "capacitance", and the magnetic "inductance" are increased. Hereby, the dielectric field draws the conductors nearer to each other, increasing the counterspace. Conversely the magnetic field pushes the conductors away from each other, increasing the space. Hereby we may say that the dielectric field is contractive, and the magnetic field is expansive.” – E. Dollard

Below: Field and energy archetypes, the phenomena and their movements

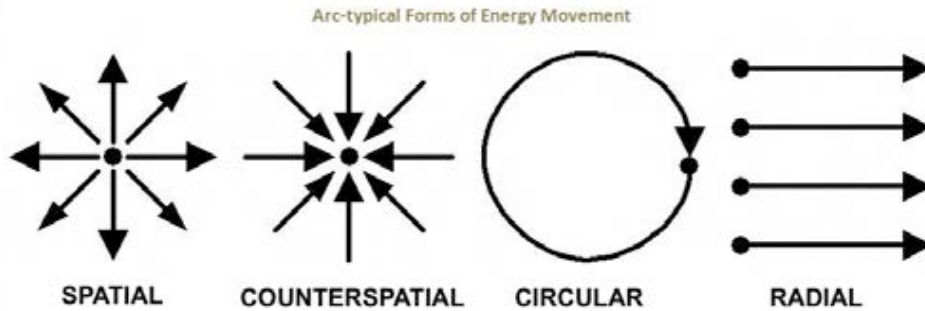

Six Fundamental Types of Waves: First set: TEM (transverse electro magnetic) Waves: 1. TE – Transverse electric (dielectric) 2. TM – Transverse magnetic 3. TEM – Transverse dielectro-electromagnetic with dielectric as the longitudinal coaxial Z-axis.

Second set: Longitudinal waves: 1. LD - Longitudinal dielectric 2. LM - Longitudinal magneto 3. LMD - Longitudinal magneto dielectric.

Electricity is comprised of two components

1. Dielectricity – Generated by a capacitor, counter-space phenomena; storage and return of dielectric energy.

2. Magnetism –Generated by a coil of wire, decaying electricity, spatial phenomena; storage and return of magnetic energy; electro-motor force; lines per second.

Electromagnetic induction – time & magnetism; produces melting; radiation. Dielectric Induction – Brighter light, no melting, higher frequency, less power usage, blue spark, growth and generation.

Electrical Engineering has four primary dimensions

Metric

1) time, t, second

2) space, l, centimeter

Field

3) magnetism, , Weber

4) dielectricity, , Coulomb

Dielectric field = Φ/lxT (Weber per centimeter-second)

Magnetic field = Ψ/lxT (Coulombs per centimeter-second)

Electromagnetic induction: E (volts) = Φ/time

Magneto-dielectric induction: I (Amps) = Ψ/time

Below: From the book ‘De Divina Proportione’ (About the divine proportions [the golden ratio]) by Luca Pacioli 1509. The book was illustrated by Leonardo da Vinci. On the left you can see space, and on the right, counterspace, or inverse-space, or ‘negative-space’. Dielectricity is counterspace. Only two copies exist of this work.

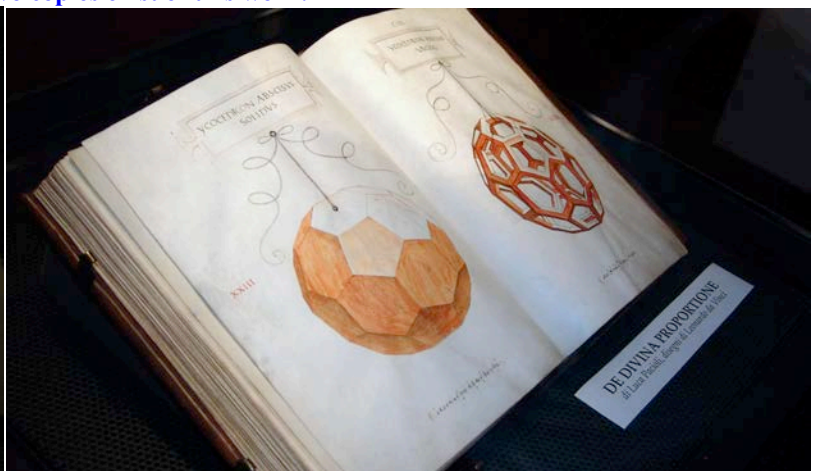
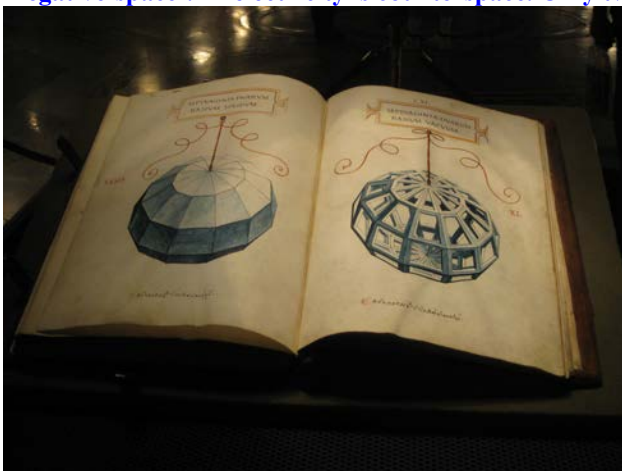

Dielectricity is the Ether boundary, the inertial plane, and the membrane at which only another conjugate polarized field can torque to create other phenomena.

Fundamentally people cannot wrap their minds around the fact that moving a magnetic field against a magnetic reflector which causes electrification is piercing the Ether membrane and is the transference of inertia from a prime mover (water moving the magnet, or wind, nuclear etc.) into the creation of electricity, and via nature's way dielectricity terminating into the creation of matter. There is nothing in the magnet, or in the copper coil which is creating electrification, the magneto-dielectric field geometries of both working together as oppositionally moving co-principle conjugates in and of nature are creating the electrical current. This is why Tesla said that you "cannot get energy out of matter". Counterspace is literally the space between space itself, the very omnipresent membrane of the Ether which requires conjugate field forces to bring it into space or create electrical or dielectric, or magnetic phenomena, or the even the creation of matter.

Below: It is impossible to understand the most fundamental Ether-modality, dielectricity, without a firm grasp of counterspace. It is likewise impossible to understand magneto-dielectric incommensurable field conjugation without a firm grasp of dielectric inertia, which is centripetal, counterspatial, radial, and has no magnitude of its own accord except in divergent discharge, as magnetism; another Ether-modality and co-principle conjugate with dielectricity, together of which both are the two fundamental Ether energy modalities of the universe.

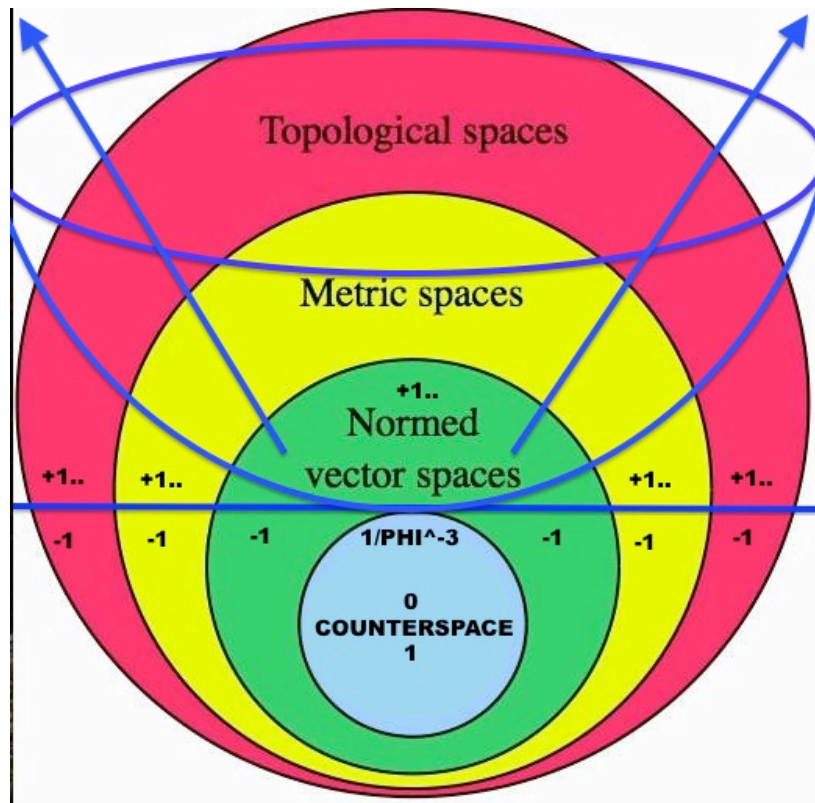

How do you compress or torque something that isn't 'there' (in space)? By fields and by fields alone, which all fields are Ether by nature. Ether induces the Ether, as any one of several different types of fields or phenomena depending on the scenario.

Below: **Manifold space, one counterspace; inertia.** One of the two is a stereographic projection and therefore = 0, but counted as 1 (and more), the other has no spatial definition, and therefore empirically = 0, but ultimately = 1.

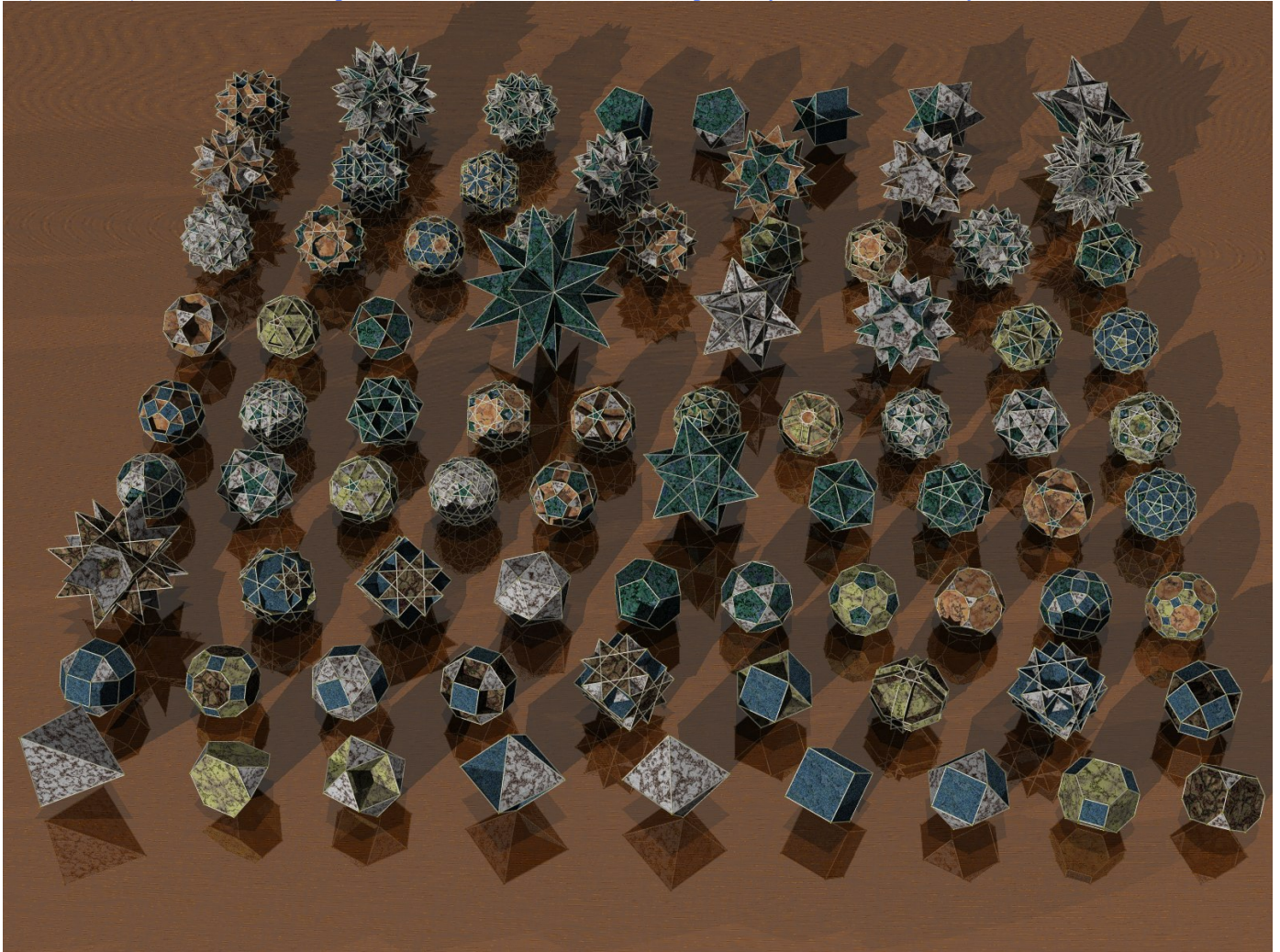

Below: Dielectric radiant discharge



The Ether is always trying to terminate back into counterspace, its origin and fulcrum, it is only by reciprocation, movements and countless other phenomena that it is 'kept' in space (for a short while, but an eternity as measured by the life of any human). In saying 'counterspace' we are talking about the Ether itself, its principle, its domain. Space is the vector of phenomena, counterspace is the fulcrum of phenomena and is the inertial plane, or membrane of the Ether from which all phenomena are manifest in space. Counterspace is the noumenon, which when disturbed, gives rise to phenomena. The question then must be raised, how does the Ether, where there are no fields, produce anything to begin with? The Greeks answered that long ago and the answer is divinely simplex, however left for another article.

Magnetism is purely radiative, is the termination of electrification and the end-of-road byproduct of dielectricity. Dielectricity comes before everything else in the four-part schema of Force Unification. **Dielectricity and magnetism are the two co-principles of the universe.** So how do you get magnetism out of dielectricity, since magnetism requires a subject to emanate from or itself is the termination point of either mass in movement or electricity as it terminates? The answer is that dielectricity terminates into the creation of matter, which itself then has in this conjugate relationship, magnetism as its radiative principle (the proton as found in hydrogen, the most abundant element is magnetically dominant, is the polarized charging dynamo for its discharge plane of interatomic magneto-dielectric volume). Creation (dielectricity) and radiation (magnetism), and their two byproducts, electricity and mass, or gravity as centripetal attributes choate to mass / matter.

Below: Conjugate relationships of induction, creation, and capacitance

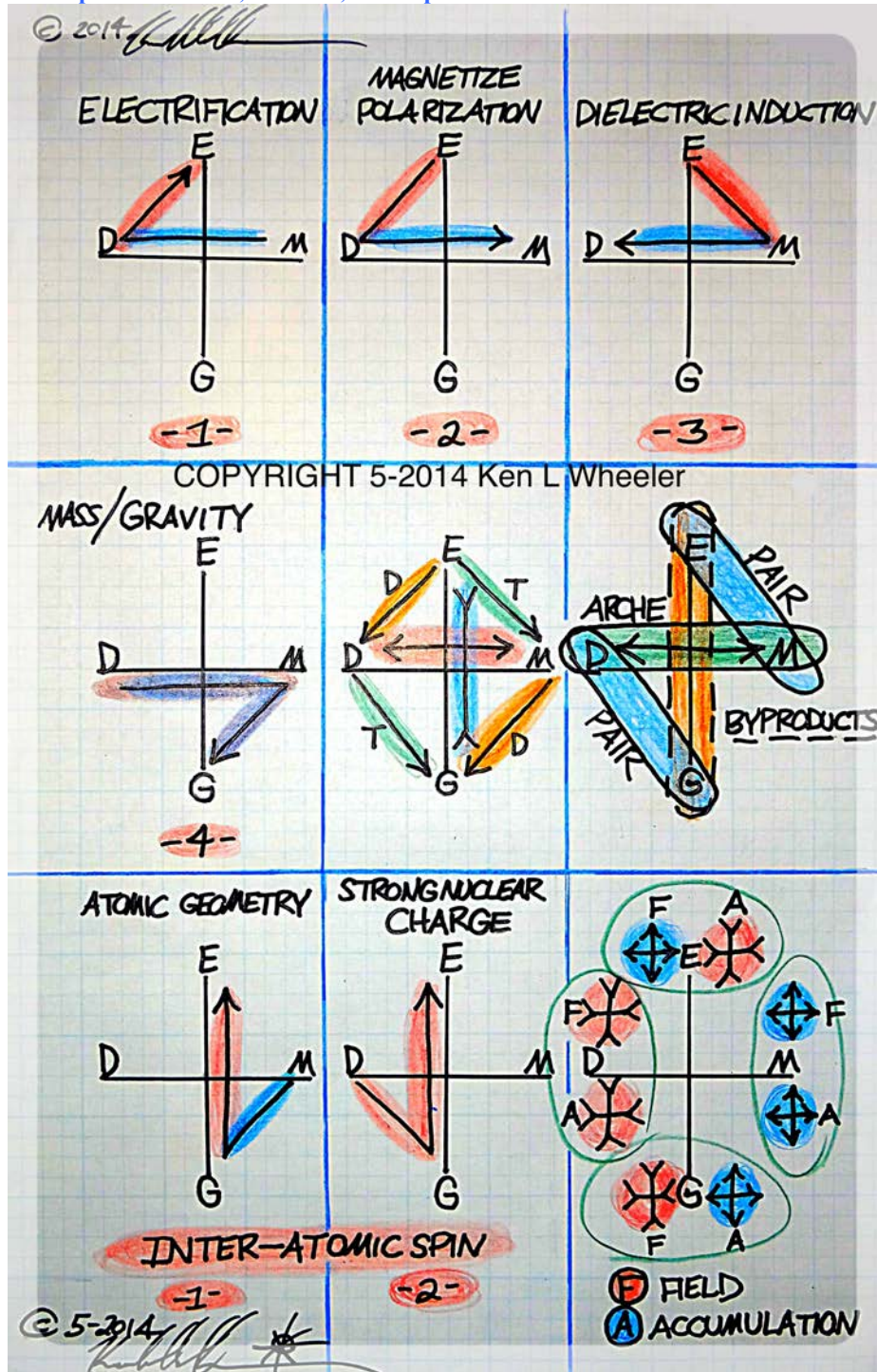

Below: Force Unification chart showing field and force unification. Copyright 5-20-2014 Ken L. Wheeler

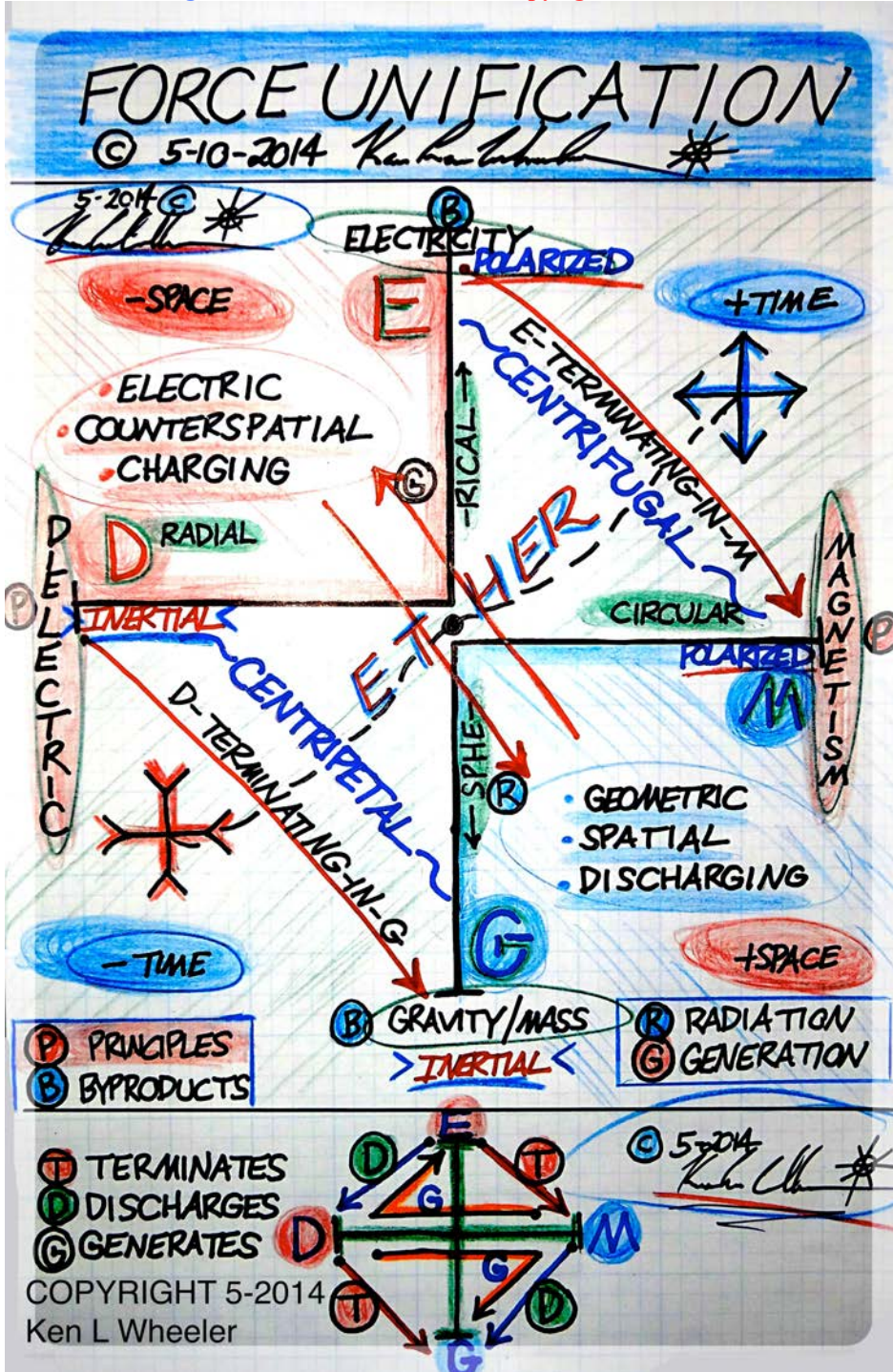

Below: Force Unification chart showing field and force unification. Copyright 5-20-2014 Ken L. Wheeler

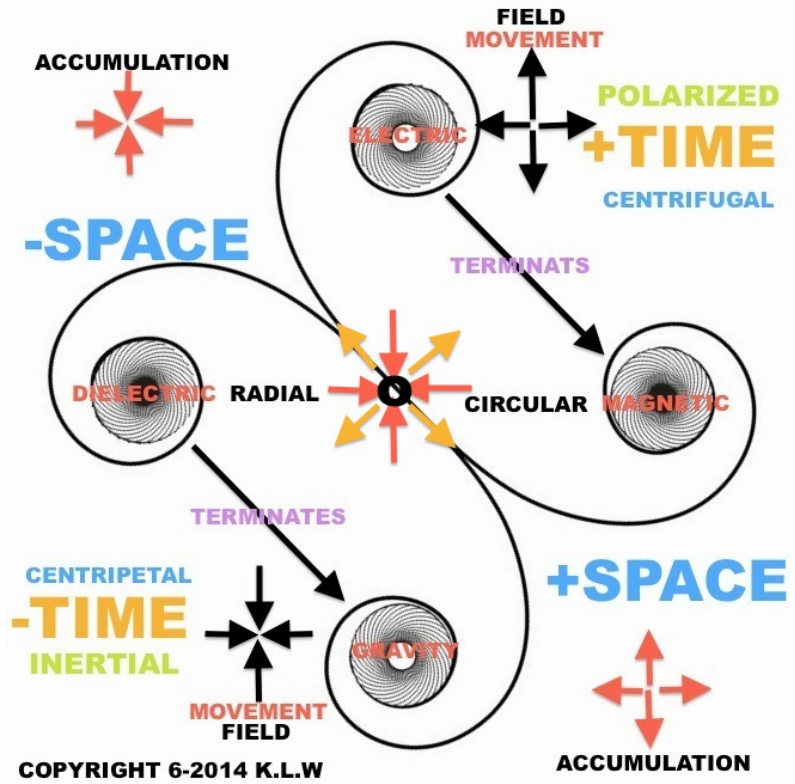

ALL DIRECTIONS ARE ACCUMULATIVE, SPATIALLY OR COUNTERSPATIALLY, THROUGH A NET-0 ETHER FULCRUM

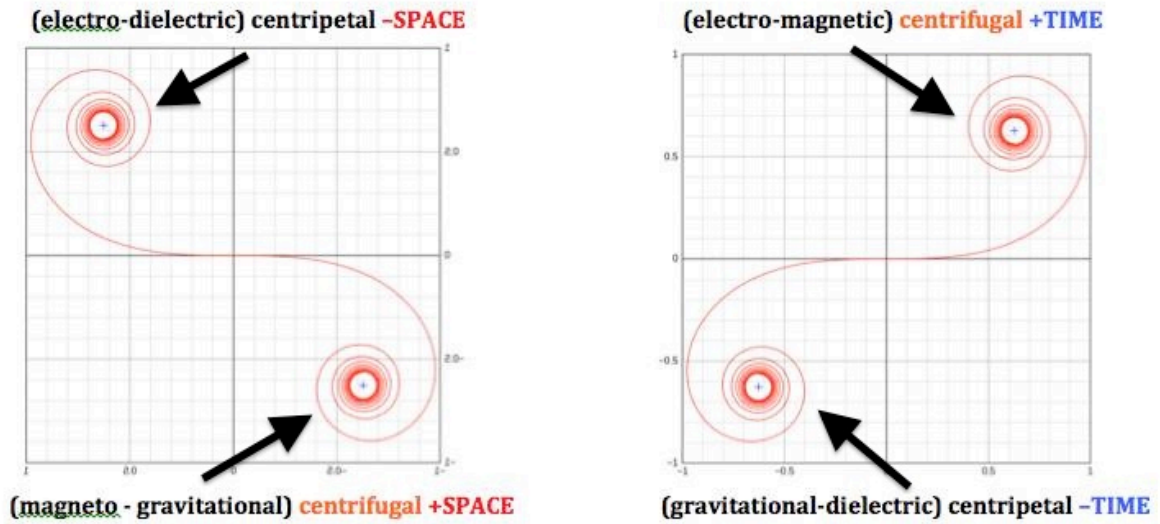

ALL CHARGES, DISCHARGES, CENTRIPETAL & CENTRIFUGAL MOVEMENTS CONJUGATE IN SPATIAL AND COUNTERSPATIAL ACCUMULATIVE EQUILIBRIUM

Below: 3D representation of Euler spiral field and force conjugation



Below: One need only to hold up a circular Moire' pattern (representing magnetism) against a linear (dielectric inertial plane) Moire' pattern and move both back and forth just a bit to see what is occurring in the process of creating electrification. **Quite literally, electrification is the product of the counterspatial dielectric geometry interacting, over time, with the magnetic spatial circular geometry creating an Ether-based interference preturbation with the resultant perpendicular creation of electricity.** On the left we have circular magnetism and middle, the radial dielectric, on the far right we have the product of the two, electrification.

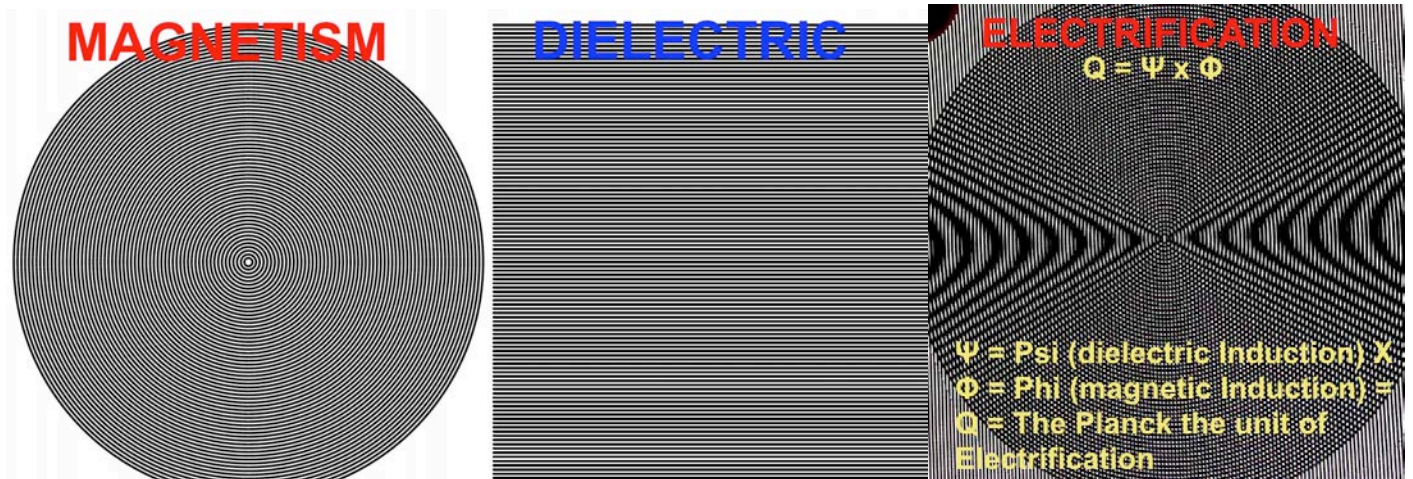

Likewise if you layer two horizontal dielectric Moire' patterns perpendicular to each other to represent the dimensional interlacing radial grid pattern in the conductor, and then move the circular magnetic Moire' pattern over both of those you will get the full picture of both the electrification and magnetic induction occurring in the conductor.

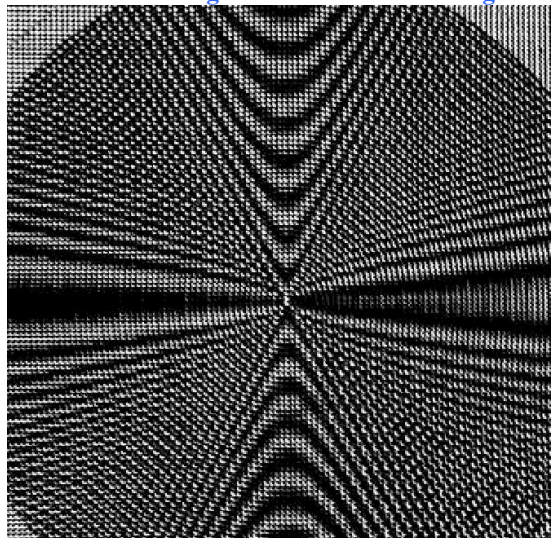

Magnetic precession rates of the gyromagnetic-ratio at 42.4923 Mhz/T in creating the magnetic vortex
 Precessional (vortex) Geometry is also Phi-Phi-1Precession

Precession is a universal absolute and constant in a conjugate system of fields where magnetism moves opposite to dielectricity

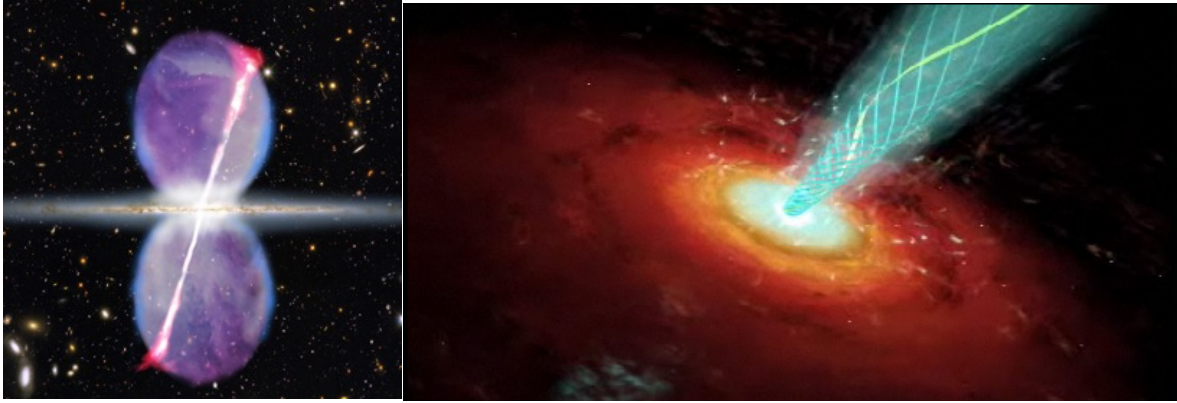

In the magneto-dielectric double hyperbola disk model, precession is due to the nuclear magnetism inherent in the proton(s) at the center of every magneto-dielectric atomic volume which is caused to precess by the powerful dielectric inertial plane and likewise therefore the magnetic expanding Z-axis polarized plane to precess in kind to its apex initiator, the protonic nucleal dynamo which is being impelled to coherent phased precession by the powerful and saturated dielectric inertial plane.

There must exist 3 COHERENT ASPECTS for a magnet to be a “magnet” and thereby have ‘perfect’ field incommensurability which defines a permanent (or an electromagnet) with its attributional properties. 1. XY-axis dielectric inertial planes in coherent field incommensurability alignment. 2. Expanding Z-axis circular spatial reciprocating magnetism in coherent field incommensurability alignment. 3. Phased coherent dielectric inertial plane spins all operating in the same centripetal radial movements of field incommensurability alignment.

Below: Showing the magnetic and dielectric XYZ conjugate system of both fields moving oppositionally in a binding system which also necessitates precessional movement.

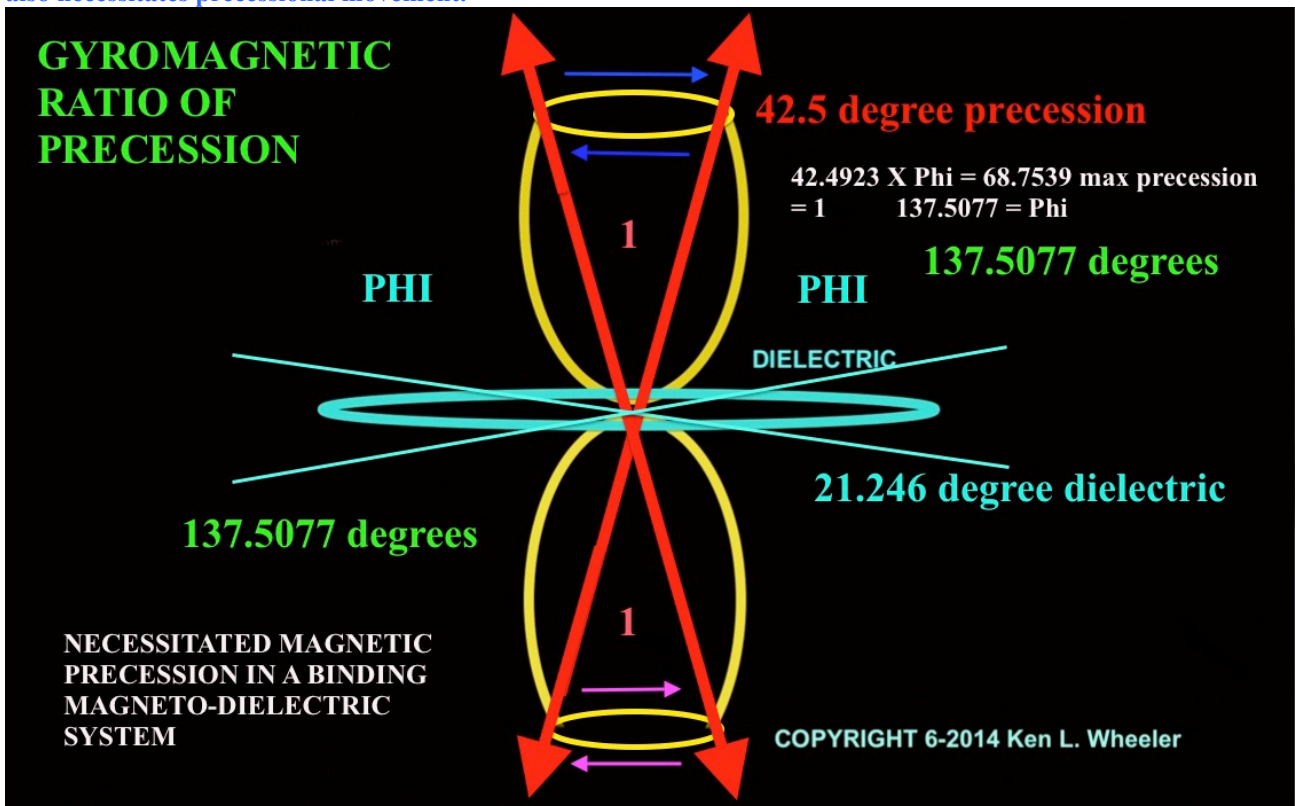

Gyromagnetic ratios, and magnetic precession is nothing of my discovery, this principle is part and parcel to **all magnetic resonance imaging (MRI), nuclear magnetic resonance imaging (NMRI) technology**, however the entire field of MRI technology is senseless and clueless that a permanent magnet exhibits this due to special magneto-dielectric field geometry. MRI use enormous power to generate these magnetic precessions, which field contrasts are then used to image and determine what is being scanned. Enormous pulsing power is used in the creation of MRI images, however a single large pulse is used to create an identical precessional magnetic geometry in the permanent magnet. As is the case with most technology, things are discovered and perfected without actually understanding or caring about the principles behind them.

Why the seeming 'obsession' with using gyroscopes in making models and analogies of magnetism? The fact is that both have 3 important axes and importantly a very near-identical fourth principle, the inertial torque plane, or flywheel of the gyroscope which is nearly identically mirrored in the dielectric inertial plane. Of the two models, the only differences are that one is physical and the other is magneto-dielectric, or purely field-based. However both employ principles of phasing, spin, inertia, coherency, and acceleration, additionally that of torque. The analogy ends of course at field inductions which are at a distance and not mediated by particles or contact.

Below: Detailed angles and degrees of precession (not to scale) in a perfect "magnet" system. Ratio of Phi-Phi (dielectric) -1 (magnetic). Or a ratio of 3.23606 dielectricity to 1 magnetic. Precessional angle and magnetic frequency is 42.4923 (~42.5). $42.5 \times \text{Phi} = 68.7539$ degrees maximum precession in the conjugate system.

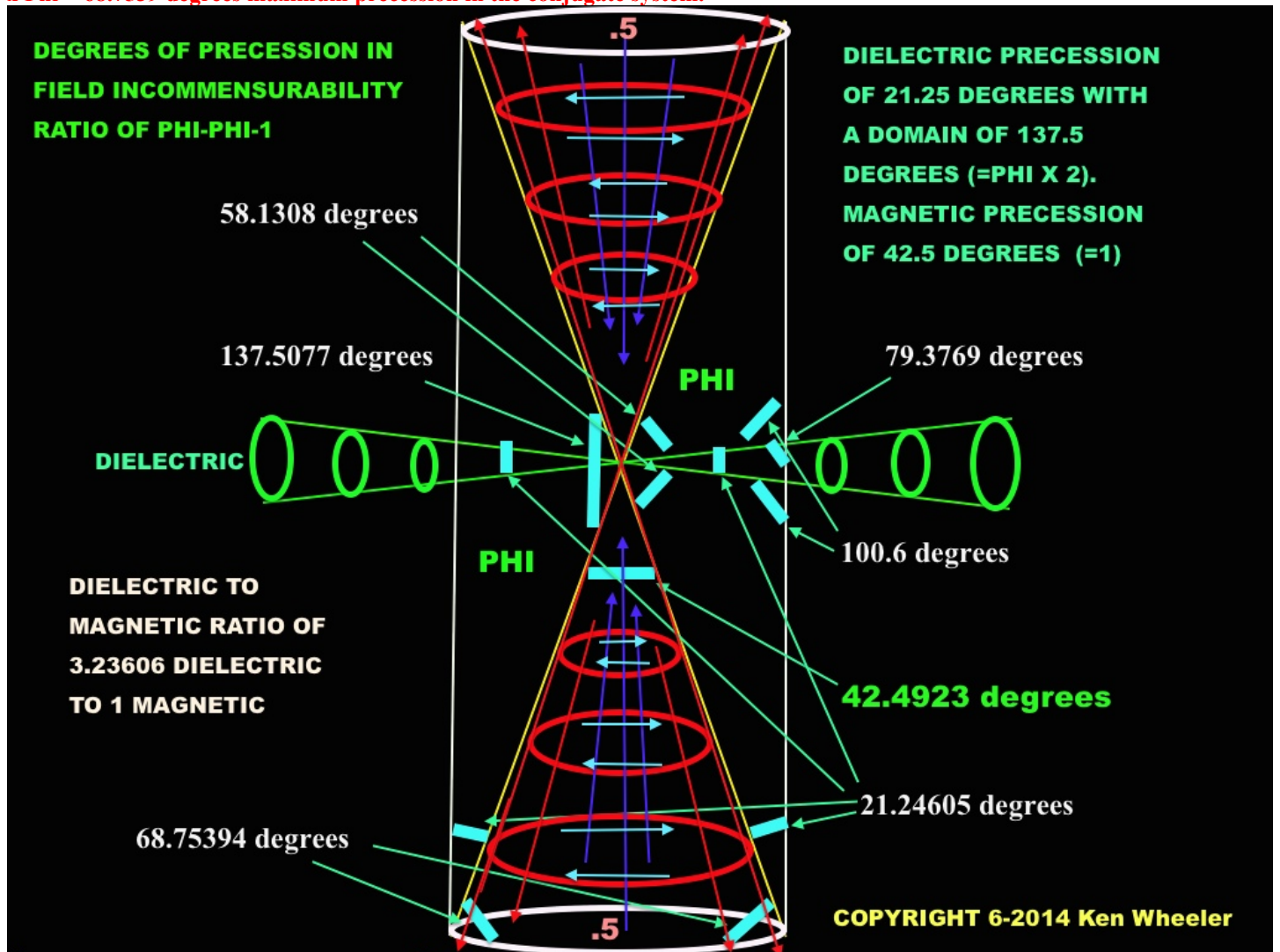

Identical to CW on CW or CCW on CCW of approaching magnets, the spinning gyroscope will raise up in the air (voidance) only when spun **OPPOSITE TO THE PHASE OF MOVEMENT** of its flywheel, if a gyroscopic flywheel is moving CW and the flywheel is moved CW, there is strong counter-voidance, however if a flywheel is moving CW and a applied CCW motion is applied to the gyroscopic system, then the flywheel will rise to that movement, which is its counterspatial apex of voidance. Magnetism is identical in that CW on CW approaches are a counter-voidance inertial plane torque of immense resistance. **Remembering that in any perfect magnet, the dielectric is 3.23 (phi times 2) times bigger than the magnetic which is 1. A ratio of 3.236 to 1.**

Below: Showing the simplex nature of a phased dielectric field causing proton(s)ic precession and likewise resultant magnetic field precession centrifugally from the apex-locus of the protons being in a state of precession. Protons are magnetically charged particles naturally regardless of the system. Both the dielectric inertial plane and the magnetic Z-axis circular field are under a state of precession. The dielectric from the centripetal returning magnetic vortex and the nucleus of proton(s), and the magnetic centrifugal field under precession from apex-nucleal proton(s) precession. **The order of causation is 1. Dielectric acceleration and saturation (from electrification in the creation of a magnet). 2. Nucleal proton(s) precessing coherently under the centripetal radial dielectric (since they are magnetically induced particles). 3. Centrifugal magnetic field precession due to the precessing proton(s). 4. Resultant dielectric precession due to magnetic reciprocation both centrifugal and centripetal around (centrifugal), towards (centripetal), and at (intermediate centrifugal) returning not at the inverse spin or 'pole' but along the dielectric inertial plane. The cycle is now complete with two fields causing and being caused into mutual precession from and towards one another in the binding system.**

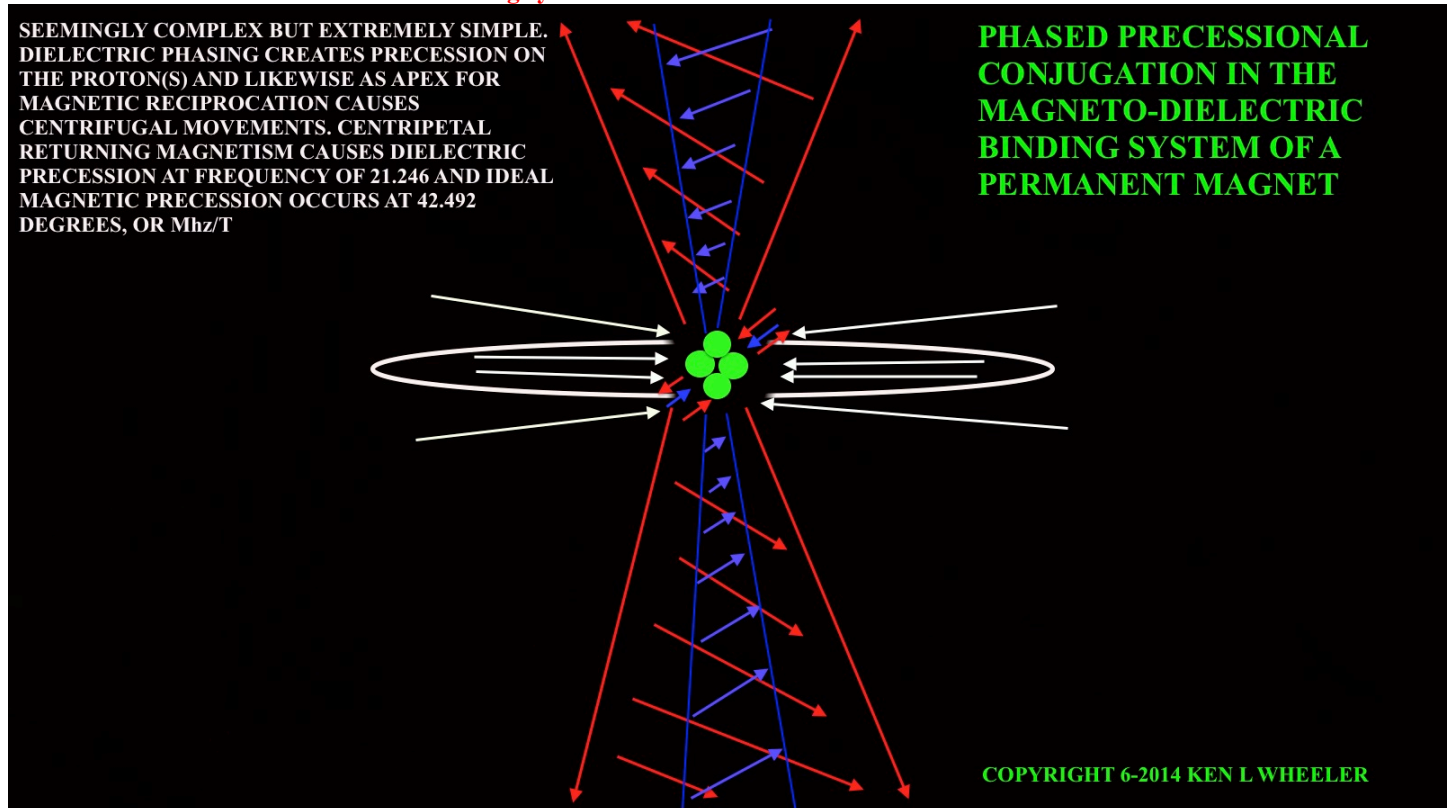

Centripetal to centripetal voidance is the operational prima causa to both gravity and to magnetism, this vortex movement to equilibrium by voidance is how both masses self-void in equilibrium and how dielectricity self-voids in equilibrium by brining low-pressure magnetic reciprocations into counterspatial collapse.

Precession and phasing of the dielectric inertial plane (being in phase once electrified) is the second attribute to the double-hyperbola-disk magnetodielectric geometry of Field Incommensurability. Coherent field incommensurability in the conjugation of inversely-moving field phenomena (magnetism and dielectricity) in a binding system necessitates this special geometry (see below) and additionally the precessional coherent phasing which comprises not only the polarization of the magnetic field which it is definitionally, but its vortex spin phenomena as the nucleal proton(s) precess against the dielectric inertial plane and likewise resultantly precession, in a vortex pattern, the polarized macro-magnetic dominances of the "magnet".

Three parts are at play in two field forces that are 180 degrees oppositional within a bounding system, the spatial-counterspatial conjugate geometry of the radial centripetal dielectricity and the circular centrifugal (and centripetal) magnetism. Both magnetism and dielectricity are, in the binding system, moving apart from each other and likewise (compounded by the returning centripetal magnetism) gimballing, or precessing against each other. Polarization is understood (from the section on magnetism below), however the last and final more complex (but utterly simplex and logical) principle of mutual field precession is necessary to demonstrate vortex movement reciprocation of magnetism in a phased system of dielectric dominance.

Below: Showing states of precession from dielectric torque being exerted upon the protons in the nucleus.

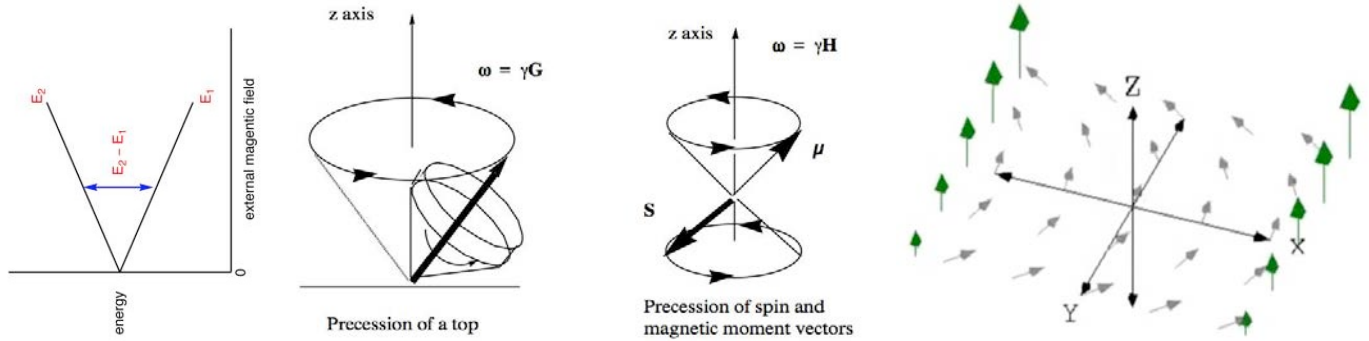

Polarization is necessitated by the definition of magnetism itself, but also secondarily, as mentioned before, magnetism never exists by itself, and only as attributional to electricity terminating thru a dielectrically capacitant mass or otherwise (TEM, circular field around AC and DC lines, etc.). This conjugate necessity of nature is, to wit, that magnetism is only present as an attribute to another which is prior (however both are co-eternal and consubstantial, or ‘where there is one you will always find the other’), i.e. “WHAT is the source or locus of polarization?” Ether being counterspatial, a polarized spatially expanding Ether disturbance is secondary to a precedent initiating the polarization. In the case of a “magnet” (dielectric object) the dielectric inertial plane causes precession of the apex situated proton(s) which likewise cause necessitated precession, however the perfect equilibrium of precession against the dielectric plane is a ratio of 1 against Phi. This angle is 42.492 (42.5~) degrees, which is also the frequency in Mhz/T of the proton, however this is incorrectly published as 42.5781, it is at perfect equilibrium at 42.492, but this is a minor difference.

Below: Left, showing protonic precession from radial dielectric influence. Middle and right, showing the precessional geometry as products of acceleration, force, and lateral torque.

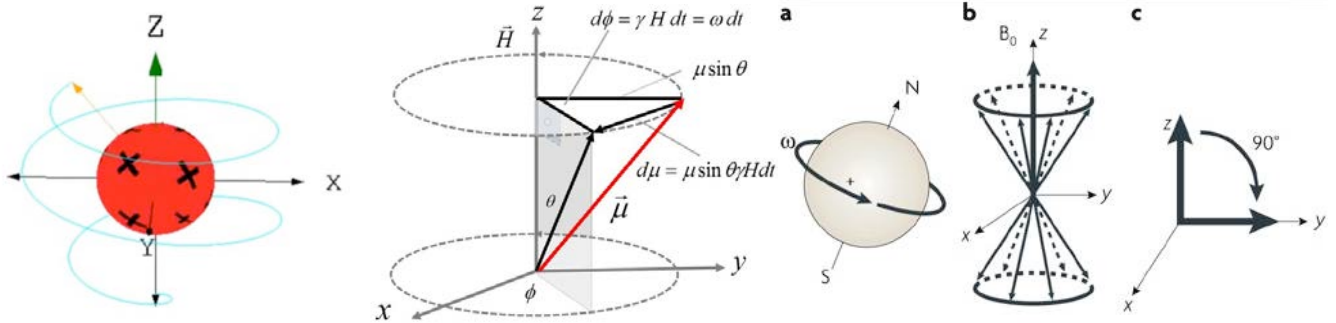

In a perfect magnet, with perfect properties, **the ratio of the presence of dielectricity to magnetism is 3.23606 (phi x 2) quantities of dielectricity to 1 part quantity of magnetism.** This is why a “magnet” is really a dielectric object, however the counterspatial and radial qualities of dielectricity make this almost unapparent to any conventional sensory observational inquiry.

Since magnetism is radiation by definition, this resultant “permanent” charge ratio of 3.23606 dielectric to 1 part magnetism (in a perfect example) is kept in place. If it were on a 1 to 1 ratio, then after capacitors banks dropped the pulse charge to the coils to induce dis-equilibrium into the “magnet” in creation, then the resultant, of course would be no different than before electrified induction from the coils into the “magnet”. This special ferrous, or lattice-neodymium composite (especially) allows for dielectric charge retention ‘permanently’, unless of course destroyed from charge, shock, heat, etc.

The feature of a spinning gyroscope is that it appears to defy gravity and precess, whereas a non-spinning gyroscope falls down. The cause of the precessional motion and the gyroscope’s stability toward falling is attributed to the external force of gravity, however this is incorrect, it is due to centrifugally spinning mass moving against a centripetal field locus created at the center of the flywheel from counter-natural movement, and this likewise is the counterspatial torque inherent to a physical gyroscope causing its precession, and exerts a torque "sideways" on the angular momentum vector. This torque produces the non-intuitive result of precession. By analogy, in the presence of an applied dielectric field, the coupling of the magnetic polarized reciprocation with the dielectric field produces a torque that precesses the expanding Z-axis radial magnetic vectors and causes them to precess about the dielectric field movement.

Below: Showing precessional movements based upon torque, and lateral forces of dielectricity upon the nucleus which induce centrifugal spin upon the Z-axis expanding and reciprocating magnetic fields.

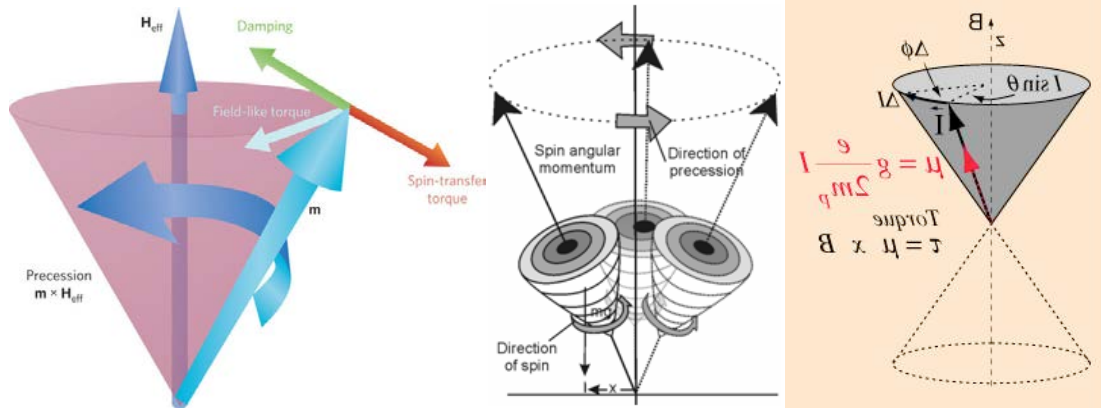

Protons precess coherently when in the presence of a powerful dielectric field. The frequency at which the precession occurs is called the Larmor frequency. This causes an oscillating and precessing magnetic field that can be measured.

In electrification in the creation of a “magnet” not only are the XYZ vectors of magneto-dielectric inertial planes brought into coherency, so too are the directions of their dielectric ‘flywheels’ all amplified to the same direction. Just like our gyroscopic analogy, you can have 10 gyroscopes with their flywheels all spinning in different directions and yet their XYZ axis of the magneto-dielectric volumes are still aligned, however in touching all 10 at the same time, you will get variegated precessional incoherent reactions. However as is in the case with electrification and dielectric saturation in the creation of a “magnet”, all dielectric inter-atomic fields are accelerated in a singular pulse of phased dielectric coherency. This is also why CW on CW magnetic approaches causes immense Ether pressure resistance (counter-voidance), because the dielectric-momentum of all the many trillions of atoms in the “magnet” are resisting breaking torque from an outside pressure of counter-voidance. This is in-phase precession post-electrification in creating a magnet.

Below: Precessional model in reverse, where a counter-voidance magnet hanging from above is causing precession in the axis (nucleus) of the inertial system below it. In the correct model, reverse of below, the dielectric inertial plane is causing nuclear precession and resultant Z-axis magnetic field precession, the source of vortex circulation of any magnetic system.



The creation of a magnet from dielectric saturation is the first step in creating macro-magnetic predominance, but the in-phase magnetic precession in electrification is the driving power behind “strong attraction and repulsion” (rather voidance and counter-voidance). This dielectric phasing causes proton(s) precessional coherent phasing and likewise in kind magnetic field phasing. All pressures are precessing and polarized against lowest pressure reciprocation.

The cones of possible orientations become cones of possible precession for the angular momentum and magnetic vectors in the presence of a coupling dielectric field.

Below: Dielectric phasing in the creation of a magnet is responsible for the enormous torque of either voidance or counter-voidance ('repulsion'). This enormous compounded torque from trillions of in-phase inter-atomic dielectric inertial planes is a main component of the inaccurate assumption that magnetic "attraction or repulsion" is driven or has its causation in the magnetism itself, when in fact this is due to the in-phase dielectric.

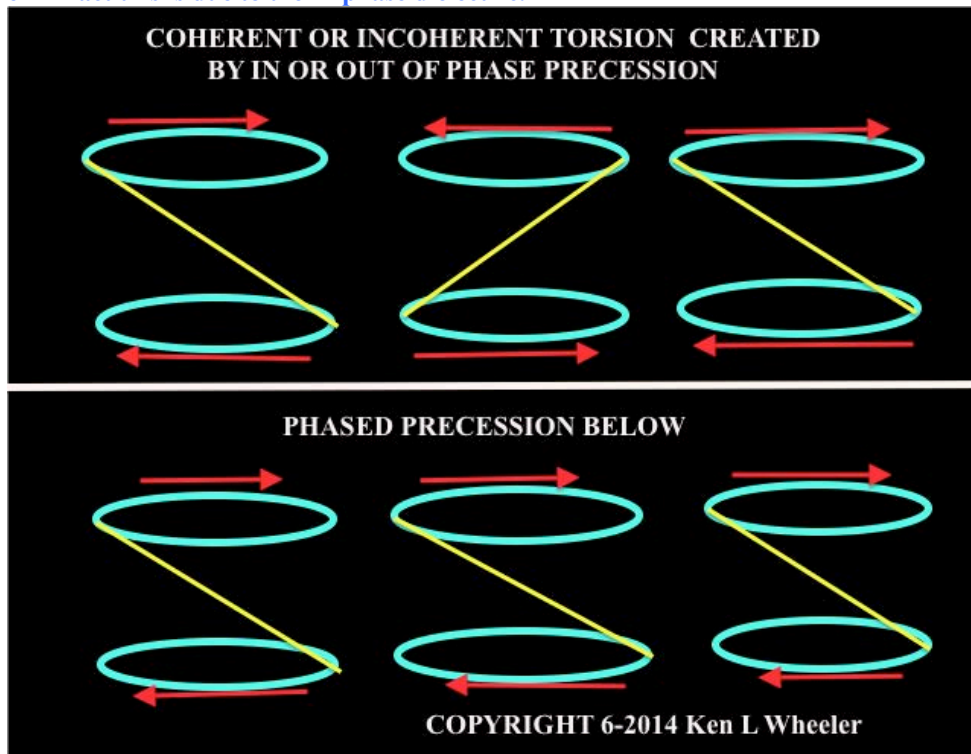

The classical vector properties of the angular momentum of a gyroscope are analogous to many of the important characteristics of the vector properties of the mechanical magnetic inertia. The reason for the close analogy is due to the important and critical connection between the dielectric inertial plane and the angular momentum due to the dielectric's acceleration, or spin. For example, the rotating mass of a gyroscope possesses angular momentum, which can be represented by a vector whose direction is along the symmetry axis of rotation. A gyroscope in a field precesses, i.e., the axis of its rotation precesses around the direction of the counterspatial field. What factors determine the rate of precession of the gyroscope? The answer is the field force at the center of rotation and the inherent angular momentum of the gyroscope, or in this case the dielectric plane and its acceleration. If the angular momentum, which is determined by the angular velocity of spin and the mass of the gyroscope, is constant, the rate of precession ω is determined only by the centripetal field force, so that there is a proportionality between the rate of precession and the centripetal field force, where γ (compare to the magnetogyric ratio) is the scalar proportionality constant between the precessional frequency and the centripetal field force. ω (Larmor frequency) = γeH

Below: Phased magnetic and dielectric precession in a coherent “magnet”. Component factors necessary are the XY dielectric inertial plane, the Z-axis magnetic circular reciprocation, and the in-phase spin of the XY-dielectric inertial planes operating in unison.

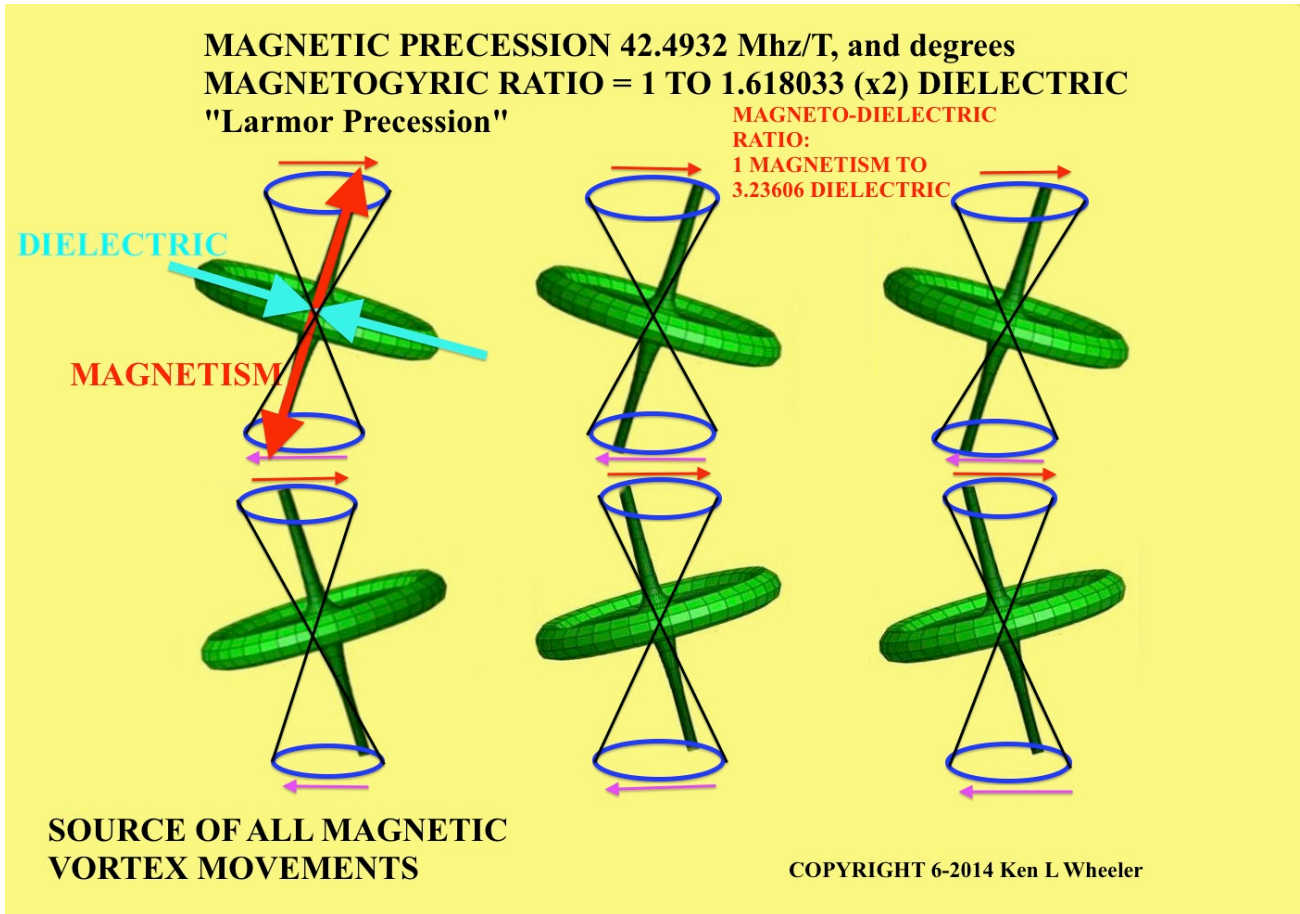

Magnetic pressure gradients along the golden ratio at 137.5077 degrees common to phyllotaxis
 Field (static) Geometry

“Nature grows, reciprocates, moves, flows, and radiates always along the lowest lines of field pressures” – Author

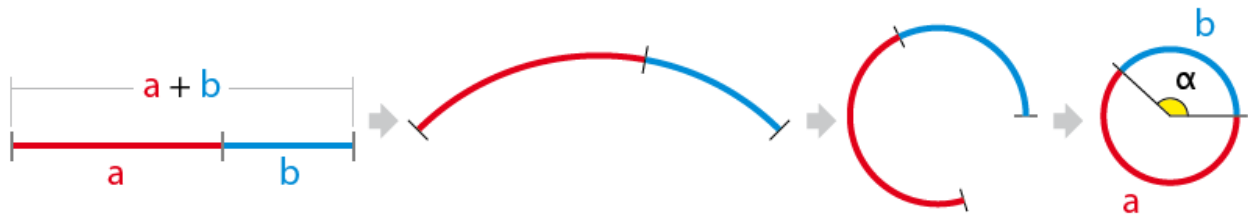

$$\frac{a}{b} = \frac{a+b}{a} = \varphi (\text{Phi}) = 1.61803399... \rightarrow \alpha = 137.507764^\circ... \sim 137.5^\circ$$

Discovery: Magnetism does and must (as do all fields) reciprocate along the lowest pressure gradients out and thru and back again. It cannot be any other way. Without looking for it or expecting to find same, it turns out that all magnetic stable centrifugal and centripetal vortex lines radiate and reciprocate in a pattern identical to the sunflower and other growth organizations at 137.52788 degrees. Magnetic pressure follows lines of **360(degrees) / 85 degrees = 4.23606 degrees**, of which the golden circle of centrifugal and centripetal vortexes both move is; **360(degrees) x Phi^-3 = 85 degrees**, and likewise move at **360(degrees) x Phi^-2 = 137.5077 degrees**. 85 is to Phi as Phi is to 1, additionally 137.5077 is Phi, at which the movements are at **360/85 (=Phi cubed)**. The dielectric radial centripetal accretion disk of the inertial plane is narrower in reality than 36 only due to intervening magnetic pressure gradients. Its ideal geometry however extends out to 36 degrees, nevertheless however the golden ratio proportions are kept throughout.

Below: Sunflower phyllotaxis growth and the shape of magnetic field recirculation lines

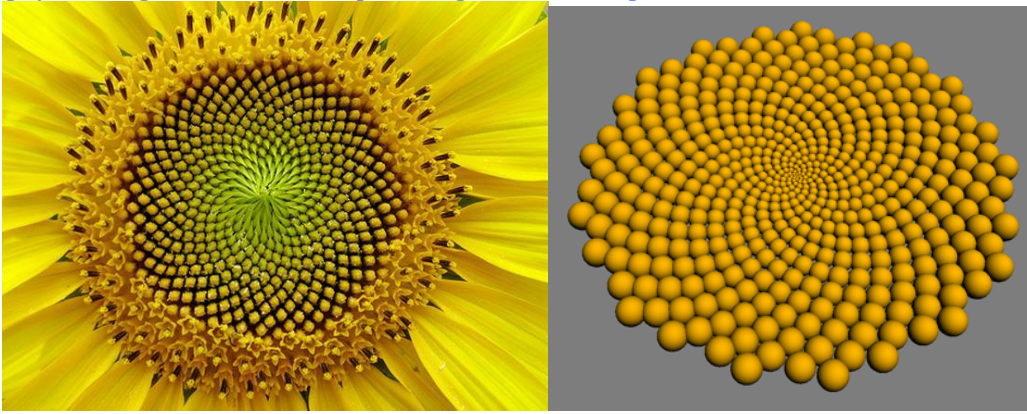

Below: Left, torus centrifugal flow around a disk magnet, right magnetic pressure gradients with high pressures showing raised, not to scale. This same pattern on the right is reproduced in electrification of the dielectric inertial plane against a magnetic field over time.

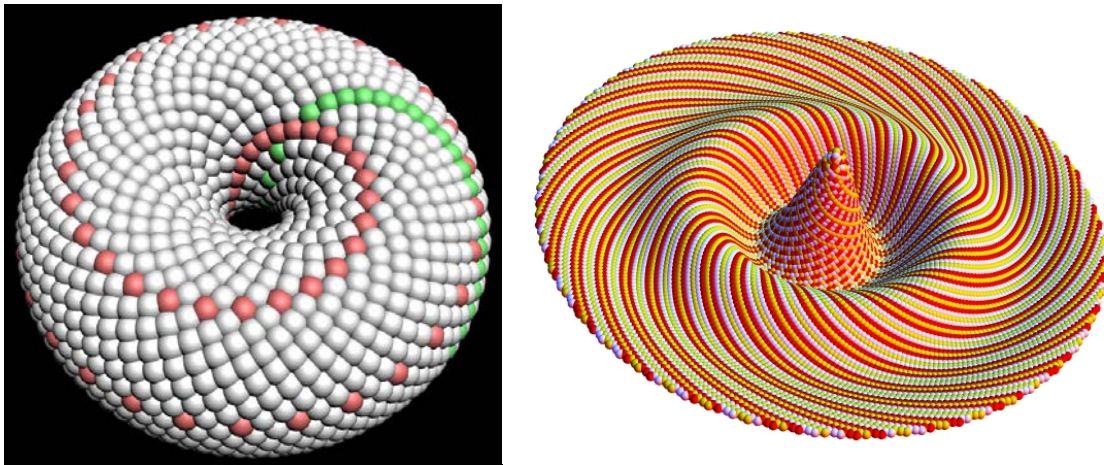

Below: Moiré' patterns used to demonstrate field line forces, either like on like spin, or inverse interlacing and (voidance) co-joining

moiré patterns

CW ON CCW, OR CCW ON CW
MAGNETIC VORTEX FIELDS
COMING TOGETHER

TOGETHER

CW ON CW, OR CCW ON CCW REPELLING DUE
TO ETHER PRESSURE. LIKE ON LIKE IS ITSELF
POLARIZATION. LIKES DO NOT ATTRACT!

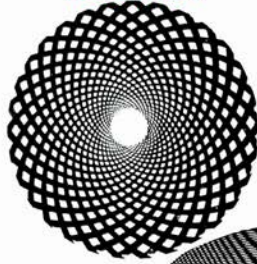

COPYRIGHT 2014 KLV

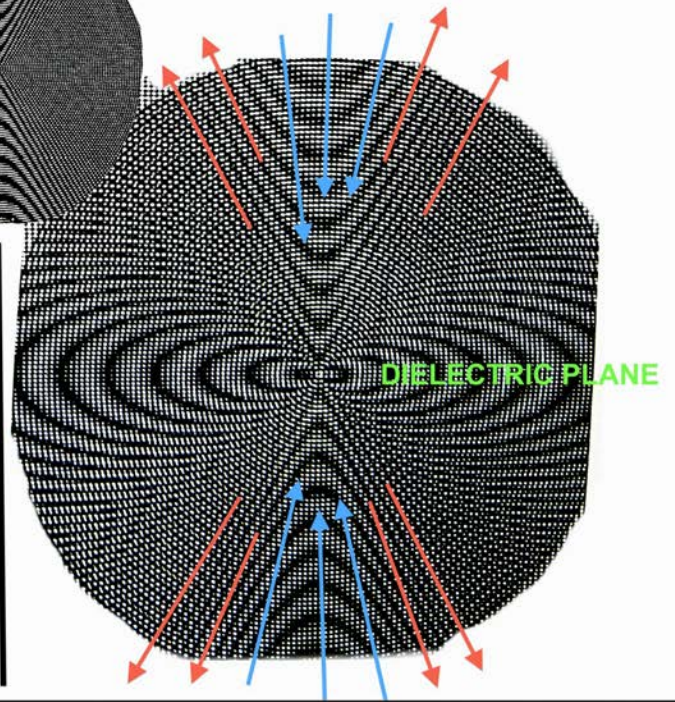
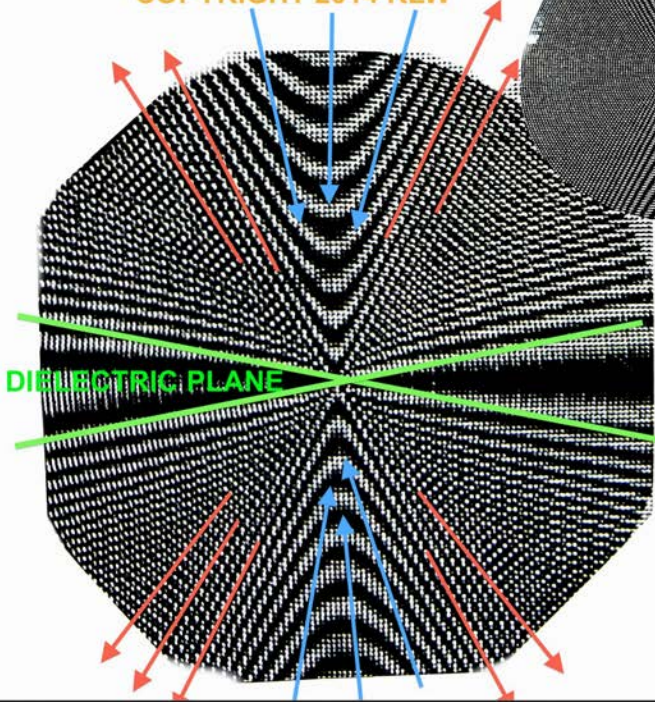

Below: Natural scroll wave patterns in nature as also found in magnetic field reciprocity

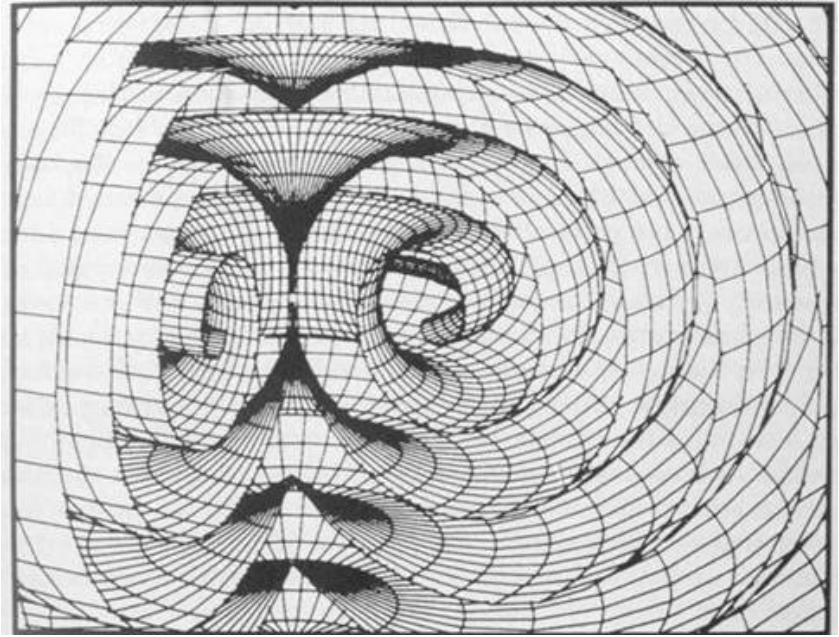
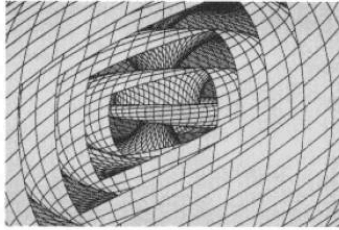
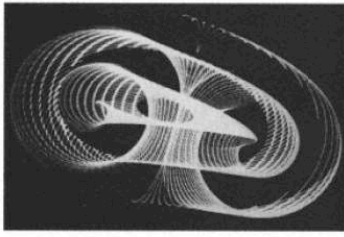
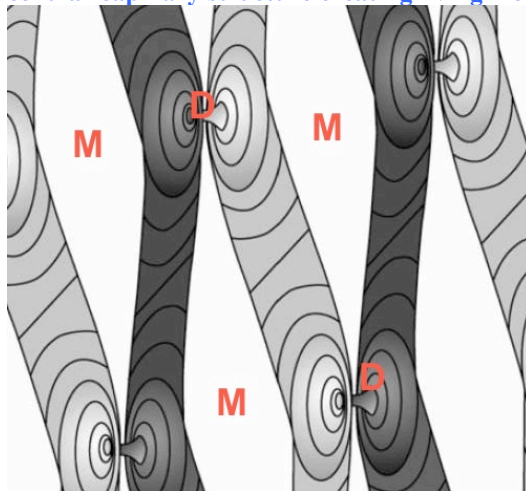
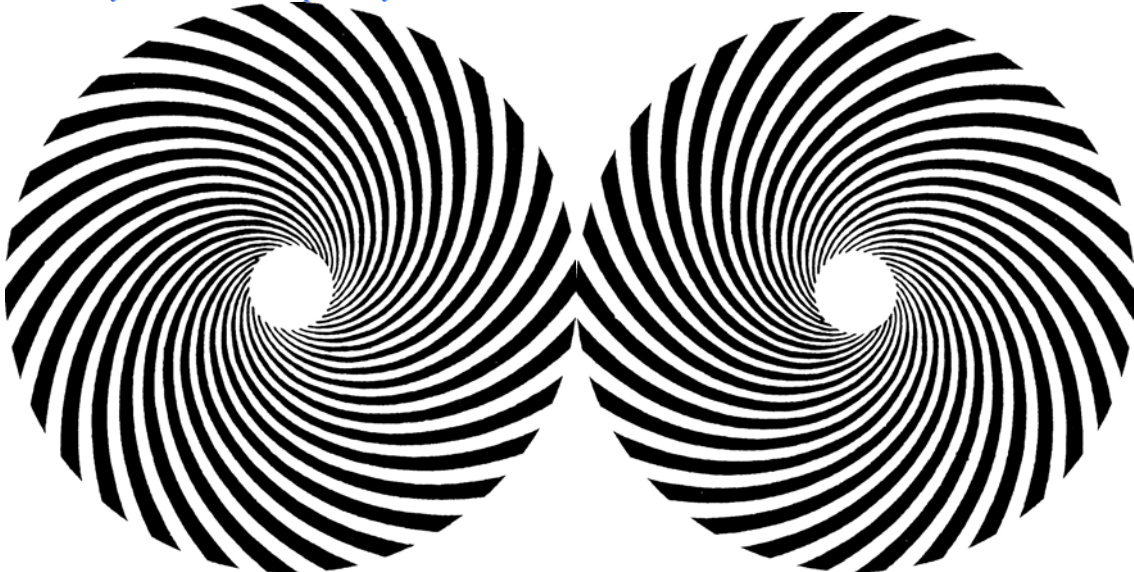

Fig. 3.6
The patterns in a three-dimensional BZ mixture are more complex. One of the simplest, the analogue of a two-dimensional spiral, is the scroll wave (a), which can curl up on itself to form a scroll ring. Twisted scroll rings have more complicated structures (b). (Images: Arthur Winfree, University of Arizona.)

Below: M(magnetism) and D(dielectric) cellular capillary structure creating living membranes from charges and magnetism



Below: Print these out yourself on transparency film to see how CW on CCW or CW on CW or CCW on CCW behaves



What is a magnet & magnetism, really?

"I have found great difficulty in conceiving of the existence of vortices in a medium, side by side, revolving in the same direction about parallel axes. The **contiguous portions of consecutive vortices must be moving in opposite directions**; and it is difficult to understand how the motion of one part of the medium can coexist with, and even produce, an opposite motion of a part in contact with it. In (a mechanical) mechanism, when two wheels are intended to revolve in the same direction, a wheel is placed between them so as to be in gear with both, and this wheel is called an 'idle wheel'. The hypothesis about the vortices which I have to suggest is that a layer of particles, acting as idle wheels, is interposed between each vortex and the next, so that each vortex has a tendency to make the neighboring vortices revolve in the same direction." - **James Clerk Maxwell**

"Divine? Holy, or unholy? What be this invisible force, this magnetism that can pull iron from the other side of my hand with no care or notice of same?" – **old poem**

"Magnetism is the dielectric field" – **Michael Faraday**

"Magnetism is the discharge Ether modality of dielectricity in termination. Dielectricity is counterspatial, magnetism is spatial. All radiation, all discharges in the universe are spatial by nature and definition. Magnetism, therefore is the necessitated polarized (creates space) co-eternal conjugate to dielectricity. Electricity terminates AS magnetism, not INTO magnetism, by losing its dielectric component as necessitated; electricity is the product of Phi (magnetism) and Psi (dielectricity), is definitionally a hybrid Ether modality of the product of Phi and Psi." – **Author**

"The supreme irony is that the notion of "electromagnetism" exists at all, which definitionally cannot exist, since electricity is the product of electrostatics and magnetism, as meant dielectricity and magnetism ($\Phi \times \Psi = Q$, or **electrification**). To say "electromagnetism" is like saying, "charging-discharge", or "pregnant baby"; it is insanity. The very term 'electromagnetism' is a compound of two Greek terms, **ἤλεκτρον**, electron (amber, which creates, easily, electrostatics charges), and the term **μαγνήτης**, 'magnetic', from (μαγνήτης λίθος), which means "magnesian stone", the "magic attractive stone" with natural macro-magnetic phenomena. Electricity is a hybrid Ether-modality of $\Phi \times \Psi$. Magnetism is the radiative discharge of dielectricity, or electrification in discharge at which time it terminates AS magnetism in losing its dielectric component. Pliny states that: 'in Syria the women make the whorls of their spindles of this substance, and give it the name of harpax (from ἀρπάζω, "resonate, attract", same as the word for harp musical instrument) from the circumstance that it attracts leaves towards it, chaff, and the light fringes of tissues.' As such we have today the term electromagnetism which is from the terms dielectricity + magnetism, which is what electricity is. However we wrongly understand and fail to differentiate magnetism, from dielectricity, and electricity. These three are wholly separate Ether modalities and electricity is a hybrid of both magnetism and dielectricity in a circuit working together to create electricity." – **Author**

Below: Ancient Viking amber whorl, which when spun in creating thread, would cause an electrostatic charge to form.

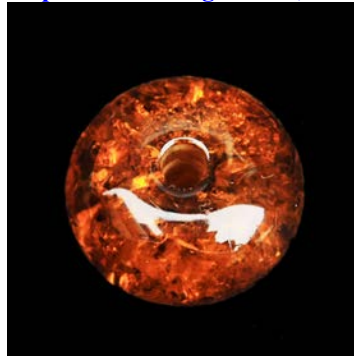

The format of this and other sections of this article are created in a manner of simplicity in a non-traditional fashion to keep salient points isolated from one another. To compact as much pithy information as possible into this article I have serialized the point-thoughts to sound bites for simplex digestion and comprehension. Not only has this made proofing the material much easier, but also localized thoughts can be expanded and given the attention they are meant to have in this article by their isolation and unthreaded formatting style.

What you can and should take away from this article, and magnetism specifically is the extremely simple, but not simplex nature of what magnetism is, both in whole and in part, and dispel many of your long held and erroneous convictions about attraction, repulsion, how magnetism works and interacts. What generates magnetism, and why its geometry is the way it is, but more importantly why it cannot "be any other way" than it is. Nature does not move against itself like a fisherman walking against the stream. Greater pressures override lesser ones and conjugate reciprocation is endless in this universe, both in macro and micro. However the understanding of this as relates to magnetism and inter-atomic operational vectors and geometry on the electrical and magnetic is extremely poorly understood and even worse.

The ordering of the salient points below is not linear, but, like a magnet, is reciprocating, however if you bear thru at least half of this section on magnetism you will understand what a magnet is in full, how it works, why it works, what is the nature of its magneto-dielectric field mechanics. So stroll through these points and clarity will unfold as to the nature of magnetism like you have never seen it before, but more importantly, most importantly, its accurate unfolding.

The missing component to magnetism is, as will be spelled out, is that magnetism and dielectricity are the two components of the universe. Magnetism the spatial (however space is in a field, not the inverse), circulatory, radiative, and polarized both centrifugal and centripetal and the dielectric is the inertial, centripetal, counterspatial, and radial; magnetic spatial radiation, and dielectric generation, or inertia. Understanding this conjugate relationship of magneto-dielectricity is a fundamental mandatory principle to grasping magnetism and the nature of how electrification operates in the creation of a magnet, and that a magnet can then be seen for what it really is; and as it pertains to how humans throughout all of history have looked at a “magnet”, has really been looking at a horse’s rear without ever having seen its head. However almost all of us have labored under this delusion for all our lives, been taught same, and all of us are at fault. By “standing on the shoulders of giants, I have seen much further”, so I give great credit for some of the “missing keys” to this mystery to J.C. Maxwell, C.P. Steinmetz, Tesla especially, Oliver Heaviside and a few others. As Eric Dollard himself has stated, this ‘quantum mysticism’ of insanity and nonsense as espoused by Einstein and his priests has run over rationality and common sense. Nature does not operate irrationally and quantum is, thanks to many brilliant minds, dying quickly. The revival of rational physics and understanding is returning after a century of “deep thinking insanity”.

Magnets are not magnetized objects, they’re electrified into dielectric coherency at the inter-atomic, the resultant magnetization is merely the byproduct of electrical saturation in the ferrous material of a specific nature (iron, or Neodymium-Iron-Boron or otherwise), which allows a permanent (in the case of a permanent magnet) macro-magnetic effect to remain in place. All magnets are by their nature electrical-dielectric-magnetic atomic geometries, either permanent or as temporary fields induced in electromagnets.

Electrification of a pre-“magnet” literally ‘winds the mainspring’ of dielectricity, which rolls the ‘hands’ of magnetism along in a reciprocating vortex. However unlike our watch, which eventually unwinds its mainspring, the permanent magnet has a (almost) perpetually unwinding-self-winding mainspring. How can it self-wind while at the same time unwinding? Because of the nucleal dynamo nature of the “magnet” mass at the atomic level remains in place which winds all atoms in nature for what to humans seems a perdurable eternity, however merely a blink in the eye of nature obviously. This is part and parcel of the magneto-dielectric ‘elasticity’ of iron and iron composites (neodymium iron boron) which can be, as pertains to their respective fields, squeezed intensely and hold that field shape. In the case of the “magnet”, in its creation it is, like a clay sphere, squeezed around its equator into a choke point where you have a resultant hourglass, or dumbbell shape (see multiple diagrams and proofs below) with the choke point being the immense dielectric inertial plane and likewise the spatial hyperbolas being the magnetic after-effects from the electrification.

A magnet is, in reality, a magneto-radiative mass due to A: magneto-dielectric ‘elasticity’ of ferrous materials B: electrification of the ferrous mass which causes greatly increased dielectric capacitance and macro-magnetic preponderances. Magnetism itself is the inter-spatial circular atomic medium (Ether), which mediates between the atomic charges and dielectric capacitance of the atomic volume. Electrification causes a unique (very common however in nature, as proven below) magneto-dielectric geometry to form (see diagrams below), as must be the case since magnetism is spatial and the increased magnetic induction can no longer be contained within the inter-atomic volume (in equilibrium). This special geometry works as a unified field in a coherent conjugate phase to create a magnetic double-hyperbola as resultant from dielectric amplification, as meant capacitance of the magnetic mass which has been electrified (see diagrams below). Conventionally we humans consider this ‘action at a distance’ spatial-counterspatial geometry of reciprocating magnetism as unique, however it is incredibly common (proven below) but uncommon to exist outside of the inter-atomic geometry in such a ‘powerful’ fashion as we make note of in the permanent magnet which has fascinated humanity for ages.

Below: Cube magnet under ferrocell showing magnetic field reciprocations, centripetal and centrifugal.

NEODYMIUM CUBE MAGNET BEHIND FERROCELL SHOWING EITHER POLE. IMAGE RIGHT SHOWING DEPRESSED 'BOWL' FORMATION OF CENTRIPETAL MAGNETISM OF CONVERGENCE. WHILE THE FERROCELL CONTAINS AN INCREDIBLY THIN DILUTED LAYER OF FERROFLUID, THE EXTREME DEPTH OF MAGNETIC FIELD VIEW IS STARK AND DUE TO THE LIGHT BEING SHOT AROUND THE PERIPHERY OF THE FERROCELL AND DEFLECTED BY THE MAGNETISM AND DIELECTRIC INERTIAL PLANE (CENTRAL VERTICAL LINES). WHILE THE CUBE MAGNET FACES ARE FLAT, THERE IS A BOWL-SHAPED DEPRESSION, THE CENTER OF WHICH IS THE CONVERGENT MAGNETISM, AND THE 'RIM' IS THE CENTRIFUGAL DIVERGENT MAGNETISM RECIPROCATING TO THE OPPOSITE POLE CENTRIPETALLY. COPYRIGHT 8-2014 KEN WHEELER

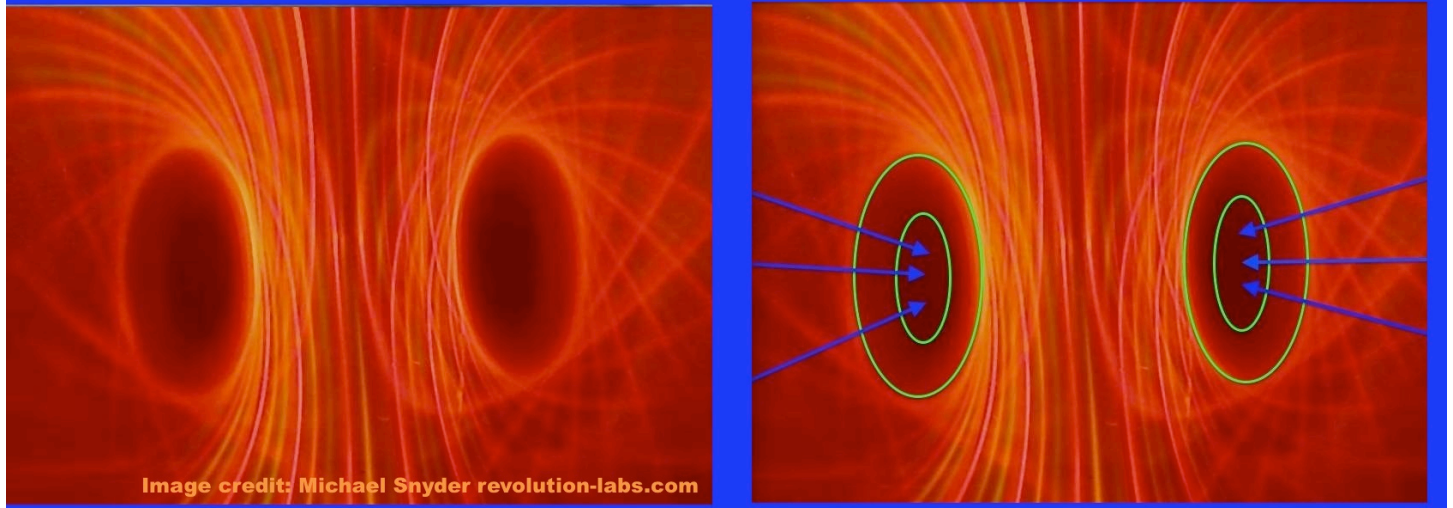

The charged mass has elongated the micro-magnetic density away from the atomic equilibrium between its dielectric and charged inter-atomic periphery. There are no electrons in or comprising an atom, as has been amply mentioned. Electrification of a ferrous mass causes the electrostatic (dielectric) naturally centripetal contraction of the atomic geometry which thereby forces and amplifies its repulsed conjugate, magnetism into the macro-magnetic spatial vector thereby by creating a macro-magnetic mass so-deemed a “magnet”. All forces exist as a counter-spatial pressure gradient, as per the Ether.

Nature only moves in spirals, never in a linear fashion, as necessitated by the null-fulcrum of action-reaction, centripetal-centrifugal, spatial-counterspatial, radiation-generation, clockwise-counterclockwise, circular-radial. All spiral movement is natural movement around a fulcrum as against its conjugate. All fields, all charges and discharges are spatial and counterspatially centripetal or centrifugal. Linear movements are not voluminous movements, of which therefore spatial and counterspatial movements of nature are spiral by nature and necessitated to be same.

Nobody can stretch a rubber band with one finger unless the band was already around a spirally curved finger expanding and transferring energy to the band in the expansion, at which time the finger was straightened, the band would fly off at 90 degrees to the straight finger. A straightening (terminating, discharging) finger induces a conjugate force into appearance. Likewise with a spiral spring in a watch unwinding causing perpendicular winding (clockwise) of the watch hands along their reciprocal null axis, being the Ether in analogy.

In speaking of “magnetism”, the immediate connotation is that of (N and S) polarity, however this spatial abstraction does not exist. Magnetism is but one force itself, however as magnetism is purely spatial in denotation it is polarized but as one moving Ether ‘sink’ and ‘bubble’; magnetism has but one movement not two, nor ‘two poles’, CW and CCW are spatial abstractions of a singular movement of the magnetic field itself. There are no static fields.

The ‘polarized’ conception of magnetic ‘polarity’ is a long held intellectual defect in electro-magnetic geometric understanding. Any spatial distention is naturally ‘polarized’ definitionally by distention. A spinning object of any variety appears to be moving clockwise from one end, and counterclockwise from the other, however the object is moving in one direction, it has ‘no concept’ of poles or polarity, only the ignorant humans scratching their heads have this perceptual defect.

There is no independent magnetism (Ether vortex) flowing thru a magnet like water thru a pasta strainer and looping back upon itself. There is no quantitative difference between a pre and post magnet but for its electrification and resultant electro-qualitative magneto-dielectric change in attribution as both coherent and macro-magnetic due to iron and iron crystalline compounds (neodymium iron boron) magneto-dielectric ‘elasticity’. There are no discrete particles involved in mediating magnetism, no quantum ‘virtual photons’

and other mythical insane abstractions dreamed up by GR and QM. All fields are Ether fields and have nothing to do with particles or rays or otherwise. Spatial and counterspatial inductions alone mediate gravity, magnetism, electricity and TEM.

Electricity only occurs at the intersection of the magnetic and the dielectric. Increased electrification of the atomic geometry and contraction of the counterspatial dielectric capacitance (increased) is pure atomic electro-dielectric saturation, but magnetism being a spatial vector (as implicitly meant polarized, implicative of its movements, CW and CCW) is expelled as macro-magnetism due to the electro-dielectric compression of the atomic geometry. Dielectricity being counterspatial is 'impelled' with increased capacitance within the atomic structure and magnetism 'expelled' without. Magnetism dissipates as heat and heat dissipates magnetism in a ferrous magnetized mass due to causing atomic expansion and decreasing the capacitance of the atomic ferrous electrical 'elasticity' in its geometry and returning magneto-dielectric equilibrium to within the atomic geometry. As the electric and dielectric radius is decreased the increase in magnetism can no longer be contained within the atomic former equilibrium.

Time, Space, Dielectricity, and Magnetism. Only magnetism is a spatial dimension, space is not calculated by space. Electrification, in Plancks is the product of magnetism and dielectricity. Only magnetism gives volume to the atomic and likewise volume to the dielectric-electric universe. Ignorantly and in error GR and QM have declared 99.9999999% of an atom is "empty space", when in fact not even .00000001% of it is empty, it's a magneto-dielectric dynamo driven by enormous nucleal rotary spin and charges.

GENUINE MODEL OF A PERMANENT MAGNET

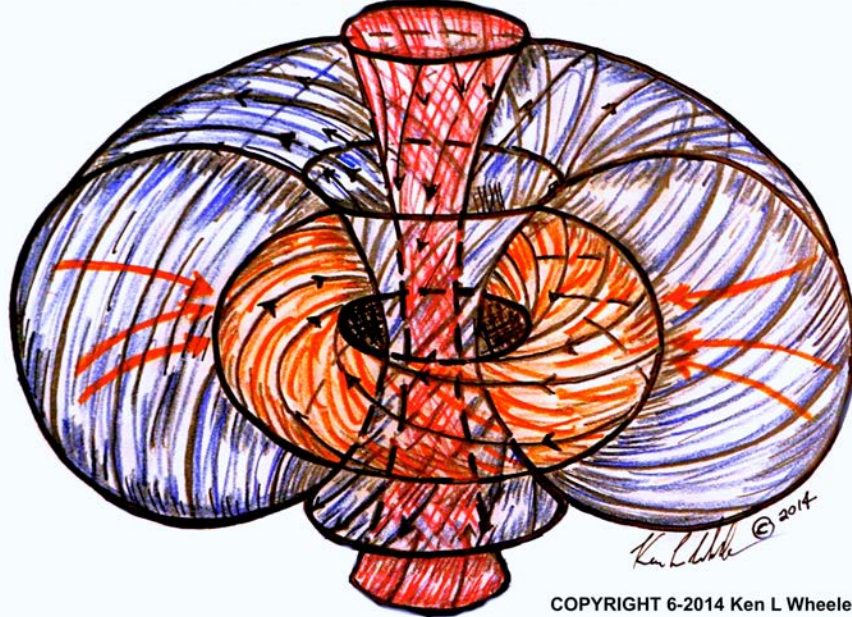

COPYRIGHT 6-2014 Ken L Wheeler

Magnetism: 1. Centrifugal (centripetal on return = polarization) 2. Circular 3. Radiative 4. Spatial
Dielectricity: 1. Centripetal 2. Radial 3. Inertial 4. Counterspatial

Non-contact magnetic induction can be easily seen and demonstrated where a magnet close to a piece of steel it will magnetically induce that steel and create a temporary 'magnet' out of the unmagnetized steel. Contrary to common belief, opposites do not attract. Like attracts like, and opposites repel. Dielectricity repels magnetism and vice versa. Magnets do not repel. Pole on pole repulsion is like on like Ether spin compression, not repulsion. Polarity is a misunderstanding of spatial CW and CCW spin (see below for more on inductive attraction).

The contracted atom from electrification increases dielectricity and expels magnetism. Counterspatial dielectric contraction due to electrification necessitates magnetic spatial expulsion. The ferrous material remains stable from electrification with its magneto-dielectric elasticity 'frozen' in place, but the magnetism is resultantly and by necessity displaced greatly from the geometric-atomic structure to be expelled from within the electric-dielectric radius of the atomic geometry. Inter-atomic volume compression from increased dielectric capacitance expels macro-magnetism, as must be the case.

Since dielectricity is a counterspatial radial Ether modality, the inertial plane constriction of the inter-atomic causes, resultant from electrification, a sharp increase of dielectricity and, atomically, expelled magnetism, which is forced, is expelled from the atomic structure. Magnetism is a versor solely of space (being circular, but not IN space, rather has an attributional quality OF space since a polarized Ether modality 'contains space' but is not in space). After being charged, the atomic mass of the ferrous material has increased capacitance and likewise being so induced, increased magnetism but not micro-magnetically rather macro-magnetically thereby creating the magnetically charged mass which has been created from electrification. Electrical saturation causes a distorted magneto-dielectric geometry and likewise therefore a magneto-spatial geometry to the special ferrous atomic structure with its unique magneto-dielectric 'elasticity'.

The dielectric-magnetic atomic architecture of ferrous materials and compounded ferrous materials (neodymium) has a specific induction and capacitance elasticity which allows the creation of permanent magnets to be electrified to create a stable equilibrium of macro-magnetic phenomena of a 'double-sink' Ether vortex movement as 'driven' by the dielectric dominance present within the electrified system.

Below: convention misunderstanding of phase creation in the making of a magnet where it is incorrectly demonstrated that "magnetic domains are aligned" and this is therefore how a coherent magnetic field is created. But this is both illogical and incorrect. The chain of causation is incorrect 100% in this demonstrably erroneous explanation that currently exists.

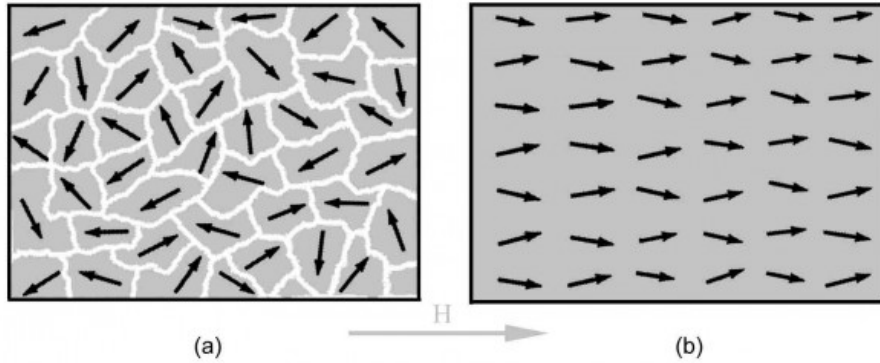

Typically as is the case of the conventional understanding of magnetism, the creation of a magnet is not the 'aligning of domains' however in microscopy this phenomena is seen as validated. The reality is rather that (see diagrams below) the incommensurability of self-similarity within any and all magnets in creation creates inertial plane accelerations in every one of the trillions of atoms making up the now electrified mass that is a "magnet". Acting as a single coherent body, the in phase electro-geometric nature of the new "magnet" self-centers both the dielectric inertial plane at the spatial middle of the magnet as conjugated against and maximum distance between either end of CW or CCW magnetic circulations, or rotations. Then the question remains, 'how does a magnet 'know' how to self-center the dielectric inertial plane after it has been electrified in the creation of this new magnet?'

The reason for this dielectric inertial self-centering is due to the conjugate magnetism resultant from electrification which causes dielectric capacitance in the iron or iron compound which thereby expels a polarized Ether phenomena that begins deceleration-reciprocation at the spatial boundary (centrifugally) of the physical magnet. This inverse spatial-counterspatial conjugation (never one without the other as is the case of all forms of magnetism) centers (rather concentrates, since the incommensurability of the dielectric is at every 'point' along the "magnet") in phase the dielectric inertial plane at the physical centerline of the magnet as pressure and field conjugations are always lowest-pressure seeking 'mechanisms'. In cannot exist any other way, logically, electro-geometrically, and likewise this is evidenced from both experimentation which is undeniable by any, however explanations are lacking by all, until now.

The dielectric inertial plane is incommensurate within ANY and ALL magnets, as any child can prove in cutting a magnet along the dielectric plane a trillion times (if it was possible) you will have a trillion more magnets with CW and CCW spin on either side and in the middle between the two a dielectric inertial plane, a "Bloch wall" in incorrect parlance. However in cutting a magnet even once perpendicular to the inertial plane you will not have moved the inertial plane, only bifurcated it in division (not actual division) between two new masses.

As is typical (mentioned below in instances) of humanity, we are looking at magnetism upside down and backwards. The obvious point of agreement is that pre-electrification, the mass is incoherent omnidirectional and null-cancelling in the inter-atomic magneto-dielectric (however none understand this small point) volume; and that post-electrification the magnet is, or has "its domains in line", but what is in line is not magnetic (resultantly it is however, but there are no magnetic 'domains' in a magnet, only the dielectric inertia and pressures of same from electrification), rather dielectric (as proven time and again by physical magnet bifurcation and other Euclidian dissections) in-phase field acceleration (centripetal and radial) by means of amplification.

Below: Inverted real magnetism image I created of a 1.25" ring magnet on left, top down, thru a ferrocell, likewise on right, a 1" cube neodymium magnet seen edge on along the dielectric inertial plane, with, top and bottom, magnetic polarization shown as oblong white spots. Notice the obvious hypotrochoid ('spirograph-like') pattern seen at the voided center (and along the outside rim) of the ring magnet on left. This will be explained further on in great detail, along with the formula I discovered for magnetic reciprocity. Notice the straight bright blue (in this inverted image) line on the cube magnet on the right, this is the dielectric inertial plane concentrated and focused at (not located at!) the mid-point between polarization as is necessitated by the incommensurate point non-specific conjugate magneto-dielectricity in this coherent system humans incorrectly call a "magnet", which in fact is a coherent dielectric object with resultant magnetic radiation, or as Faraday called magnetism: "the dielectric field". Regards to Timm A. Vanderelli, inventor of the ferrocell: two optical-grade glass elements between which is an incredibly thin layer of ferrofluid thru which light is passed and magnetically warped to demonstrate reciprocating magnetism, both divergent and convergent.

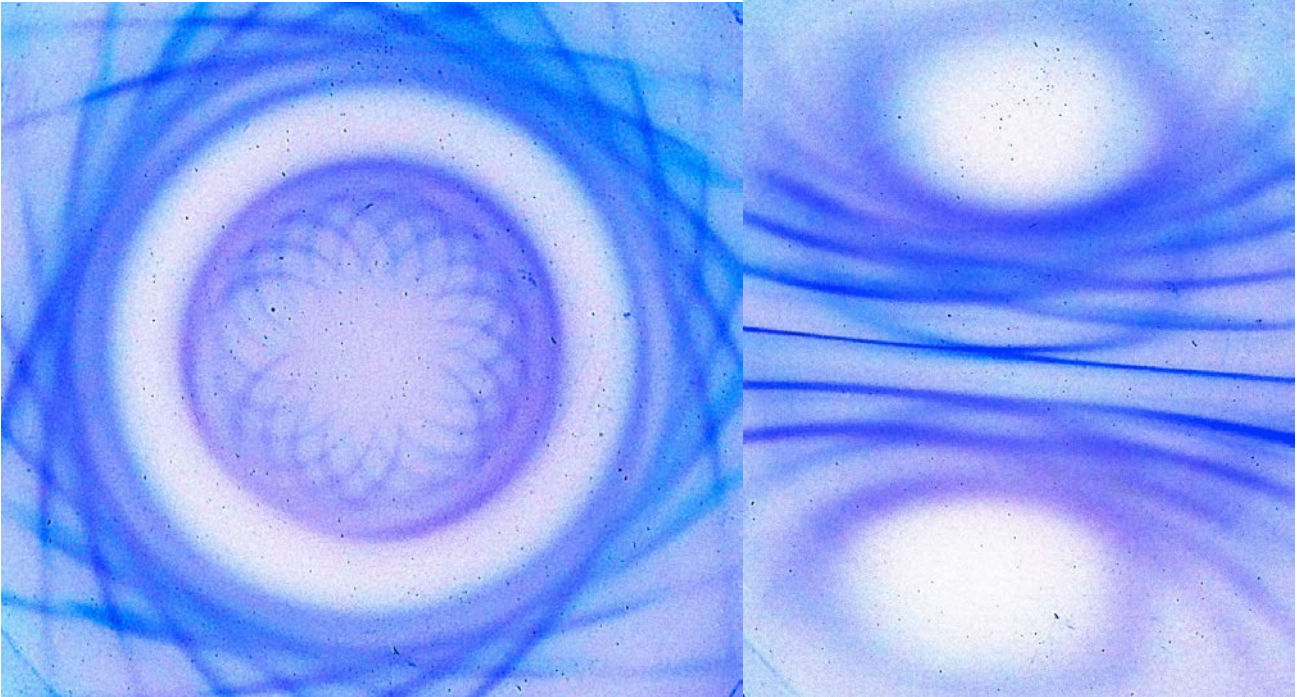

It is not the case to think that one has created in electrification, a "dielectric or magnetic laser (coherent phasing)" per-se (however analogously this is rather accurate) rather it is the case that the self-aligning incommensurability of conjugate field geometry is necessitated, logical, and cannot exist in any other manner, likewise this ordering (see further down below diagrams and explanations) is identical to AC line magneto-dielectric geometry. Seeing things incorrectly from the side of magnetism "being made coherent or aligned" in creating a "magnet" is incorrect, the resultant is accurate, but the chain of causation is utterly in error.

We might say, in a perfect analogy that taking 5 toy gyroscopes and spinning them up, before which they lay in a variegated manner with their respective axles and felly-inertial hubs/rims pointing in various directions representing the pre-'magnet' mass (however as is the case of the interatomic these 'gyroscopes' [not literally of course] of magneto-dielectric volumes are ever-moving but ARE IN inter-atomic equalization in lowest-pressure states [unless of course it's a naturally occurring loadstone]); that in spinning these gyroscopes up they will all stand on end with their respective axles all pointing in the same direction. These axles of course represent the Z-axis spatially expanding and reciprocating polarized magnetism, and the driver, the impetus for all of this, the gyroscopic flywheel, the true 'heavyweight' (in more ways than one) is the dielectric inertial plane which has been spun up (in capacitance) from electrification.

Now, in a toy gyroscope, the flywheel is attached to the axle and one spins up the axle first, however the professional larger gyroscopes are spun up by the flywheel only, which is the correct analogy of the creation of a "magnet". A magnet is not a magnet; it is a dielectric object (explained in full below) with conjugated magnetism resultantly in the chain of magneto-dielectric causation, dielectricity (in every way explained further on) is prima causa, naturally, rationally, and absolutely undeniably so, however obviously co-eternal conjugate principles resultantly in electrification; where there is one there is the other (only in the case of the permanent magnet and other AC / DC phenomena). However in the magneto-dielectric gyroscopic analogy, the axle and flywheel never meet at their intersection points. Coherent phasing in the creation of a magnet by accelerating (by capacitance) the dielectric inertial plane necessitates both dielectric and magnetic pressure gradient phasing, self-centering and circular polarized magnetic reciprocity in the electrified mass.

So how do trillions and trillions of atoms in the mass of the 'magnet' self-align their magneto-dielectric fields? The same way 5 autonomous gyroscopes having been spun up align their flywheels in perfect synchronous manners and their axles likewise; X, Y, and Z axis points between magneto-dielectricity in the creation of a magnet align by pressure gradients and dielectro-inertial gradients the same way our gyroscopes analogy lines up all three axis point vectors. The true and ONLY power in both the gyroscope model and

the model of the 'magnet' is the flywheel, which is 90% of the weight of a gyroscope, and 90% of the power in any and every "magnet" ever created. Now one begs to ask, if a magnet is 90% dielectricity, why do we call it a "magnet"? Very simple, dielectricity is counterspatial, is centripetal, is inertial and does not act on (most) other phenomena, the resultant magnetism however IS spatial, IS centrifugal (and centripetal), IS radiative, and IS polarized. Likewise children only see the puppet (magnetism) and never the puppeteer (dielectricity). There is no (almost none) power in the axle, as meant the magnetism, it is the expulsion of magnetism resultant from the cosmic model of the magneto-dielectric binding-system conjugation (see far below for diagrams and explanations).

As is the case (explained below), a true "magnet" is a dielectric object, whereas a 'magnetized' object (steel being magnetically induced) is a magnetically dominant object such that it is merely magnetically induced to temporary magnetization by attribute of its induction within the magnetic field in proximity to it; but it is not an over-pressure dielectrically capacitant object such that it is not, has not been electrified, only magnetically induced from proximal magnetization by the genuine "magnet" (dielectric dominant mass, or "magnet"). In the case of magnetization vs. electrification (true "magnet"), proximal magnetic induction aligns the dielectricity to cause phase coherency of the magnetism, but this temporary magnetization is the reactance of the dielectricity to the coherent magnetic field induction within the non-electrified iron mass. Likewise this dielectric reaction from the field induction of the genuine "magnet" causes necessitated reciprocation, or polarized magnetization to appear only so long as the field of induction from the "magnet" to the "magnetically-induced" (magnetized) iron or ferrous object, is present. Field incommensurability is inescapable; that the iron becomes magnetized resultant to magneto-dielectric pressure-gradient alignments is necessitated.

However here is where our gyroscopes analogy ends, since in the genuine model of magnetic induction, merely bringing a "dead" gyroscope in proximity to the 5 spinning gyroscopes would cause the "dead" one to spin up and align its Z-axis of magnetism likewise to the other 5, but remove it from the proximity of the other 5, and it would 'stop' immediately without any slowdown process between its pre-state and its induced-state of velocity. This is field pressure equalization. This is particle-free induction; this is magnetic induction without electrification (in the creation of a permanent "magnet"). This absolute of field induction phenomena is something Tesla understood and which is why future inventions CAN and WILL be made that can have an immediate dump of momentum without any resultant end harmonic, or resultant inertia. Imagine going from 100 to 0 without the slightest forward momentum.

Countless applications and inventions will unfold from the capacity to dump enormous field inductions in termination with zero effects. This inertial momentum of induction is mediated solely by spatial, or polarized field proximities, not inherent to the system or subject being induced, likewise induction termination in this case is non-local and therefore the effects are as well. However the inertia (forward momentum) of mass has its own field termination in which momentum can be instantly dumped with no resultant effects on the subject, from a non-local inductive source, but that is a subject for another article I will not discuss here.

Below: Left, stationary 'pre-electrification' gyroscopes with their 'magnetic' (red, axles) polarizations and 'dielectric' (blue, the flywheel of inertia) inertial planes within inter-atomic equilibrium; however in the model of the atom, our magneto-dielectric 'gyros' are ever spinning, but in equilibrium within the inter-atomic, but out of phase (in demonstrable quantities) in magneto-dielectric incommensurability in the macro because their dielectric capacitance hasn't been radically increased from electrification yet. On the right is post-electrification (the "magnet"), though all 5 are autonomous, the XYZ phase ordering in self-similar incommensurability has occurred due to inertial acceleration of the 'flywheel' (the dielectric). This amplified by many trillions of atoms creates a magneto-dielectric self-similarity of field phasing along field pressure gradients to make a singular unified whole, or "magnet" with its dielectric inertial planes and reciprocating 'axial' circulating magnetic polarization movements. The gyroscopes of course are not literal, rather a near-perfect analogy of interatomic magneto-dielectric phenomena in pre and post electrification states.

This phenomena, undeniable, I have coined as: "Field Incommensurability", or F.I. (Incommensurable: not having conjugate units of or in the same dimension, substantively immaterial and the Ether in basis. In magneto-dielectricity, one field is spatially additive, the other counterspatially multiplicative in inertial velocity). This is the magneto-dielectric binary consubstantial conjugate system inherent to all inter-atomic operations and to the pre and post-electrification in a "magnet".

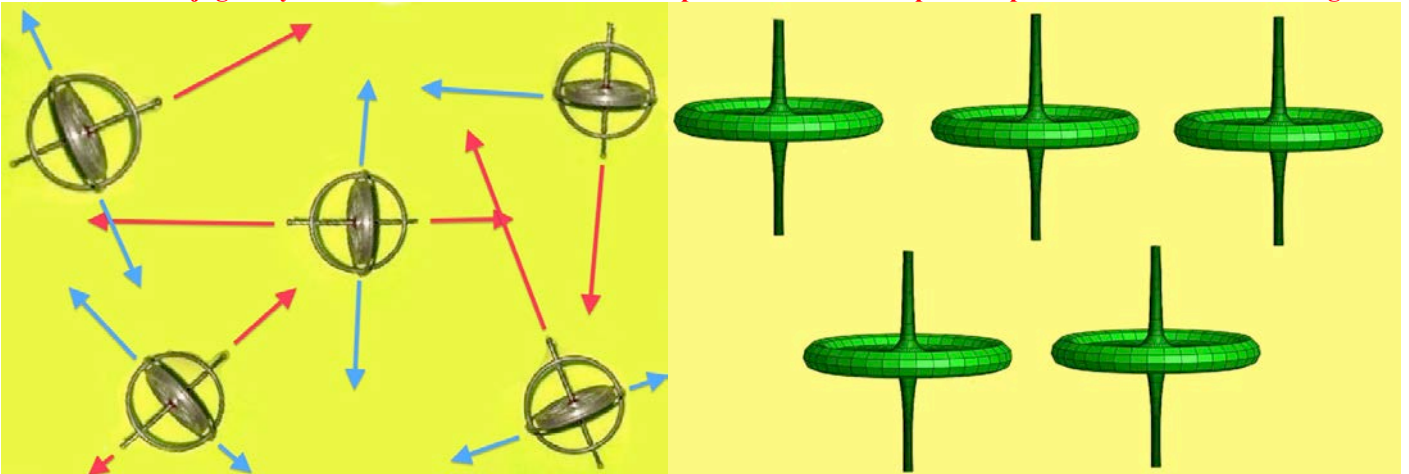

In understanding this dielectric inertial plane I have already written 20 bits of data to a magnetized subject and reproduced the results, by means I will not explain here. However the implications of this means writing data on another plane rather than merely along the XY spinning surface of a magnetic hard drive platter. Additionally I am 100% certain that data can be written between two ferromagnetic surface planes where dual platter disks can, conjugately, create data fields in the vacuum spaces between the two ferrous platters at which the data exists in a free space vacuum to be read by induction readers of conjugate magneto-dielectric field gradients. Incommensurate compounding and self-similarity likewise has implication with near-100% certainty, that data storage devices can be increased to the 100+ terabyte range in a likewise 9.5mm hard drive currently with a max capacity of 1.5 terabytes.

Attraction by a magnetic mass to a non-magnetized piece of iron is created by an Ether-vacuum vortex, which naturally tends itself towards equalization between the iron and the magnet. In presence of the Ether-magnetic field there is dielectric contraction in the unmagnetized mass which, since dielectricity is counterspatial, means there is inter-atomic dilation pertaining to magneto-attractive vacuum dilation. In shrinking the dielectricity in the atom, as it rebounds in opposition to the magnetic field, it dilates the magneto-atomic volume causing magneto-Etheric 'attraction' (via induction and towards self-voidance of polarization) to the magnet which is only a simplex pressure gradient equalization. Magnetism always seeks geometric/spatial equilibrium, as do all fields. The magneto-negative pressures created in the atomic dilation of the non-magnetized mass is being 'filled' by the field gradient of the magnet.

This is a self-seeking dielectric equilibrium however in its root. Just as two magnets of inverse spin being brought together will form a perfect spherical field before mating (which is a centripetal dielectric gravitative-like attributional inertia equalization), the iron or other ferrous mass is a pressure-equalization seeking between the "magnet" and the stable iron. The field of magnetic induction from the magnet to the iron causes acceleration of the iron TO the magnet (the dielectric-electrified mass) due to now-imbalanced field pressures in the iron. Action at a distance (all forms) are field pressure equalization-seeking sinks. Acceleration of the iron TO the magnet is resultant from creating a centripetal inertial vortex by means of magnetic induction, in the iron as flowing towards the magnet, which is both how and why iron will 'leap' to a magnet. There are no particles mediating this (as espoused by Atomists and GR and QM), only field pressures. Every gram of matter in the universe, ferrous or otherwise is sitting in its own (temporary) equilibrium, either in a gravity field, or a magnetic field, or a dielectric field. As a crude analogy, in bringing a magnet near an iron nail for example is a 'gravity field' (analogously only as meant) towards which the iron must 'fall', however this is just a negative pressure acceleration of one to the other, and the 'gravity' in this case is dielectric, as existing dominantly in the "magnet" and as conjugately induced in the inverse, magnetically, in the iron by which the iron being "magnetically induced" is merely the effect of the magnetic induction from the "magnet" causing dielectric constriction in the iron nail which thereby causes magnetic dilation in the same nail and therefore acceleration of the nail to the "magnet" which is the dielectric electrified mass with a dominant dielectric charge. Induction acceleration of the iron to the permanent (or electromagnet) is purely field alignment by means of F.I. (field incommensurability), within which all pressures are necessitated to follow field gradient parameters of self-similarity.

The "magnet" is out of equilibrium, in short, with a strong dielectric charge, and resultantly to this a strong magnetic attribute to the so-called "magnet"; as such the magnetic Ether 'bubble' creates magneto-dielectric pressure imbalances in other sympathetic ferrous structures (and non-ferrous at greater powers) materials which force their acceleration towards those objects out of equilibrium. Nobody understands that all matter is a balance of field pressure gradients, and throwing one object greatly out of balance, even if stable, due to iron's magneto-dielectric 'elasticity' is but one very lucid example, with an extremely unclear understanding by most peoples. This conjugate causation is not understood by modern science, however science is certain it understands magnetic induction, however only very superficially so at best (and unfortunately with materialistic insane explanations). This at-rest acceleration of the iron towards the magnet is of course due to magnetic induction, but is sourced firstly in the dielectric, and of course all fields are Ether in nature; as such an Ether vacuum sink (field incommensurability) is created between the magnet and the nail which forces acceleration of the later towards the former. All matter has its decelerant, and likewise has an accelerant. Dielectric, magnetic, gravitational, centripetal or spatial or counterspatial. Conjugate perfection exists in nature, one spatial, the other counterspatial, at which pressure gradients dance around a fulcrum of action-reaction.

As is the case between the "magnet" and the nail when 'together', whereas the nail is magnetized (magnetically induced), the "magnet" is dielectrically saturated from electrification. Inverse to general understanding, the non-"magnet" nail is the magnetic object (temporarily) and that which we call the "magnet" is in fact the dielectric object with secondary attributional magnetism as a resultant from the process in its creation.

Magnetism does not operate by centrifugal movement alone because, while magnetism is definitionally polarized, it moves as pressure dictates it must; its centripetal movement is governed by dielectric inertial pressures of the Ether in self-seeking equilibrium out of space and time back to the counterspatial. Counterspace definitionally is the 0-point fulcrum from which all fields are manifest, either attributionally as polarized in magnetism, or centripetally and radially as in dielectricity, or in stable formats as matter itself.

Non-contact electrification in creation between a spatially polarized Ether field (magnetism) and a centripetal magnetic barrier (dielectric reflector) is the counterspatial torque from the inertial plane of which 0-point dielectric precession is caused to torque in creating electricity perpendicular to the precessional inertial perturbations as forced from repeating magnetic deflections over a given time. This is the Planck in creation. One prime mover must overpower the prime inertia for electrification to occur. That prime inertia is counterspace, is the dielectric inertial plane, or membrane for field phenomena to manifest and interact.

Below: Cross sectional side view of a magnet, its dielectric plane, with centrifugal and centripetal circular polarization.

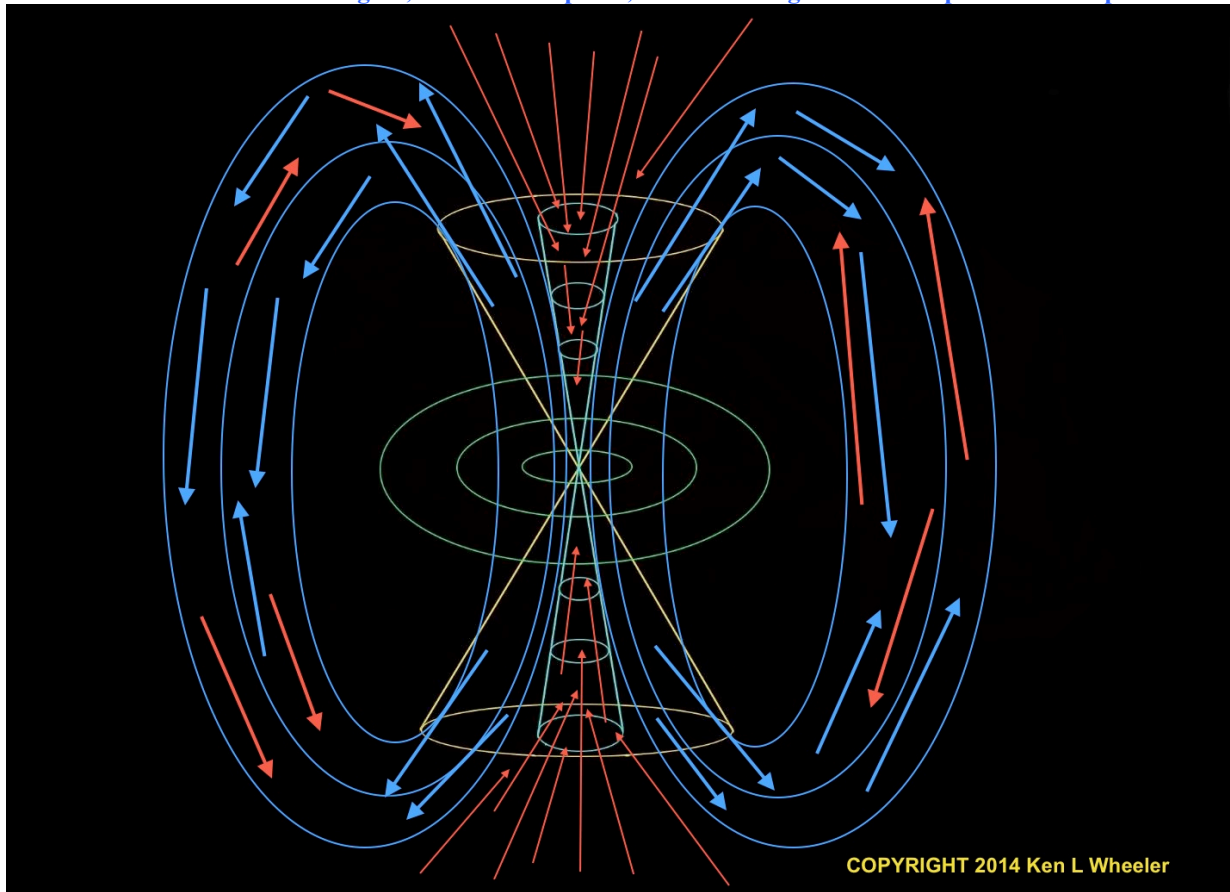

It is said that space or nature “abhors a vacuum” but this is untrue, it is the Ether that abhors a vacuum of itself; micro-magnetic, as meant atomic dilation is filled by the magnetic, or Ether-field, there is no void inside the atom as GR and QM profess. There is no Ether in space, only space; counterspace is the opposite of space. Ether disturbances can be brought into space, such as magnetism, mass, gravity, electricity, dielectricity, but all lines of force terminate in counterspace, not in space, as such Ether terminates in Ether. That polarized spatial Ether fields exist is, as always can be found, against-space, not in space. A spatial disturbance is really an Ether field disturbance, either radial, polarized / circular, longitudinal, centrifugal or centripetal. Space has only 1 dimension, space; fields interact with other fields in different modalities of pressure stability.

All atomic bindings are Ether and Ether equalizes itself with itself, conjugately by dielectricity or by magnetism in the counterspatial and in the spatial, or in dynamic polarization by the production of electricity. To speak conventionally as humans are necessitated, we say magnetism is spatial, however this is empirically just a connotation, what we are denoting is that a field is polarized (rather distended as space, not against space or ‘in’ space, since this is impossible) against itself (from another causation namely dielectricity), but not OF space. As mentioned, polarization is a trick of space in seeing CW on one end (in space) and CCW from the other end (in space). There is space in Ether when the Ether is in dynamic movements, centripetal or centrifugal, radial or circular, but the Ether is not in space, the Ether is only in itself as it equalizes itself with, by, in and thru itself with itself, the space created from this dynamic is merely an attributional convention. As is the case, there is ‘gold in the gold lion, but no lion in the gold’.

Any polarization of the Ether must be dielectro-electromagnetic, dielectrically terminating (as mass), or magnetic by definition. Electrostatics, longitudinal and dielectricity being counterspatial and without polarity cannot partake of polarity and likewise also not partake of space or time. Spatial accumulation of mass however is a different modality with a centripetal field, but a spatial accumulation of matter.

Below: True view of magnetism divergence and convergence, centrifugal and centripetal. Likewise that which drives and is the Ether modality behind all magnetism, dielectricity. Magnetism is the 'dielectric field', is dielectricity in discharge, the radiation of same. A 'magnet' in a manner of speaking is a short circuit of coherent dielectric point non-specific self-similarity; in perfect magneto-dielectric field conjugation, as created from increased capacitance or coherent induction from another source without an increase in dielectric capacitance.

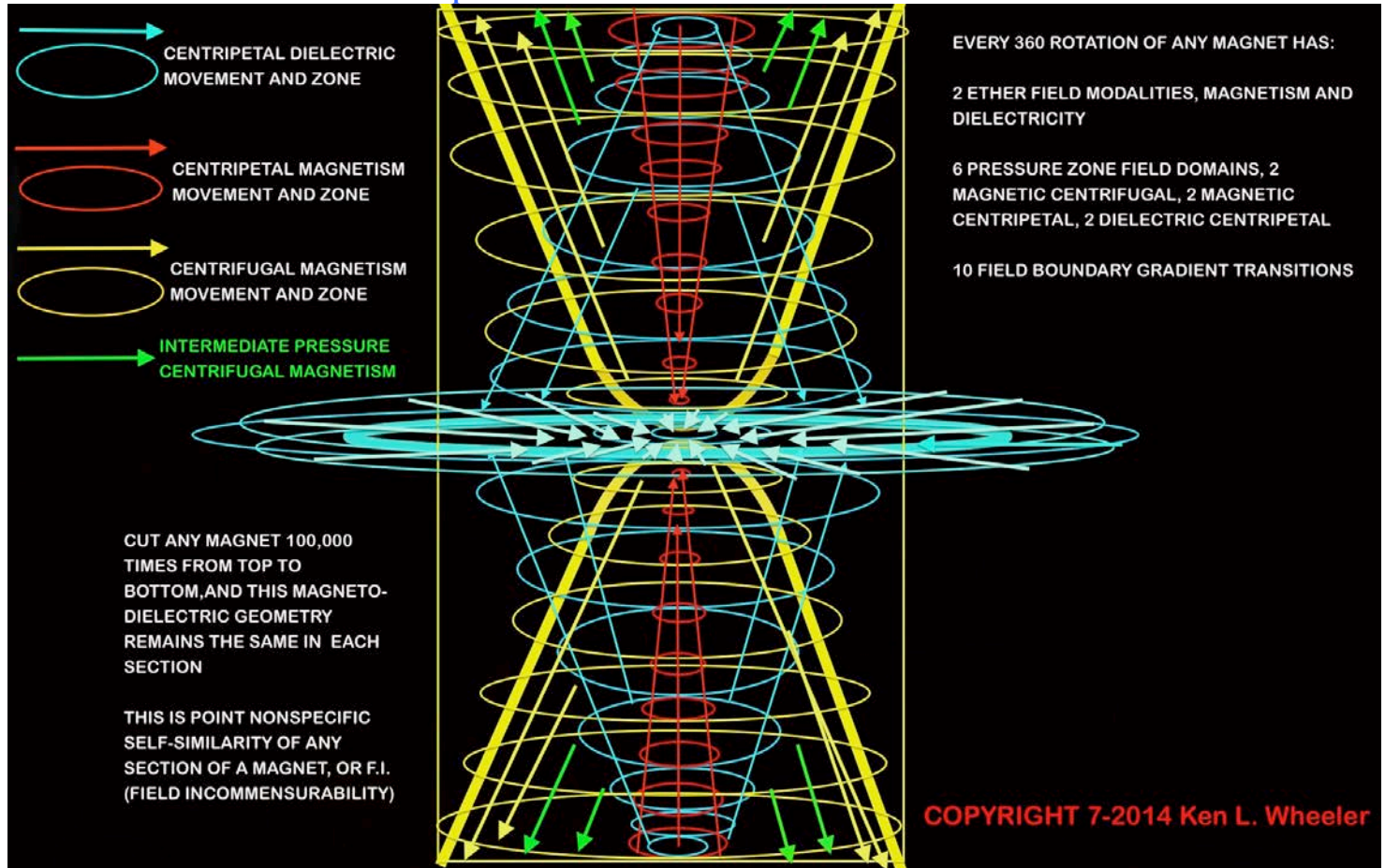

A magnet is an electrified piece of iron into which a strong generative dielectric current has been caused to circulate such that the trillions of atomic pumps, which make up the magnet have been manipulated. The electrification is so great that the magnetic outflow is like a speeding rapid in comparison with its normal flow. The axial poles of rotation and the magnetic poles have become almost superimposed, the potential and unit pressures gradients have been amplified to such an extent that another piece of iron of normal (equalized) potentials and pressures are drawn into the higher pressure of the "magnetized" iron, and its potential also raised, i.e. magnetic induction.

Below: Magnetic putty and a 1cm cubed neodymium magnet. The magnet (rather the dielectric) will self-center itself in the middle of the mass of putty, regardless of shape or size. Once entering the putty, the putty will form a sphere around the magnet, regardless of the shape of the magnet (of course). Amusingly, it slowly looks like the putty is inhaling the magnet like a creature eating an object, however it is the case that the "magnet" is self-centering the magnetic induction fields in and of the putty which is a viscous ferro-magnetic suspension.



There is no attraction vs. repulsion in a magnetic field, all so-called attraction is driven by the dielectric, only the spin of the circulatory field planes of the magnetism. Positive charge attracts positive charge and expels negative discharge in an electrified magnet. Negative discharges repels both negative discharges and positive charges. **The fact that dielectricity expels magnetism does not mean that it repels it.** The expulsion of magnetism is not the repulsion of magnetism. This is the magneto-dielectricity of conjugate field incommensurability.

The product of magnetism united with dielectricity gives rise to the total electrification of the Ether. Psi times Phi = electrification. ($\Psi \times \Phi = Q$); meaning that electrification gives rise to dielectric saturation of the atomic geometry, and strains the Ether in a “magnet” due to the magneto-dielectric atomic ‘elasticity’ or malleability of iron. Dielectric and electric charges give rise to (increased) magnetism. The inverse of electrification is utter voidance, as terminated into magnetism, pure polarized radiation. Electricity terminates in magnetism, as a polarized radiation, but terminates in same only thru the dielectric. All appearances of magnetism as terminating from electricity, has a dielectric locus or intermediary causative agent in principal, in the atomic, in a “magnet”, or even in a galactic jet.

Below: Top down view of magnetic velocity on a cylinder magnet.

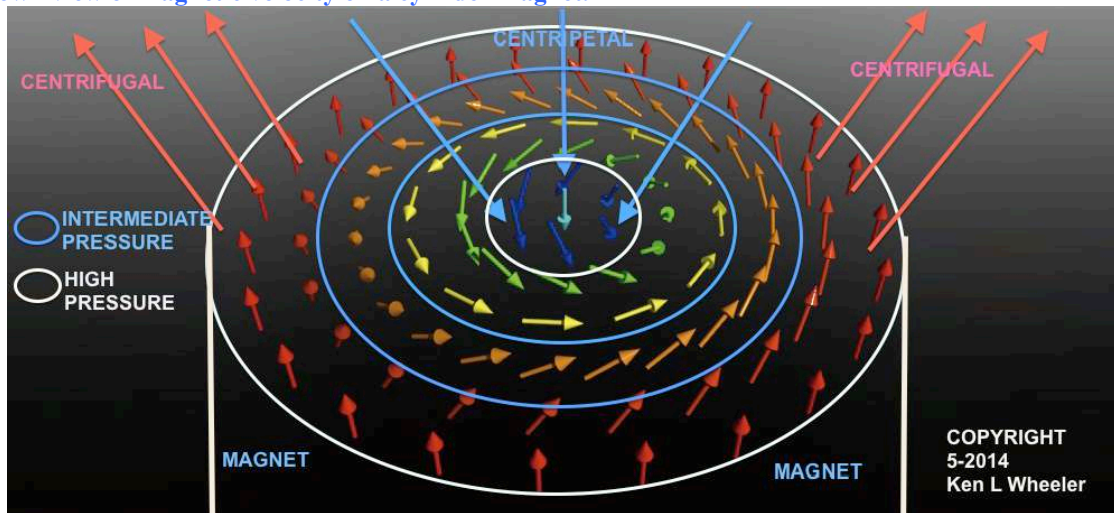

Expulsion is the result of electric attraction which causes the electrically charged counterspatial dielectric to draw closer together and distort the micro-magnetic atomic geometry out of equilibrium. This effect of closer assemblage is a centripetal effect of contraction which squeezes magnetism away from the spaces between the integrating particles of electric preponderance. A high charge = high sink/bubble vortex (in discharge) of magnetism. A high magnetism in motion over time = charge as against a dielectric conductor, as meant a magnetic reflector.

A dielectric reflector (deflects magnetism, but in stress from precessional magnetic movements is caused to create radial electrification) is the very same which conducts the dielectricity around which the electromagnetism reciprocates. Electricity and circular magnetism exists radially around and down between the AC conducting lines, but the radial dielectric exists radially thru the dielectric conductor (magnetic reflector. A reflector which is dominantly dielectric [silver, copper, etc.] or as meant a magnetic reflector which causes dielectric precession, or torque) operates centripetally, (in attraction) between the lines.

A reflector material, or element which is dominantly dielectric is a magnetic reflector. The ‘dielectric reflector’ nature of the dielectric medium is its resistance to magnetism and likewise production of electrification, by its precessional dielectric torque resultant from magnetic fields against same over time. The prime mover of the magnetic field, over time, induces precession against the dielectric medium, in its inertial plane torque, to induce electrical phenomena. It must be understood that the “dielectric reflector” isn’t meant that it is reflecting dielectricity, rather reflecting against magnetism by nature of it being dielectric in medium, such that it should be called a reflector of a dielectric medium which reflects (resists) magnetic field movements.

Below: A more elaborate view of dielectric and magnetic field dynamics of a so-called “magnet” which is, in reality, a dielectric coherent object. “Aligned domains” is a misnomer, the truth of the matter is that magnetism is a resultant of coherent inter-atomic dielectricity aligned to yield resultant polarized magnetic reciprocations.

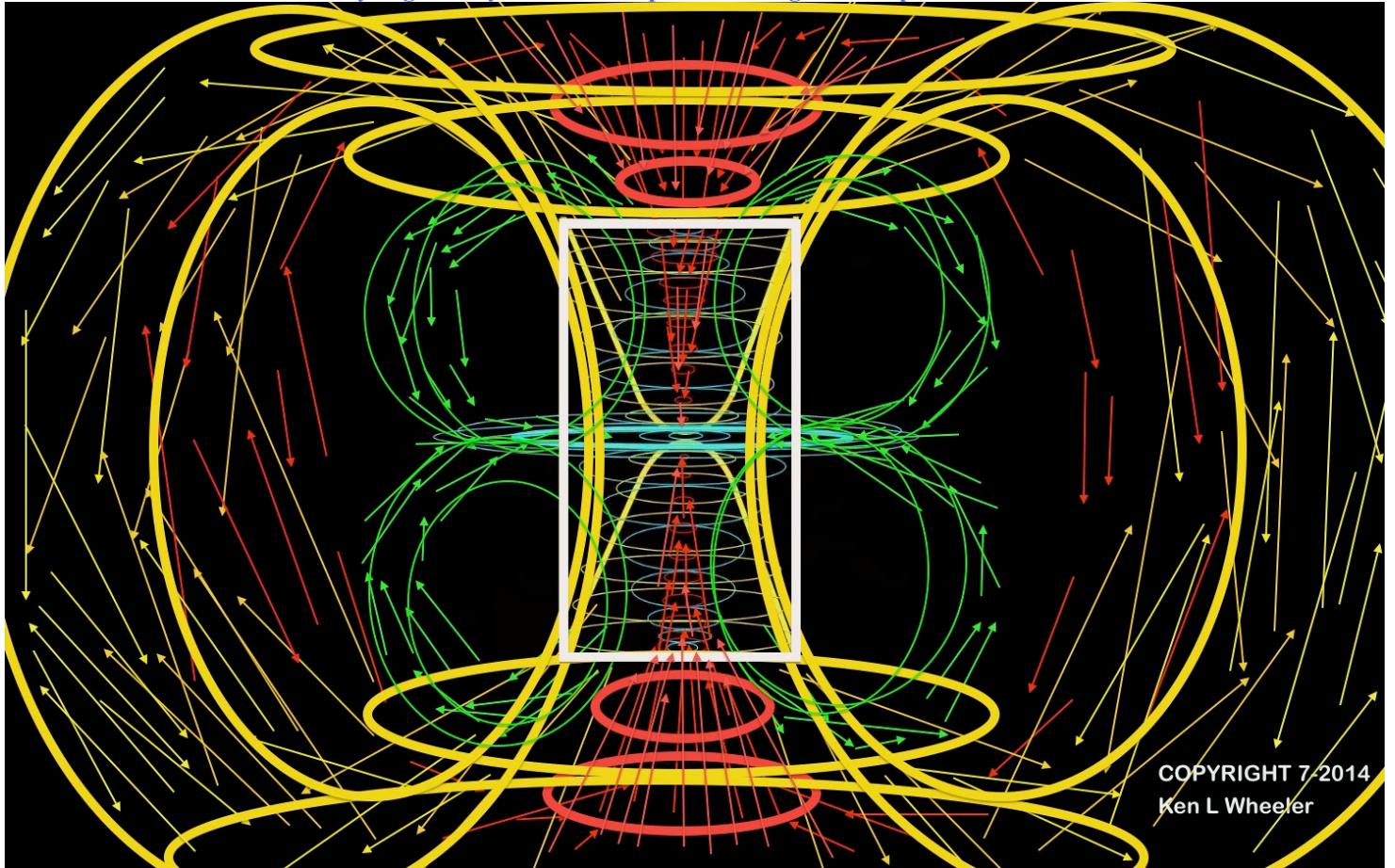

The only difference between AC lines and TEM (dielectro-electromagnetism) is that in AC current the electricity is flowing radially at the intersection of the dielectric and magnetic between the lines, whereas in TEM, where there is no Z-axis physical conductor, the magnetism and electricity are reciprocating along the XY-axis as thru and against the Z-axis radial dielectric element of TEM.

Below: showing mutual fields views of magnetism and dielectricity as separated out showing necessitated pressure conjugation. These will shift at breaks, or if a magnet were to be sliced against its dielectric inertial plane. All magnets have point non-specific self-similarity at every portion or part of the "magnet". This is the Wheeler Principle of magnetic field incommensurability. Absolute grasp of this principle is necessary for any understanding of how a magnet works to occur.

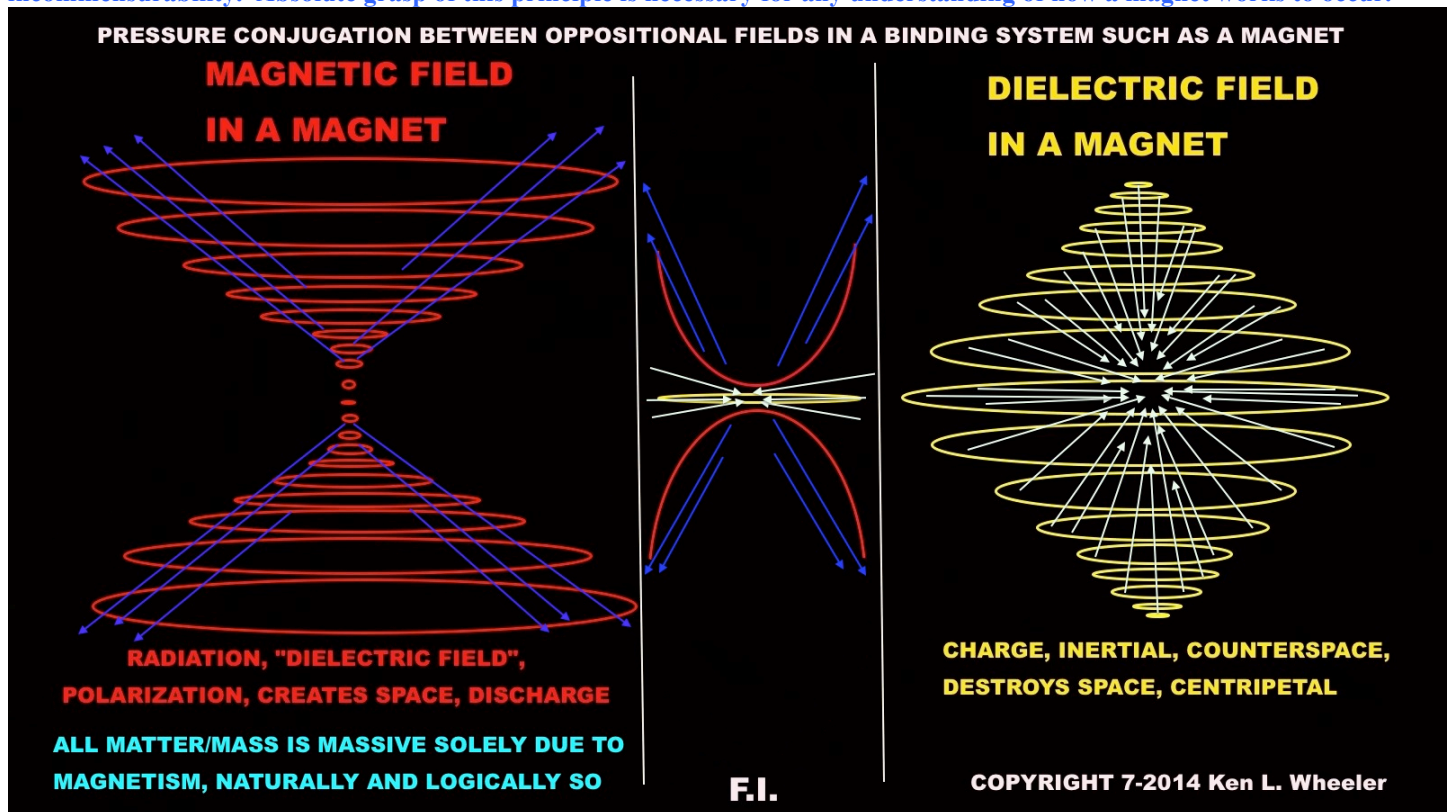

The dielectric inertial plane has its null-axle or fulcrum in the space between the AC lines and its inertia plane radius is running radial thru and down the both AC lines, whereas in TEM the dielectric is running radially along the Z-axis with both its inertial plane and axle in superimposition however pulsed radially in distention and contraction as electromagnetism reciprocates around and against the Z-axis dielectric. Counterspatial capacitance without a physical conductor is nature's perfect XYZ spatial-counterspatial geometry of TEM; here is wireless transmission of immense power, nature's way.

Below: AC transmission lines, looking end-on. In simplex, when magnetism is the expanding Z-axis spatial 'axle' the dielectric inertial plane is distended as the disk; and when dielectricity is the Z-axis radial, then magnetism becomes the XY-axis circular spatial reciprocating torus, or 'disk'. At no time however is the dielectric circular, only radial and seeking the smallest space. This is the premise of dielectricity being generative and magnetism being radiative, terminal. Far right is an AC circuit.

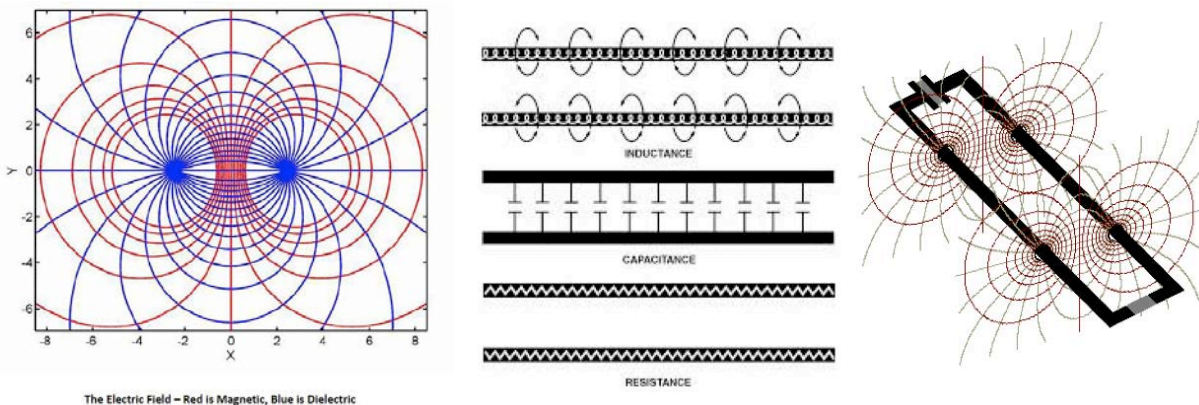

The never before understood reason that higher gauss rated permanent magnets have a much more shallow field geometry yet higher gauss ratings is due to the logical fact that the Ether vortex velocity is higher in conjunction with the higher gauss ratings. As any vortex climbs in spiral velocity its radius decreases in step. This is the very same reason why extremely highly gaussed stacked magnets which come to an apex, while having high gauss readings up to 1.5+ Tesla; these same fields are extremely shallow and do not extend beyond the surface more than a fraction of a centimeter. Field ratings fall off at distance in direct proportional relation to

the vortex Ether velocities of the magnet. Since the magnetic field is a double reciprocating vortex, the higher the apex velocities due to higher gauss rating, likewise the more shallow the cone is allowed to extend from the magnets surface. This conjugated reversion causes significant shortening of both vertical axial lengths of the N and S vortex.

The coherency of the charge coupled with the macro-magnetic electrification of the ferrous mass at the atomic level has created a permanent Ether-vortex of magnetism, a sink-bubble phenomena that will, under ideal circumstances, last nearly in perpetuity under ideal conditions.

The negative terminals, as meant the discharge-planes or dielectric are counterspatial and terminate into spatial magnetic phenomena; in magnetization there is inter-atomic nuclear-charge and discharge-plane contraction from the increased electrostatic capacitance (dielectric) and expulsion of the magnetic. Dielectric saturation causes magnetism to increase, as the two are mutually repellant conjugates and both approach higher spatial and counterspatial inductances.

Below: Relative mutual magnetic field reciprocation on any magnet. Distinction must be made between inside to outside polarization, versus face-down polarization, also all movements are relative to the other poles mutual divergence and convergence.

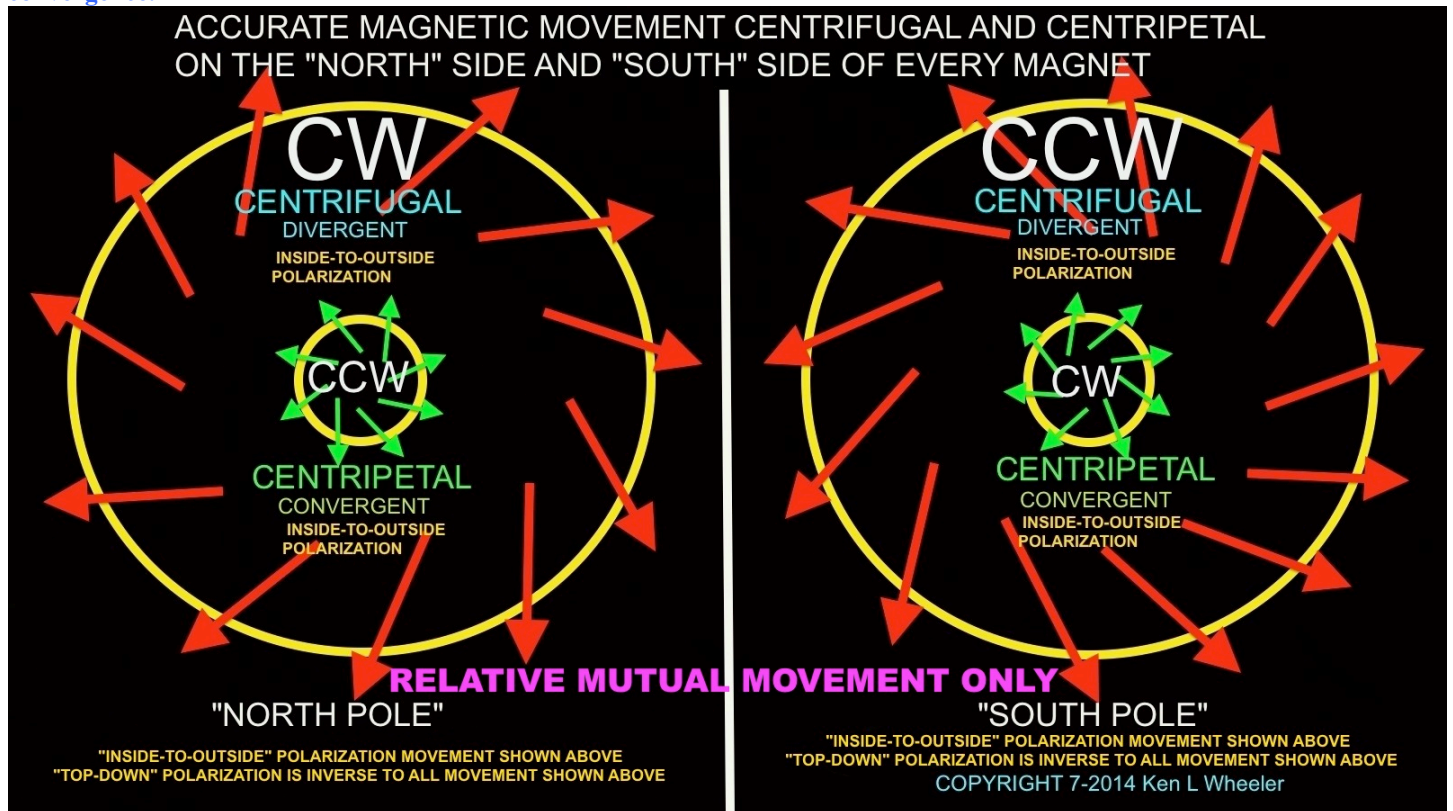

Dielectricity is counterspatial and magnetism is spatial, one counterspatial electrostatic, and magnetism circular, spatial and polarized. Electric discharges terminate into the polarized magnetic spatial by way of a dielectric locus. Charge polarization or field polarization movements of and between space and time is the fulcrum of ever balancing equilibrium in which the cosmos functions.

Wherever there is one, it is due to the appearance of the other, magnetism is induced into existence, or inversely, the dielectric is induced into existence by magnetism over time from a prime mover. However to induce dielectricity requires a polarized field to move its polarization or separate its polarization over time from a prior prime mover; but to induce magnetism into existence, electricity must merely terminate into a dielectric inter-atomic medium, or locus.

Depending on the atomic and spatial geometry, electrical discharges (Ether polarization) can terminate (discharge) in counterspatial dielectric capacitance or terminate (discharge) in spatial magnetic inductance. The charge-plane (nucleus) of electricity and magnetism are spatial such that both are polarizations of the Ether and have dimensionality and a gravitative component with its locus in the dielectric. Not mentioned here are some of Tesla's dielectric longitudinal waves that do not have a conjugate magnetic component.

That the dielectric terminal in counterspace is necessitated to be capacitance and that magnetism's terminal of space is necessitated to be polarized inductive motion are self-reinforcing definitional absolutes, such that any discharge into a spatial medium terminal must be both polarized Ether movement and magnetic induction by definition and any discharge into a dielectric medium of counterspace

itself must be both capacitance and create a counterspatial dielectric momentum and tend towards spatial contraction as is the nature of dielectricity to be multiplicative in –space and magnetism to be naturally additive in +time.

Magnetism is additive in +time and multiplicative in + space, and dielectricity additive in –time (no-time, not reverse time), and multiplicative in –space (counterspace).

Below: Each end of the magneto-dielectric hyperboloid, or polarized pole (N and S) has inverse relative (emphasis!) divergence (convergence) and likewise inverse relative (emphasis!) convergence (centripetal). All divergent and convergent reciprocations and likewise gyromagnetic precessions naturally follow golden ratio proportionality both in whole and in part.

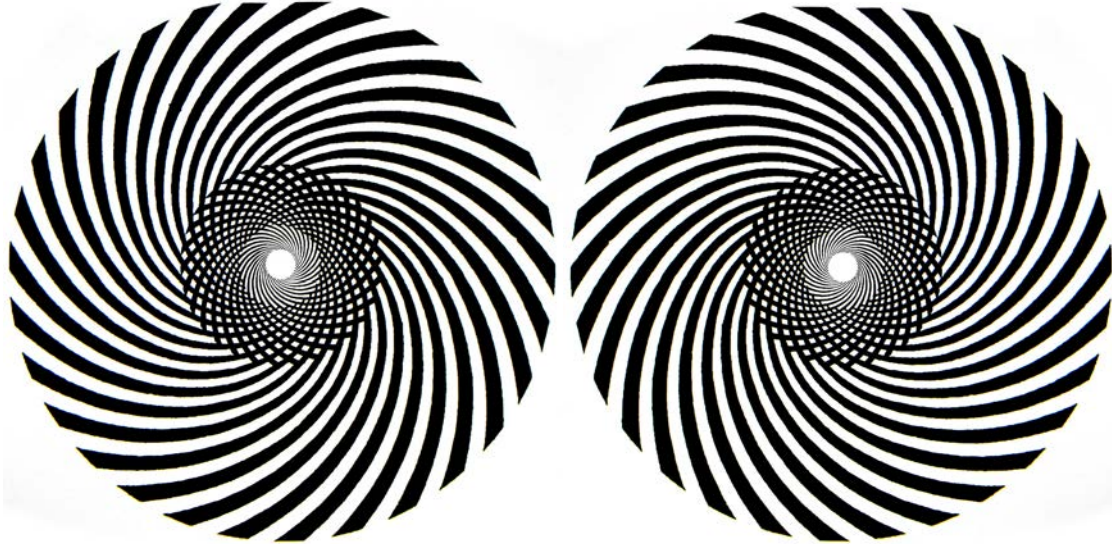

Magnetism's discharging plane (over time and space as moved or self-reciprocating) is counterspatial. Magnetism's inductive charging plane is voluminous, is spatial. Dielectricity's discharging plane is spatial, is degenerative in increasing volume. Dielectricity's charging plane is counterspatial, is accumulatively greater in decreasing spatial volume. Spatial movements are of a discharging and charging nature; magnetism is degenerative, is radiative and the expulsion of electricity and dielectric discharges spatially. Electricity discharges or terminates into the magnetic plane by way of the dielectric. Electrification is formed out of the dielectric counterspatial and magnetic spatial planes. Magnetism is literally the polarized spatial 'breaks' upon which the universe is self-regulating.

Anytime throughout this work I make a reference to "in space" or polarized "in space", this is merely a convention of speaking, since all fields are not IN space, rather there is space within a field, but not the inverse.

Every appearance of magnetism in the macro, or extra-atomic volume, has a reactive recoil wrongly conceived of as a conjugated pole, however this is not the case as the dipole nature of magnetism is a spatial abstraction. Its appearance is both an action and recoil from the inter-atomic counterspatial dielectric capacitance resultant from a magnets creation in electrification of a ferrous or quasi-ferrous (neodymium composite or otherwise) mass.

Graphite over S will be thrown off CCW, and CW off the N, however in any movement over the end planes ('poles') surface of the magnet with cause the graphite to be spun opposite the movement of travel such that the vortex CW or CCW is still a magnetic vortex and the graphite is diamagnetic in its supra-dielectric nature to be magnetically repulsed in any movement contrary to the direction of travel.

Pyrolytic graphite is diamagnetic, as means is supra-dielectric in its nature to be magnetically repulsed In any movement contrary to the direction of travel; always inverse to the movement of the graphite piece but always free to be tossed CW off the 'North' and CCW off the 'South'. However of course CW and CCW are conventions of the reification of spatial abstractions that are reified unrealities.

Gauss ratings on magnets are a complete misnomer. Gauss is a measure of magnetic vortex velocities, and not a false abstraction in wrong definition of a concrete localized dimension of its power, however this velocity or magnetomotive force is in place as pertains to magnetic flow velocity induction. Geometric manipulation of a magnets mass from that of a cube into a cone will greatly increase the vortex acceleration at the apex of the cone magnet however likewise the field depth will be greatly diminished. Golden ratio proportionality between field velocity and geometry must be maintained. Magnetic flux density or induction are misnomers for the pressure equalization velocities along magnetic fields as they equalize proportional to the geometry of the magneto-dielectric mass, or "magnet", the levels of dielectric capacitance they have been charged with and the stability of structure in its manufacture. In the case

of a cone magnet, this creates a dielectric axial torque, which narrows the magnetic field window at the distorted centrifugal and centripetal point of reciprocation at both the apex and base of the cone magnet.

James Clerk Maxwell's "idle wheel" analogy

Below: I only recently came across J.C. Maxwell's vortex analogy and 'idler gear' comparison, which mirrored mine, except J.C. Maxwell did not grasp that, unlike a mechanical idler gear which plays only a passive-effective interactive part in movement, the **dielectric inertial plane, or 'idler' gear is the actual mover, the driver, so to speak.** As is necessarily, logically, and absolutely the case to which dielectricity is by nature, being inertial, counterspatial, and creating magnetism as an Ether-modality in the discharge of itself. Also unfortunately J.C. Maxwell, while a strong supporter of the Ether, makes an Atomistic comparison of the "idler" gear of vortex reciprocation.

The second step in constructing the model was to find a mechanical analogy to electrical current which would connect electrical current and magnetism. Maxwell's ingenious solution was the supposition that electricity consists of small balls separating the magnetic vortices, the vortices being regarded as flexible bars with rough surfaces. Maxwell explained the problem and his solution thus:³

Assuming that our explanation of the lines of force by molecular vortices is correct, why does a particular distribution of vortices indicate an electric current? A satisfactory answer to this question would lead us a long way towards that of a very important one, 'What is an electric current?'

I have found great difficulty in conceiving of the existence of vortices in a medium, side by side, revolving in the same direction about parallel axes. The contiguous portions of consecutive vortices must be moving in opposite directions; and it is difficult to understand how the motion of a part of the medium can coexist with, and even produce, an opposite motion of a part in contact with it.

The only conception which has at all aided me in conceiving of this kind of motion is that of the vortices being separated by a layer of particles, revolving each on its own axis in the opposite direction to that of the vortices, so that the contiguous surfaces of the particles and the vortices have the same motion.

In mechanism, when two wheels are intended to revolve in the same direction, a wheel is placed between them so as to be in gear with both, and this wheel is called an 'idle wheel'. The hypothesis about the vortices which I have to suggest is that a layer of particles, acting as idle wheels, is interposed between each vortex and the next, so that each vortex has a tendency to make the neighbouring vortices revolve in the same direction with itself.

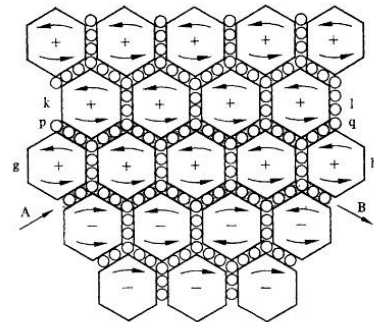
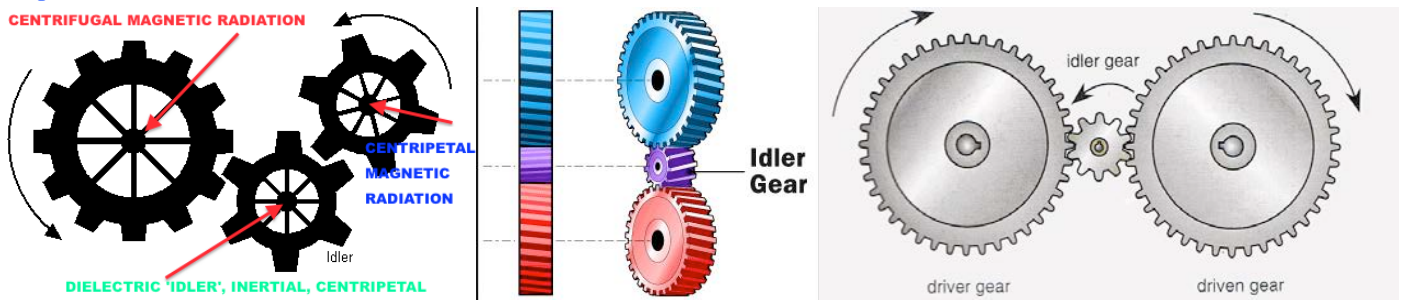

FIGURE 17

In mechanism, the idle wheel is generally made to rotate about a *fixed* axle; but in epicyclic trains and other contrivances, as, for instance, in Siemens' governor for steam-engines, we find idle wheels whose centres are capable of motion. In all these cases motion of the centre is half the sum of the motions of the circumferences of the wheels between which it is placed. Let us examine the relations which must subsist between the motions of our vortices and those of the layer of particles interposed as idle wheels between them.

Below: On left redrawn correct (crude analogy) premise of dielectricity as the inertial driver (inverse to mechanical 'idler' gears). Middle and right are mechanical idle gears which mediation a passive-interactive role in movement and mechanical reciprocations.



Below: My discovery and formula for magnetic reciprocity given a perfect situation. To add to J.C. Maxwell's analogy, as I have discovered, that unlike machines, the "idler wheel" of what is 'driving magnetism' is the stationary inertial dielectric which is the prima causa, the Prime Mover of magnetic reciprocations; **just the inverse to a mechanical 'idler gear'**. This is the fundamental nature of dielectricity being the 'electrical inertia', and fundamental Ether-modality from which the other 3 are derived.

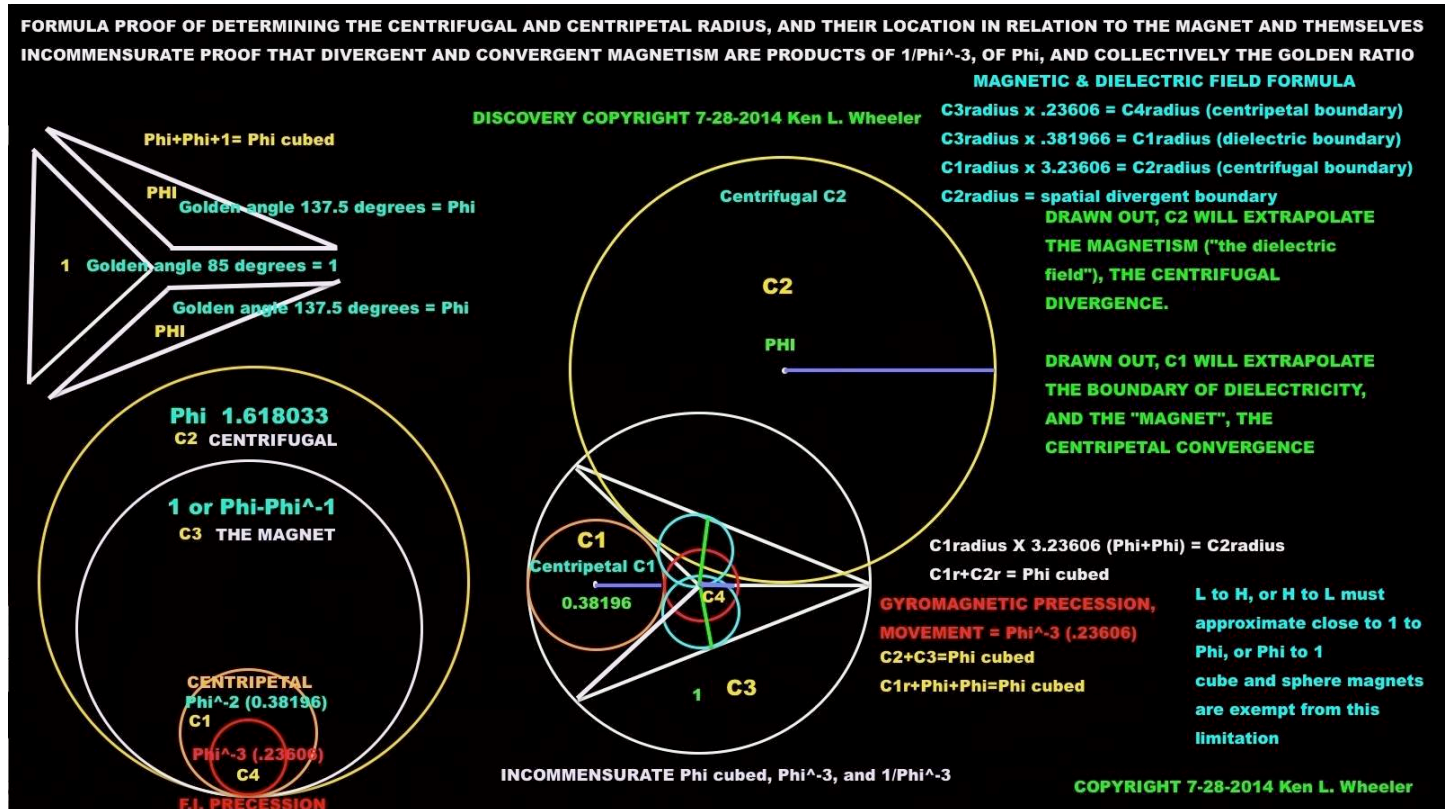

Magnetism is the spatial 'recoil' of electricity in termination, but is not the conjugate of electricity as conceived predominately as 'electromagnetism'. Electricity's conjugate is the discharging plane in the magneto-dielectric inter-atomic, not magnetism directly, which is where electricity terminates, but not its conjugate. While electromagnetism is paired with magnetism in the model of TEM, this is not an indictment that magnetism is the conjugate to electricity, dielectricity is the conjugate of magnetism as co-eternal principles and the mediator for electrification and the medium for electrifications termination into, or as the Ether-modality we call magnetism.

There is neither a South nor a North Pole as regards a magnet. A magnet is only 'polarized' in the true sense that its expulsion from the magneto-dielectric sphere necessitates the creation of a circumferentially compressed sphere which is a dumbbell shaped hourglass of macromagnetic preponderance which turns CCW on the one end 'south' and CW on the other end 'north'. However the entire magnetic hourglass is rotating centrifugally in the same direction only inversely so as seen from either end. Both 'ends' are self-seeking the lowest Ether gradient to sink and return to circumstantial equilibrium (see Moire' patters further on), either along the midway points between center and edge of either ends of the polar surface where they will trace to the Bloch wall (dielectric inertial plane) or from higher ejected velocities around the edge-circumferences to the 'pole' at 180 degrees to the CW or CCW vacuum point to which CW is a vacuum point to CCW and CCW is a vacuum to CW rotation. However even 'vacuum' is a convention, what is really occurring is the voidance of polarity in the fulcrum of null dominance over high-pressure velocities seeking utter voidance.

Below: Left, standard bar magnet with iron dust, middle two inverse spin fields accelerating towards a forming dielectric-gravitative center. Far right are two likewise spin fields causing deflection; this is mirror membrane Ether deflection, this is literally extremely high-pressure space, whereas the middle picture is a negative pressure counterspatial voidance sink. Since the center picture is diagramming the Ether returning to counterspace, that picture is showing the formation of the new dielectric inertial plane between two inverse spin fields and two separate magnets about to become one single magnet.

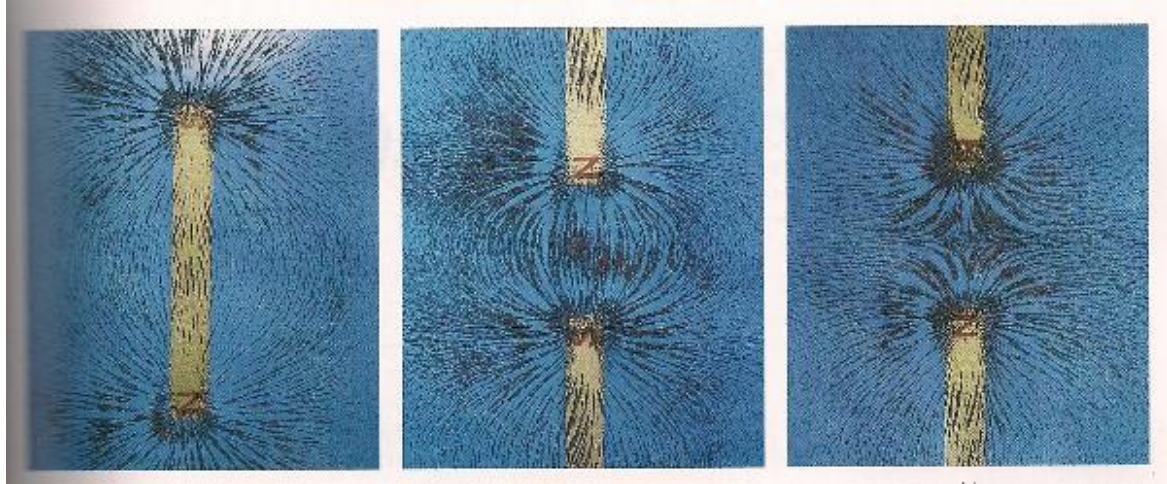

The reason false-field-lines (iron filings) trace spheres between N to S or S to N in ‘attraction’ rather than perfect parallel lines is because the vacuum seeking equilibrium must trace itself CW to the CCW or CCW to the CW to the Bloch wall (dielectric inertial plane) of the lowest preponderance of Ether pressure, however given the nature of a permanent magnet this cycle must be repeated endlessly. Direct parallel lines of ‘attraction’ from N to S or S to N (rather CW or CCW, since a magnet has no poles, only inverse spatial spins of magnetism) cannot occur since the hourglass shaped Ether bubble travels centrifugally as high pressure either CCW or CW and likewise travels centripetally towards low pressures to CCW or CW directed at the null-point fulcrum of the counterspatial dielectric inertial plane. No travel from or in return can make contact and must therefore seek equilibrium by spherically corkscrewing towards each other with CCW approaching from around the sphere in one direction and CW approaching from around the sphere in the opposite direction. The ‘shrinking sphere’ of polarization voidance is then completed.

This shrinking sphere (in approach however) is sourced in the dielectric inertial plane and this cannot be missed, its importance is massive. That dielectricity terminates in mass/(and as) gravity is no coincidence. The centripetal gravitational-like sphere of two approaching magnetic fields shrinks and compresses as does dielectricity does by its very nature. As mentioned later on, a magnets ‘desire’ to self fold is enormous; dielectricity seeks its counterspatial homeostasis and CW on CW or CCW on CCW fields are polarization against a non-polarized 0-point dielectric seeking like on like for collapse as against its own created space, which is why magnets with opposite vortex movements (CW nearing CCW etc.) accelerate towards one another in bringing the dielectric into closest homeostasis, or voidance, with its counterspatial nature and capacitance equilibrium which is not spatial but counterspatial. As a side note, the “0-point energy” of fictional works has a true basis in reality, it’s the Ether, specifically the centripetal, counterspatial, radial, inertial dielectric! This was and is the ‘missing secret’ of Nikola Tesla. Tesla’s main research was in dielectricity, not electromagnetism or electricity. Remember again that 90% of the nature of a “magnet” is not magnetism, rather dielectricity as the ‘flywheel’ driving this macro-magnetic dominance which has fascinated humanity since the dawn of time.

Below: Two inverse spin examples of approaching magnets creating dielectro-gravitational-like spheres, the centerpoint at which they accelerate towards, absolutely identical to gravitational acceleration but much faster. That dielectric attraction acts identical to gravity is no coincidence. Dielectricity terminates as mass, and likewise resultant gravity (in super massive dielectric systems).

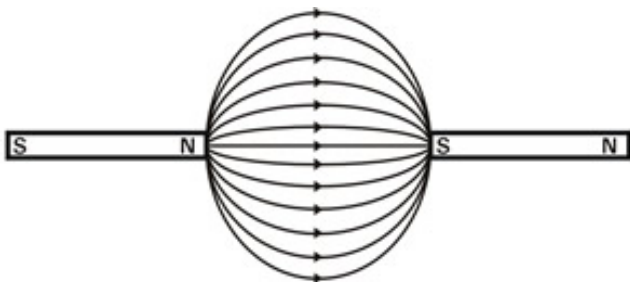

Opposite poles of magnets (N-S) attract each other.

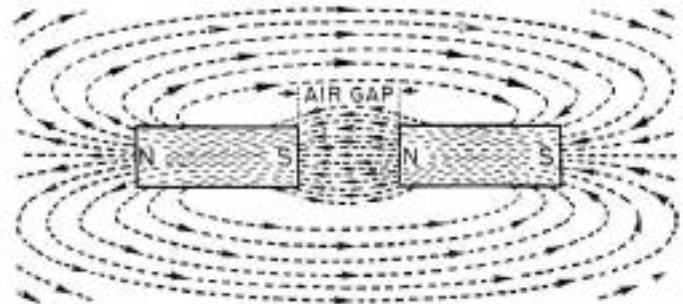

At the center of every cone and apex of a dipole a magnetic vortex is the lowest pressure gradient and vacuum point for CW to seek equilibrium and likewise for CCW, however these vacuum gradients travel centrifugally from both ends around the circumference centripetally to the center with the greatest preponderance of low pressure at the center which is why pyrolytic graphite, a supra-diamagnetic crystalline substance, will fly away from the center of any magnet which contains the greatest concentration of centripetal magnetic velocity from the equilibrium seeking pressure gradients. This is analogous to placing a piece of cork over a swiftly emptying drain however in the case of a magnet there is no spatial depression since the depression exists as a 'drain' in decreasing space towards counterspace. While magnetism is purely a spatial phenomena (as space) in circulation, its discharge is counterspatial. No lines of force of any field can terminate into space, they can however terminate into counterspace, which is one of the other main 'missing secrets' of Nikola Tesla.

It will be shown that the inversion of two fields occupying the same inter-atomic sphere when a contracting counterspatial dielectric field contracts produces a macro-magnetic hourglass or dumbbell shaped inversion in reaction to the spatial polarization (CW and CCW), or magnetic vortex. This contracting dielectric sphere against the spatially identical magnetic sphere acts as a choking constrictor upon the magnetic expulsion creating a magnetic dumbbell, a double coherent vortex whose counterspatial discharging plane is the Bloch wall (incorrect definition of science, it is the dielectric inertial plane) where spatial pressure is lowest, as achieved from around the edge of the magnet under low pressure or to the other 'pole' under accelerating returning pressures.

The zero-plane of null pressure-curvatures at the Bloch wall (dielectric inertial plane) is the rebounding point, acting like reflectors for the Ether bubble as meant the magnetic pressure CW and CCW movements. Electrification creates a micro-magnetic stricture which is coherently amplified in the magnetized mass where the illusion of polarity is magnified as reciprocating vortexes emanating from the their "poles". Equilibrium seeking Ether gradients are mistakenly deemed "magnetic lines of force", when in fact this field is a conjugating double throw double sink Ether bubble made from macromagnetic preponderances resultant from a coherent dielectric counterspatial stricture from electrification in the creation of a "magnet".

The Bloch wall (dielectric inertial plane) is the equator of a gravitational sphere, which can be seen from any field-viewing medium. The implications and meaning of this will be discussed elsewhere.

Electrification of a ferrous mass causes an extraction of the inter-atomic magnetic 'equator' into a singular coherent macro-magnetic preponderance of mirror hyperbolas but inverse in spin direction as spatially necessitated, these are a hourglass geometric form which are the maximum inverse spherical throw as impelled by inter-atomic dielectric capacitance resultant from electrification in the creation of either an electromagnet or a permanent magnet.

The centrifugal vortex at the outer edge of any magnetic is at its peak since the line of the dielectric boundary ends at the polarized surface of any magnet (since mass therein also terminates). Dielectric retardation and constriction ends. Just as any centrifugal liquid inside a cylinder is bound by the cylinder wall and accelerates upon breaking the crest of the lip of that cylinder, so too is the centrifugal magnetic vortex upon leaving the physical magnet where dielectric constraint terminates. Logically so magnetism being the conjugate to dielectricity, the epicenters of maximum velocity are inverse, the centripetal dielectric has max velocity at the center of the magnet, whereas the magnetism has its max velocity at the outside edge of the "magnet" centrifugally (dielectric electrified object), however this is inverse, magnetically, upon centripetal voidance, or return.

As an aside, the notion of the regenerative effects from a magnet are less than ideal at either pole. Rather a minimum of 3 large 2x2x1 block magnets of high power arranged radially in a semi-circle with poles going around in a semi-circle in a non-attractive arrangement (N against N or S against south. In the case of 3 block magnets it would be SN-NS-SN) fashion and the dielectric inertial planes would be extending inwards and crossing one another like 3 intersecting centripetal dielectric knives, or accretion disks. This would have the utmost tissue regenerative benefit. All life and regeneration lies along the dielectric, not the magnetic.

In the process of electrification, the magnet against the dielectric reflector causes dielectric torque pulsations upon the conductive material in the creation of electrical current. This dielectric plane manipulation is easily demonstrated in electrification of any permanent magnet where the dielectric inertial plane has been twisted against its inertial plane of equilibrium when electrified once again, post-creation.

Where maximum deceleration on the centrifugally emitted magnetic circulation meets that of the centripetally acceleration returning circulation marks the magnetic boundary.

Magnetism is almost rather literally a magneto-dielectric gyroscope in which the dilated inter-atomic dielectric 'flywheel' created in electrification is counterbalanced by the centrifugal and centripetal (polarized) Z-axial magnetic aperture, which is the accurate model of magnetism, up to a point. This highly analogous discovery by myself is not how or why I modeled magnetism accurately, but was rather discovered after the fact, as I was searching for the highest possible model of analogous demonstration for this conjugate nature of magneto-dielectricity.

Dielectricity is the Ether under torsion and torque at its inertial plane; magnetism is a spatial circular reciprocating vortex, an Etheric

pair of fountains and countersinks. Electricity is the dynamic radial or reciprocating polarization of the Ether.

N on N or S on S don't terminate within each other, since this is a positive pressure gradient on the same plane and not a vacuum or voidance pressure plane in an inverse CW on CCW movement, but this is all driven by dielectricity. Nature has no poles, only CW and CCW spin and mutually seeking pressures of equilibrium.

A magnet attracts other iron because of Ether pressure gradients being unequal in the extreme in the "magnet". This acceleration of the iron is like a stick entering a fast moving river or current.

A magnet is no different than a dipole antenna, dielectricity is the driver, and counterspatial contraction is the reflector. CW and CCW spins are the directors. Low-pressure Ether gradients are receivers-sinks. Magnetism terminates on itself but only in low pressure gradients of opposite spin vortexes.

Below: Single 3mm neodymium cube "magnet" and pure bismuth disk (highest diamagnetic element), one pole marked green, and the other black. When pushed or tilted off the bismuth, the one polarity will always spin off CW, and the other polarity always spins off CCW. There is absolute and undeniable proof (proof after proof without end) that there is inverse magnetic centrifugal divergent spin reciprocation off the polarized faces of any "magnet".



In the case of superconductors, nothing is added, only the magnetic bases have been closed off in the extremely low temperatures. The entire magneto-dielectric inter-atomic has been closed off for the permeability of magnetism. It is the case that the "superconductor" is really a magnetic reflector in its super chilled condition. Magnetism is definitionally spatial movement, in cooling a superconductor (really a super-magnetic barrier) one has created an object with near-0 magnetic inter-atomic 'porosity'.

Dielectricity comes before magnetism, no motion, no magnetism, and when there is almost no magnetism in a super-cooled temperature there is dielectric supra-coherency, which is a super-'conductor' (really a super magnetic-reflector).

Opposite poles of a bar magnet thrust away from each other as far as they can go. That is the very purpose of the electric current which bifurcates the dielectric and magnetic equilibrium. If opposite poles attracted each other they would have to be logically located in the center point of any magnetic (electrified) mass, instead of "pushing" away from each other to the very ends. CW and CCW (clockwise and counter clockwise) pressure gradients weave around and thru each other, and attraction is a perceptual misdirection; so too is repulsion. Like everything else in this world, all has to do with spin. There are no opposite charges attracting each other as regards magnets or magnetism. There is only charge and discharge and their spatial pressure gradients which comprise any field and which are Ether in principle; discharge is merely a degenerative function of charge. Nature has no conception of polarity, logically and reductively so, only CW and CCW spin pertaining to force gradients as relates to EM, magnetism, and gravity in space and over time.

Magnetism is a versor with (space in the field) space, and dielectricity is a versor in counterspace, electromagnetism is a dimensional versor with space and counterspace, which is why there is confusion as to its behavior to “act both as a particle and a wave”. However such insane quantum abstractions are purely absurd; light, like all TEM is pure inductance with a center-radial dielectric component. This is the very same reason why magnetism and TEM can be lensed and directed by specific geometrical shapes (Yagi antennas, lenses, dipoles, reflectors, etc.).

Spatial and counterspatial conjugates regarding micro-magnetic, or macro-magnetic induction between dielectricity and magnetism is the basis for the quadrature of the universe.

Below: How Ether fields, magnetic and dielectric together, against one another, conjugate in a binding system. This is “Field Incommensurability”, or F.I.

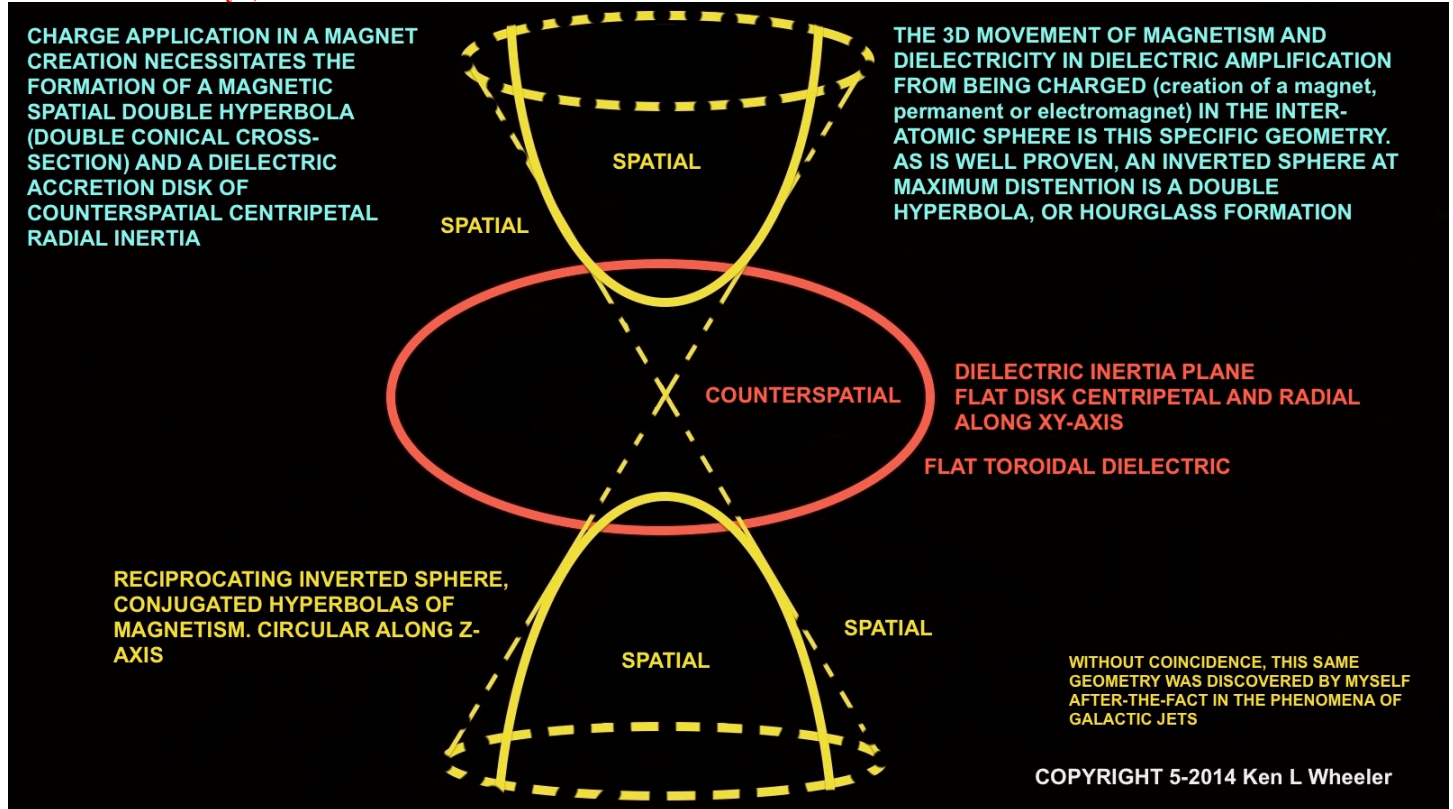

The equator of a bar magnet is the basis for the zero base of curvature and is the dielectric counterspatial inertial plane. Iron filings reaching out from either pole will curve gradually in the ever-changing pressure gradients which surround the poles. Science wrongly calls these curved lines magnetic lines of force, which do not exist, they're pressure gradients in and of the Ether. When the low-pressure curved lines reach the equator which divides the two poles in their spatial vectors, they reverse and repeat their curvature as though reflected by a mirror, which however this perceptual mistake is due to the Ether gradients which are empirically non-quantifiable. However curvature and rebounding at the dielectric plane only occurs in intermediate pressure centrifugal magnetic expulsions which are unable to overcome the dielectric centripetal barriers at a given distance from the magnetic (rather dielectro-gravimetric) centerpoint.

All motions in fields are polarized, are curved, and all curvature is spiral because all motion contains counter-motion or reaction (shot-recoil, charge-discharge etc.), necessitating a double vortex on any magnetized mass. There are no N and S poles in a magnet; only polarized CW and CCW vortex spins and even THIS is still a conceptual spatial error of concept reification, all extension is polarized, all spin is merely 'inverse' as a perceptual defect.

The rubbish and nonsense that any magnet “has a N and S pole” is a perceptual insanity. Any bar magnet can be cut a trillion times into slices like a salami and the very topmost portion will be a bar magnet with CW and CCW spin vortexes ('N and S poles'), and likewise for any portion in the middle or the very bottom.

Just as extreme cold contracts superconductors and makes their magnetic field planes or bases non-existent / diamagnetic in domination; magnets have, due to electrification, greatly expanded dielectric bases and are macro-magnetic resultantly after-the-fact to the charging. Magnets (dielectric objects) are also coherent in their radiative Ether vortexes which follow the coherent charge in expansive and reductive spiral movements.

Logically so since magnetism is a spatial field, extreme cold is a form of dielectric induction. Just as ferromagnetic proximity to a magnet is magnetic induction; extreme cold = lower inter-atomic volume which = higher capacitance = greater dielectricity since dielectricity is greater inverse to the space. Less space, less magnetism, by induction thru inter-atomic contraction, which is inverse to the interatomic contraction from electrification in which dielectric capacitance is greatly amplified and increased in its multiplicative by means of being compounded rather than amplified thru means of inter-atomic contraction from extreme cold. Multiplicative compounding by electrification, or inter-atomic phase coherency from spatial atomic contraction, and loss of magnetic potential due to extreme cold. Without coincidence this is how radiation and magnetism (i.e. heat and otherwise) are symbolically identical on many levels.

In a magnet, the added charge in its creation causes atomic contraction as the spin vortex decreases in radius and increases in speed and moves from in-between the spherical structure to be expelled as a coherent jet from the base of the magnetic field plane of the atom due to field incommensurability, a field-phase pressure conjugation natural to magneto-dielectric binding systems. Necessitated reactions from charge saturation of the atomic ferrous material causes dielectric saturation and micro-magnetic induction to occur and thereby overflow expulsion of the magnetism into the bell-disk geometry we now understand.

Without phyllotactic like CW on CCW or CCW on CW field interlacing, magnetic like on like polarizations will not come together. Using simplex Moire' geometric proofs, I prove that like on like spin creates enormous torsional compression against an already centered pair of conjugate dielectric planes. This is the highest geometric point of compressional movement allowed in magnetic body accelerations towards each other. In great electrification, this is how a rail gun works. A rail gun works by an enormous dielectric inertial pulse of expulsion.

While magnetism reciprocates spatially its movement is always towards the dielectric inertial centripetal plane. While dielectricity and electricity are counterspatial, their movements are radial and generative. Magnetism is a spatial conjugation, a polarization moving outwards in increasing and decreasing pressure gradients towards the dielectric inertial plane, whereas the centripetal counterspatial dielectric increases towards electro-stable generation and is discharged, or terminated in mass and resultantly gravity. A spatial reciprocation and rebounding (in the case of a permanent magnet) occurs towards and against the dielectric like a limitless polarized fountain with a rebounding counterspatial sink. Literally a one-way polarized Ether portal ever attempting to sink the magnetic Ether pressures in voidance against a centripetal rebounding dielectric inertial plane. Since magnetism and dielectricity move opposite each other, this special (as illustrated in the plates) magneto-dielectric geometry is created.

The grand misunderstanding, in ignorance by some, that a magnet has "four poles" is only mistaking observed effects of the magnetism reciprocating in low pressures against the dielectric plane. The polarized Ether (magnetism) reciprocating along and against the dielectric, which is perpendicular to the magnetic (in the binding system, but always moving apart 180 from each other, but perceptually 90 degrees due to the binding magneto-dielectric architecture), is the reason for this misunderstanding of observed effects.

The grand misunderstanding, in ignorance by some, is that a magnet is emitting something, is "emitting magnetism". Magnetism is, of course, merely a polarized Ether bubble from electrification (not 'magnetization' as conventionally understood by the common person) of the iron, or neodymium-iron-boron mass, or in an electromagnet, or as is the case in the inter-atomic magneto-dielectric volume. When a magnet is present (in the conventional macro-magnetic model), the specific polarized magnetic field is present and moves in CW and CCW vortex (or in radial circumferential movements thru transmission lines) thru and around this fountain-sink Ether portal with a greatly increased dielectric plane at which magnetism is spatially displaced on a macro level.

Logically so, magnetism, gravity, electricity, dielectricity are only distinctions without a difference in speaking conventionally about nuances of the modalities of the Ether, either counterspatial, spatial, radial, centripetal, centrifugal, or polarized. Magnetism is merely the model expression of Ether polarization in a spatially reciprocating circular format. Like gravity, magnetism is the radiative, or terminal (negative) of electricity; whereas gravity is the terminal of dielectricity (as mass in creation, attributionally gravity after the fact).

A former mystery of magnetism now solved: It has long been a mystery as to why the N-S running Alaska oil pipeline is magnetized as the vast amounts of oil running thru the steel pipe churn down the line, however the explanation is simple, the pipeline is being inducted by the movement of the dielectrically charged oil as it passes thru the vortex torrent of the earths magnetosphere, which in turn like the magnet thru the copper pipe demonstrates the Lenz law, is causing magnetic induction of the pipeline from dielectric induction of the moving oil thru the earths field vortex.

The ‘magnet’ isn’t a magnet; it’s an electrified dielectric object

“Let no one say man has evolved sufficiently until he fully understands magnetism both in what it is and how it works” – Author

Dielectric induction vs. magnetic induction. If any small flat square of copper or other high dielectric reflector is waved horizontally against the horizontal dielectric plane of a magnet, instant resistance is felt from dielectric induction. However if the copper piece is waved vertically against the horizontal dielectric plane, there is no reactance (very low). As magnetic polarization affects the magnetic materials (ferrous) so too does the dielectric either move against the magnetic, or as in the example just mentioned, the dielectric induces the dielectric in the copper piece (and repels the magnetic in same). Magnetism against the superluminal dielectric (copper for example) moving in direct opposition to the magnetic spatial field is the electromotive force in the creation of electricity. However dielectric induction along the perpendicular plane to the magnetic polarizations, under very meager motions can be easily felt, as is the cases that the dielectric plane of the magnet is causing boundary dielectric vacuum torsion in the copper piece.

The magnet is the dielectric object with magnetism as an attribute, but the magnetically induced ferrous object is anti-dielectric! The question is begged why a wafer thin magnet can be placed on its edge parallel to the dielectric plane of another larger magnet, and yet any other ferrous disk of identical dimensions, absolutely cannot be; it can be placed perpendicular to the dielectric plane of the larger magnet, but never in parallel to it, reaction is identical to placing (attempting to) N on N or S on S (or as the case really is CW on CW, or CCW on CCW). With the wafer thin magnet resting on its edge in perfect harmony at the dielectric inertial plane in parallel, if you attempt to twist it perpendicular, tremendous resistance is felt and the magnet will leap to either CW or CCW conjugate pole of the larger magnet; inversely to this, a steel disk or ferrous flat piece will rest in harmony perpendicular to the dielectric plane but never in parallel to it, and tremendously resist same in brining it in parallel to the larger magnets dielectric radial inertial plane. The case is that while both the magnet (permanent) and the steel disk are “magnetized”, the reality is the genuine magnet is electrified (in its creation), is a dielectric object (in the order of 80 to 90%) with a necessitated coincidental and attributionally large magnetic field; whereas the ferrous disk is merely magnetically induced in the field of the magnet of which the ferrous disk being so magnetically induced has an extremely tight counterspatial inter-atomic dielectric volume. The disk is merely magnetically induced, whereas the disk magnetic is an electrified dielectric object.

The common idiocy of conventional understanding is that a super magnet (or any magnet) is a “magnetic object, emitting magnetism” which is absolutely not the case, nothing is being emitted as has been mentioned (a polarized Ether field), further still a magnet is an (permanent or electromagnet) electrified object with a powerful dielectric inertial plane which causes enormous spatial (Ether portal) magnetic displacement of which the common person deems said object “a magnet” because its magnetic attributes are easily and well known, but its dielectric dominance is almost unknown, existing in dominance at the perpendicular to the reciprocating magnetic portals. Returning to the steel disk which vociferously resists being placed in parallel or proximity to the dielectric, as is the case, magnetism repels dielectricity and vice versa, the magnetically induced disk is overwhelmingly (temporarily) magnetic and the repulsion is occurring from the dielectric plane of the magnet upon the ferrous disk, the ferrous disk is / does cause dielectric torque which is overwhelmingly powerful. Literally the ferrous disk (which is magnetically induced in the field of magnetism) is causing Z-axis dielectric torsion along the XY-axis of the dielectric plane of the magnet, like twisting an extremely powerful gyroscope along its Z-axis, or axis of radial rotation. Conventional idiocy is that ‘opposites attract’, they in fact do not, opposites repel; this logic assumes that a steel disk will leap to a magnet, however only along the Z-axis of centrifugal magnetic preponderance, and absolutely not to the XY-axis of the dielectric plane. The wafer thin disk magnet however will rest on its edge along and in parallel to the larger magnet, both magnets are dielectro-electrified objects, like attracting like, dielectric along the dielectric. The wafer thin ferrous disk however is purely a magnetically induced object, which cannot be brought close to the dielectric inertial plane of the magnet. Likewise, a wafer thin sheet or disk of copper or aluminum, while not leaping to the dielectric plane will break their movement if swept in parallel against the dielectric plane; the copper or aluminum being dielectric reflectors are being dielectrically induced (and magnetically contracted), since they are not ferromagnetic (-ally inducible materials).

Edgewise motion perpendicular across the dielectric medium by the magnetized iron disk offers very little resistance, however impossible to do so parallel to the dielectric plane. The exact inverse exists for the other disk, which is electrified, the “magnet” which its edgewise-dielectric inertial plane will rest perfectly in parallel to the dielectric plane but the disk’s dielectric plane will (not possible) encounter enormous resistance in attempting twisting against the dielectric and into the magnetic flow. This is a hydrostatic-like Ether pressure in both examples. The value of this pressure is one half the product of dielectric and magnetic density.

A dielectric reflector is in reality a dielectric “magnet” (like to like), it is a ‘reflector’ such that it can, in electrification, be pulsed and its superluminal dielectric inter-atomic inertial plane torqued as a sweeping magnetic field causes dielectric precessional torsion, which produces electrification. A dielectric repulsor is, obviously magnetism (and vice versa), whether as conjugated in a magnetic field in a magnet (an electrified object) or in a magnetically induced ferrous piece, or in our example, the thin steel wafer. Again, the lunacy and common conception is that a nail etc. that is adhered to any magnet is, like the magnet, “also a magnet, is magnetized” is absolute insanity. The case is that only the “magnet” of the first part is the ‘genuine magnet (meaning electrified object)’, but we confuse attribute with principle. The super-magnet or electromagnet is an electric object, in the case of the permanent magnet, a ‘frozen field distention object’.

The permanent magnet is an electrically charged dielectric object, but that dielectricity is counterspatial, inertial, radial, and centripetal, humans do not (none do really) understand that all such permanent magnets have magnetism as secondary attributes to their electrification. That magnetism is spatial, circular, centrifugal (and centripetal) and polarized and acts upon other magnets, and ferrous materials, has lead humans thru all history to deem these objects as “magnetic objects”. The minor attribute of magnetism in a

magnet has supplanted (in the minds of common folk) the major principle, or attribute of its dielectricity. The correct way of understanding a permanent magnet is that it is an anti-magnetic object of inflated (however not spatially) dielectric dominance which has, as necessitated, coincidentally an enormous conjugated magnetic field occurring as a pair of reciprocating inverse-sphere hyperbolas opposite to the dielectric inertial plane.

As if one were to take a porous sphere with clay inside and insert a needle to the center and inject it with a large volume of water, the clay would ooze out of the sphere in thin strings; such is the case of a pre-‘magnet’ which is electrified (water) at which point the clay (magnetism) would become a spatially dominant feature. Any simplex mind would so deem the sphere as a “magnet”, or a “clay ball”. That the water (dielectric) is clear and invisible and has almost no spatial interaction with anything and is a compressed accretion disk that is counterspatial, inertial, radial, and centripetal, people would immediately associate such an object as a “clay” or “magnetic” object such that the magnetism is spatial, circular, centrifugal (and centripetal) and polarized. Human minds do not think electrically or counterspatially, as such any “magnet” (electrified dielectric object) is so deemed a magnet by the spatial senses of common humans.

In the case of the steel wafer disk, while magnetized and in the field of the magnet, it has undergone dielectric contraction and resultantly magnetic dilation which is why it cannot be brought in parallel to the dielectric inertial plane of the permanent (“real”) magnet created from electrification. In the case of the dielectric reflector (copper sheet etc.) along in parallel to the dielectric plane, it is has undergone magnetic contraction and dielectric dilation. Magnetism and dielectricity are always working in lowest possible pressure gradients to move 180 degrees from each other. A permanent “magnet” has enormous dielectric dilation and resultant magnetic secondary attributes. Obviously so, the disk magnet will rest on its thin edge (like on like), dielectric upon dielectric, parallel in tandem with the larger magnets dielectric inertial plane. The mind of “modern” man must be deprogrammed as pertains his concept of what a magnet and magnetism is. Telling anyone offhand that there is another plane in the middle of a magnet between its reciprocating fields that in fact outright repels a magnetically induced, or magnetized ferrous object, is rejected as either insane or obtuse, however even a 10 year old can reproduce this fact readily. A genuine magnet is an electrified mass with an enormous stored dielectric field, and its likewise secondary attribute, magnetism. In the case of the magnetically induced ferrous disk, it is magnetized while in the field, but it is not polarized in the genuine sense as only applicable to the electrified mass which is polarized from dielectric preponderance. It must be clearly differentiated that a magnetized, or magnetically induced ferrous object is within a magnetic field but it is not of its own accord a polarized magnet, which is also why you cannot place in parallel such a steel disk alongside the dielectric inertial plane of the genuine “magnet”.

As is the case in cutting any bar magnet perpendicular to its polarization, of course we note that we can have infinite magnets with each one having a CW and CCW ‘pole’. While this is fairly well know, what is not known is the theory of magnetic domains is incorrect, rather mostly so. Conceptually it is accepted that the 1 magnet cut into 10, 100, 1000 each with their own pole is merely a reduction in size of what are infinitesimally smaller “magnetized pieces” or smaller magnets. What is not understood or mentioned however is that each smaller magnet has an immediate center-seeking dielectric plane. It is literally as if any piece removed from the earth, it were sliced horizontally along its polarity, would, at the speed of light (possibly faster), create a sphere to match the volume of the slice with an immediate equatorially spinning inertial line. These infinite numbers of magnets with perfect polarity are not resultant from infinite numbers of magnetic domains but that the electrified “magnet”, is like gravity itself (both centripetal), and both are instantly self-seeking.

A permanent “magnet” is a permanent battery in two dimensions. The process of pushing the magnetic lines of force outwards in electrification, in the creation of the magnet represents stored energy as in a rubber band stretched outwards. No power is required to maintain the stationary field of the “magnet”, this represents stored energy. This trapped inductance of energy is unique to the ferrous materials and to the hexagonal nature of neodymium ferrous objects. When the power supply circuit is removed from electrification at the end of the creation of the “magnet”, there is no interruption in current. The extremely special incommensurable geometry of the spatial-counterspatial magneto-dielectric nature of a magnet allows for this energy storage in the dielectric inertial plane which has as secondary attribute, the reciprocating magnetic field.

From the illustrations below: We have, at picture 1, the “magnetic” disk resting against gravity in parallel to the dielectric plane of the large 2x2x1” magnet, whose dielectric inertial plane is illustrated in green. In picture 2 we have the steel disk sitting (it almost will rest on its knife edge) perpendicular to the dielectric, which is the only low torque position in line with the magnetic circular induction, marked in red. In fact, even using a magnet twice this size, and many 100s of times the weight of the steel disk, the torque of the steel disk along the dielectric will move the magnet to keep a perfect perpendicular; the same is true in reverse for the disk “magnet” in parallel to the dielectric of the block. The steel disk is magnetized, is a magnetically induced disk in whole, whereas the block and disk in picture one are electrified, are “magnets” only conventionally but are in fact dielectric objects in near-whole, and so deemed “magnets” because the magnetic ‘part’ is spatial and the near-whole, dielectric, is counterspatial and radial. This is magneto-dielectric momentum; identical to gyroscopic inertia, however here we have dielectrical centripetal inertia and circular magnetic inertia expanding along the Z-axis (see diagrams of magnetism in other sections of this article). Massive confusion exists that this is the “boundary wall, domain wall, Bloch wall” of a magnet, it is not, it is the primary mover of the magnetism, having been electrified, it is the dielectric inertial plane. Breaking the magnet will cause an immediate (faster than light) creation of a new self-centering dielectric plane. As per figure 1 I can place the brick magnet on a 500 pound refrigerator and not making contact with the tiny few-grams disk magnet, twist it from parallel against the dielectric plane against the brick magnet and make the 500 pound refrigerator shake resultantly there is so much dielectric torque at play. This among many other experiments is proof that dielectricity is at play in any magnet as primary, and magnetism itself as merely an attributional secondary. You certainly could not cause such a reaction by way of magnetism alone from the disk magnet to the 500-pound object, that would be impossible; only by means of dielectric torque.

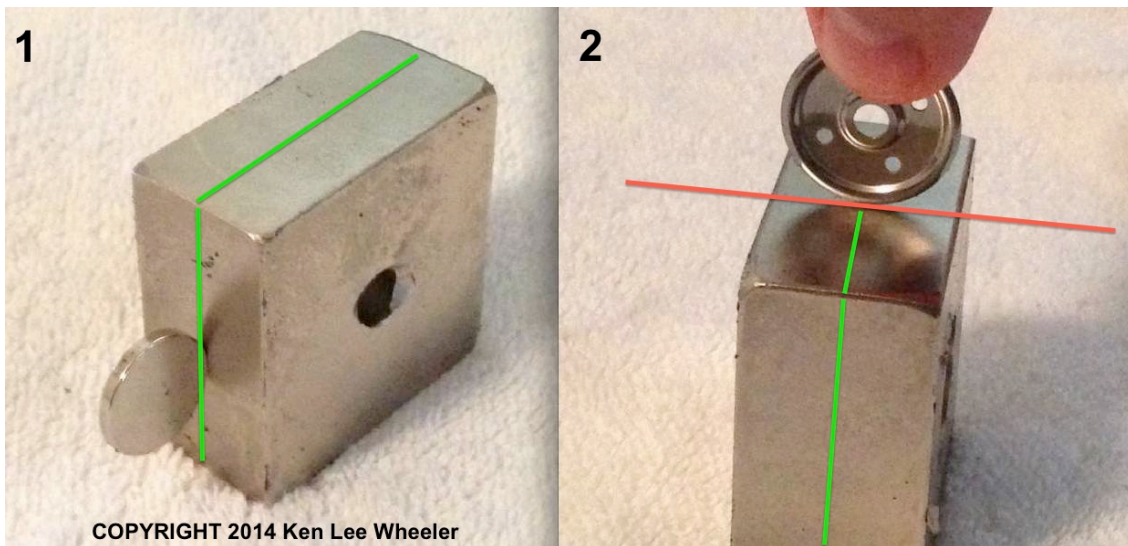

Magnets, naturally, are spatially self-folding, but not due to magnetism

“If man but understood magnetism in true, he would seize the universe by the tail” – poem

How many flat magnets have I broken over the years on accident to realize an extremely important point, and then start breaking them on purpose to further prove the point! As is the case, thin disk magnets with the dielectric inertial plane on edge, or hard drive magnets with the dielectric plane running along the flat curve invariably desire self destruction, self-folding at the dielectric plane. Hyper-logical, simple, and necessitated in retrospect given the fact that the dielectric plane is distended in all magnets and is centripetal and counterspatial by nature. Magnets will rupture and self-collapse in upon themselves at their dielectric planes! In the case of a disk magnet where the dielectric lays along the thin edge, obviously breaking it along that edge is readily impossible, however the dielectric will self-fold along the weakest point at which it can draw in its centripetal force (“black hole”, a misnomer of course, since black holes do not exist), by breaking into four pieces like a pizza cut with 4 perfect 90 degree giant slices, and immediately self-fold to the smallest, tightest spatial dimension possible. Every new break in the flat magnets creates a new self-centered dielectric inertial plane that wants desperately to spatially fold on itself!

Factually and mathematically, if a large thin ceramic magnet or a new hybrid crystalline structure (something far superior to neodymium iron boron) were able to be brought up to a gauss level approximately 400% beyond current max levels of N55, and then released from its structurally binding form, keeping it spatially in place like a bookmark between the folds of a book, this magnet, at currently unachievable gauss states, would **instantly and violently self-fold** at multiple breaks into a volume (depending on radius and thickness) approximately $1/6^{\text{th}}$ its current surface area. **This fact is undeniable and proof positive of the counterspatial nature of dielectricity, long ago well established by Tesla, Maxwell, Heaviside, and Steinmetz.** This is a glaringly obvious fact from electrical transmission lines where the smaller the bounding structure, the greater the dielectric capacitance. *“Hereby we may say that the dielectric field is contractive, and the magnetic field is expansive.”*

The endless hard drive magnets I have broken (now many times on purpose) will invariably split and self-fold along their dielectric planes which run across the middle of the thin semi-circular hard drive magnets. On several occasions, in breaking the more powerful hard drive magnets 3 to 5” electrical charges are shot out like lightning at the instant of breaking, releasing the dielectric (some of) inertial momentum into an immediate energy free space transference! The most stable dielectric geometry of any magnet (though most not that powerful magnetically, because of dielectric stability) is a sphere. Thin powerful “magnets” are quick to take any shock and self-fold.

Conventionally one might, incorrectly, state that these thin magnets self-fold out of impetus for CW on CCW (‘poles’) proximity, however this is seeing things in reverse, these magnets fold along the lowest pressure point for the tightest (smallest) spatial volume to suit the dielectric nature of what a “magnet” genuinely is. This is of course, also why when two magnets are brought together; the dielectric planes immediately re-center themselves as one to the midpoint between the two. That dielectricity behaves very closely to gravity is no coincidence whatsoever. Since each new magnetic break creates a new dielectric self-centered inertial plane, to insanely think that the magnet will ‘fold due to the obvious attracting magnetic fields’ is thinking backwards, as do most people. Likewise one might look at a horses ass and declare horseshit (self-folding) to be the ‘product of the horse’ (magnetic field), when in fact of course, the ‘horse’, is merely the processor and digestion device (“magnet” mass) for the grass it’s fed (electrification creating dielectric dominance). This folding effect is pure logic and rooted in the “grass”, the electrification which creates a ‘frozen’ dielectrical dominance over the “magnetic mass” which is as stated, a dielectric object in true. Like our horse, no grass (electrification), no horse (magnetization). As Maxwell and others have stated, dielectric precedes the magnetic.

Below: The dielectric inertial plane of a typical hard drive magnet, on right is the conjunction of a folding magnet, having folded once already. This cross is the dielectric counterspace which will, given the chance, fold all possible unnecessary space into the smallest spatial volume possible. Only magnetism gives massiveness to mass and matter.

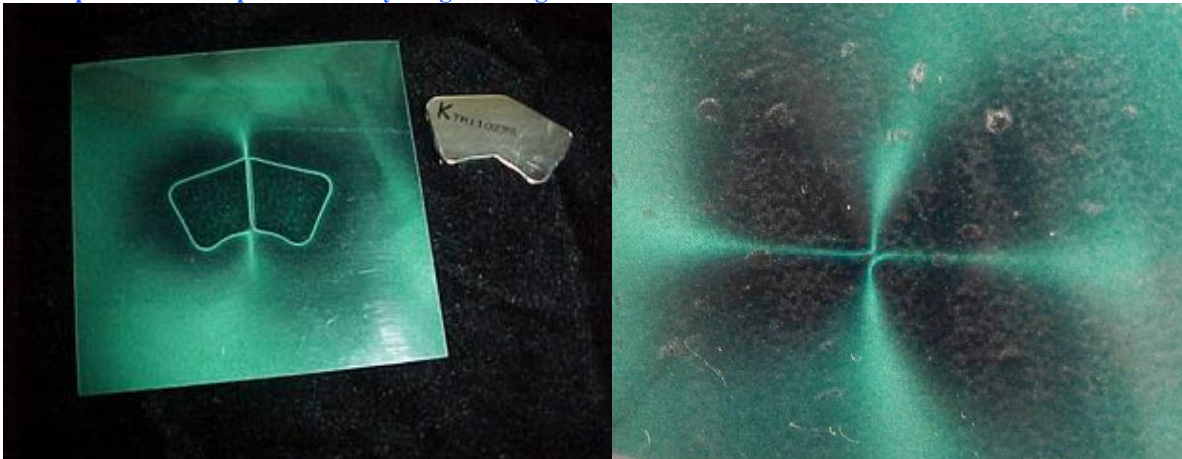

The dielectric plane is always trying to transform any “magnet” of odd shapes and forms into a sphere. If you break a flat hard drive magnet roughly ten times you will end up with a jagged and sharp, albeit nevertheless a sphere. Since magnetism is spatial and dielectricity is counterspatial, more magnetism can be store in more space, and inversely so with dielectricity; from this fact we can re-affirm what we already know about the “magnet”, that it is a dielectric electrified object with magnetism as a secondary incidental byproduct, such that breaking a flat disk magnet of great spatial geometry will collapse into a smaller and smaller form as possible, proving that, of course, the “magnet” is the counterspatial seeking electrified object. When dielectricity far greatly overcomes the spatial magnitudinal pressures of mass, a special stellar object is formed.

As discovered on 7/15/2014, an inertial plane, long before magnets go into voidance (connection/ attraction), is forming at the decreasing equatorial line of the voidance-sphere. The implications for and of this are enormous. This discovery was made using a testing medium as yet undisclosed. Amazingly, this should have been predicted to occur. However as is the case, an inertial plane forms within the space (as an attribute OF the fields!) between the accelerating bodies undergoing voidance. Dielectricity finds the byproduct of its radiation field (magnetism), that being space, as intolerable. This is part of the conjugate nature of and between dielectricity and magnetism.

Below: As just discovered, at the equatorial sphere of accelerating magnets, an inertial plane has already formed at the shrinking equatorial sphere. In an instant there is no magneto-dielectric difference between the space (as defined by the fields) between two accelerating magnets and that present in the center of any magnet, as a gravitative-dielectric field-modality.

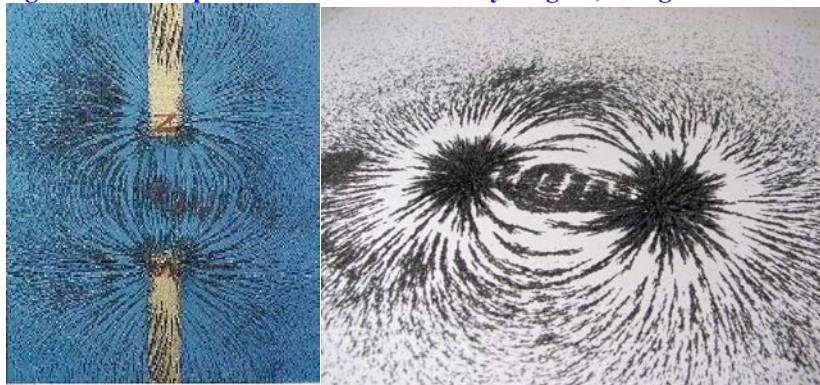

Below: Field incommensurability necessitates that magnets self-fold in dictate of the nature of the dielectric inertial plane.

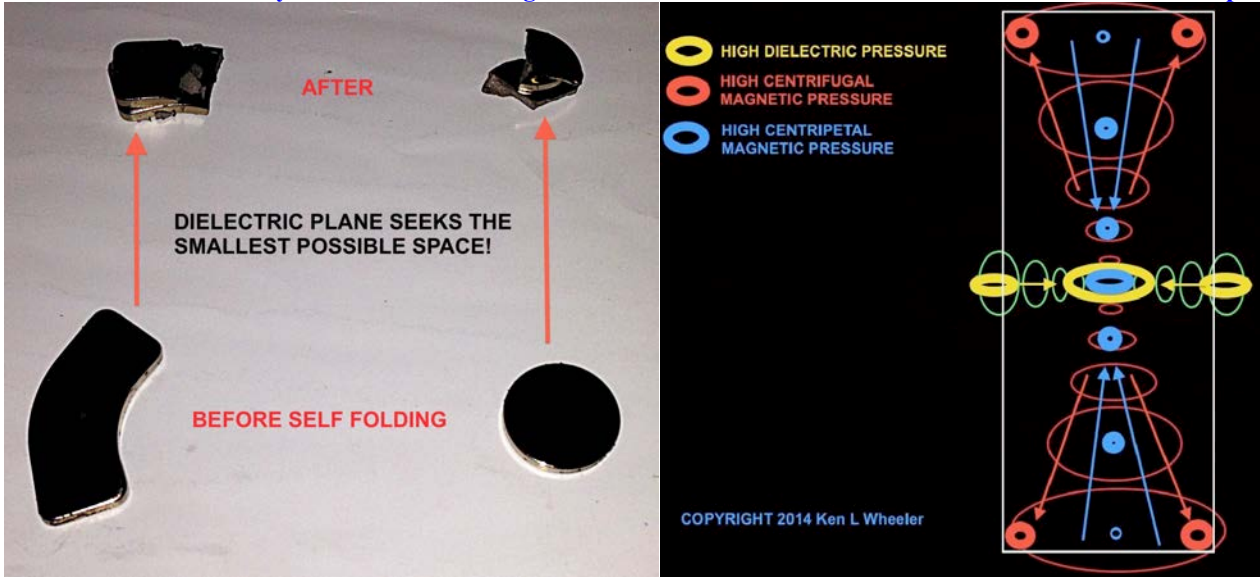

Magnetic pressure is highest at the boundary points between mass-spatial barriers; at the outer edges of either reciprocating pole, and at the dead center of any magnet, its dielectric center, not its mass-center.

Dielectric pressure is highest as a torus of the dielectric center of any “magnet”, which is also the gravitative center, additionally the dielectric extends like an inertial plane torus along the equator of electrification, incorrectly called the “Bloch wall”, but which in fact is the dielectric inertial centripetal plane of the dominant force in any so-called “magnet”.

Below: Broken ring magnet “re-attached” as a ring, but **NOT AS IT WAS BEFORE IT WAS BROKEN, but HOW it can exist after broken**. On right, the black markings indicate that this piece, or half-portion of the ring was originally located on the other side. **While this LOOKS ‘re-assembled’ it is not**; it is the only way (other than on top of each other in a double crescent) it can rest, in this case, AS A RING. The same would be true of a disk magnet broken in half as well. This is the action of dielectric counterspace in how “magnets” DO and WILL ‘self-fold’ and decrease as much space as possible. On left is the field view of the flipped (self-flipped) broken ring magnet.

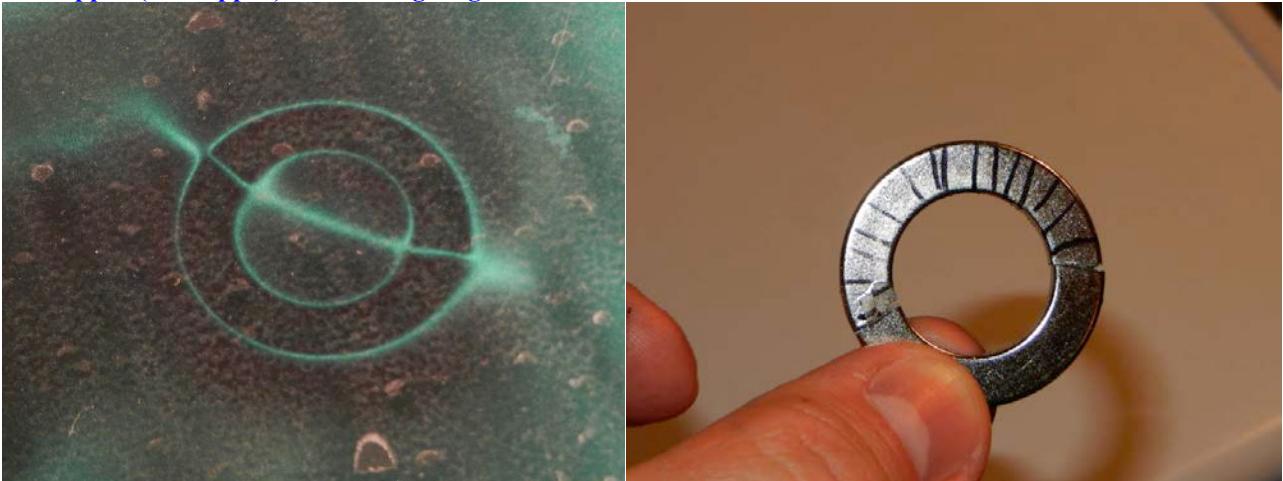

Below: Broken ring magnet, which naturally flip itself to the lowest pressure dielectric voidance (which would actually be a pair of double crescents on top of each other in, as it is broken, into smaller and smaller spatial volumes), on right, same broken ring magnet seen edge-on. The cross, or X pattern is the ‘first stage’ of dielectricity’s ‘desire’ to fold-up space into the smallest volume possible. Here we see on the photo at right, from left to right, N, S, and bottom, S, N.

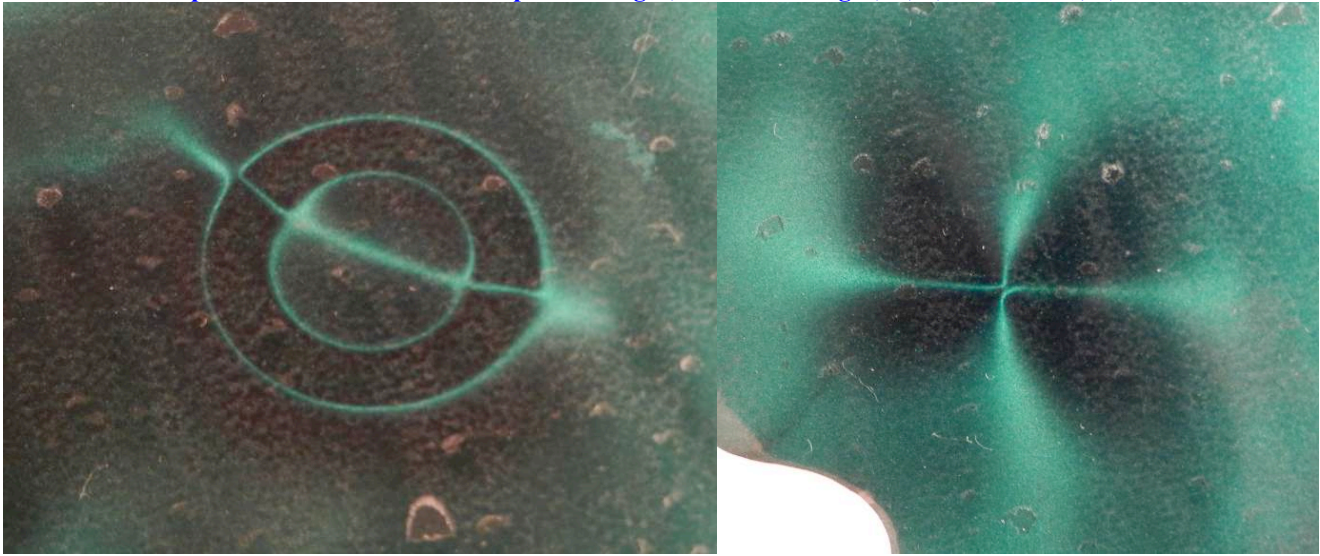

Below: Identical ring magnet but whole and unbroken, its field views top-down on left, and on right, its dielectric inertial plane seen edge-on, on the side of the ring magnet.

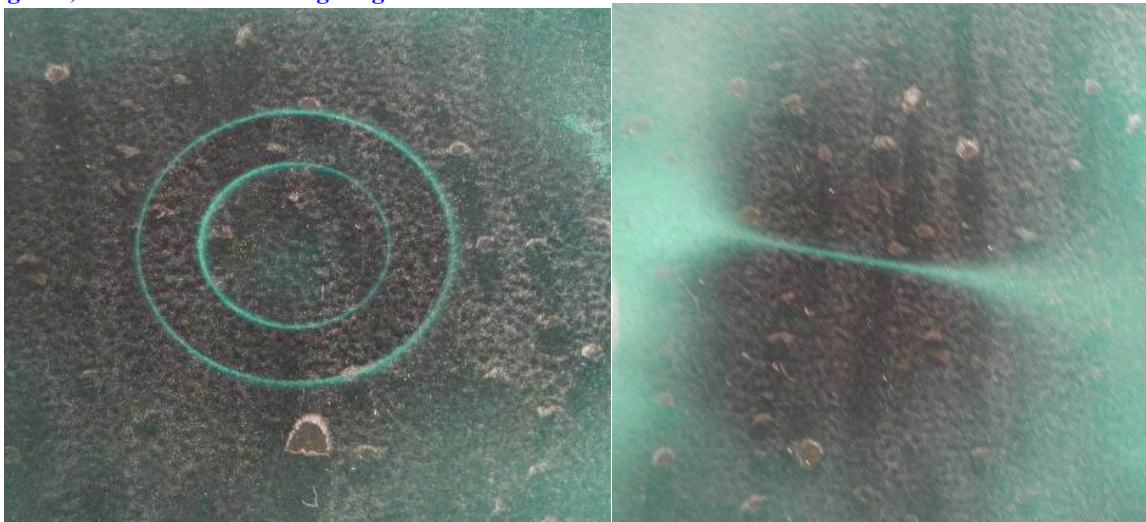

Electrified (dielectric or electric):

1. Reflects light (EM) spatially along XY-axis = dielectric radial conductor (‘dielectric reflector’ as meaning magnetic reflector that is dielectric in nature, non-ferrous) along the Z-axis = electrical reflector at the Z-axis = electrical attractor at the spatial circular XY-axis (radially polarized when current is present from AC electrification) = magnetic reflector. Any strong magnetic reflector is likewise a dielectric conductor and an EM (light) reflector (but not its center co-axial dielectric component). Electricity and magnetism flow spatially and radially in circular polarization along the XY-axis to the perpendicular Z-axis dielectric. Reflects light = polarization reflector and counterspatial conductor. A perfect conductor is a perfect magnetic reflector; it has no magnetic permeability due to being supra-dielectrically coherent, as in the case of a super cooled yttrium barium copper oxide disk. Supra-dielectric coherency is due to extremely low magnetic movements and high in-phase dielectric coherency. A super cooled perfect magnetic reflector is, in essence, a dielectric ‘laser’, as would be the case a ‘P.A.D.I.M.C.’ (Phased Amplification of Dielectricity by Interatomic Magnetic Constriction). Any interatomic volume and movement is magnetic by principle, the dielectric phasing by super cooling is magnetic retardation.

2. Magnet or electromagnet (electrified ferrous object) = non-magnetically dominant object = dielectric object = magnetic induction reflector along the XY-axis = dielectric at the XY-axis, magnetic at the polarized expanding Z-axis = magnetic attractor along the expanding Z-axis.

3. DC is polarization at the source; AC is polarization along the radial path of conduction.

Not electrified:

4. Ferrous material (not electrified, magnetic medium) = magnetically induced is a dominant magnet = magnetic inductive object =

spatial magnetic capacitor at XYZ-axis.

5. Material that absorbs light (dielectric medium)= dielectric capacitor at XYZ axis = non-ferrous, dielectric object (if illuminated by EM).

Electrical current, or permanent magnet?

“Is that the egg laid by the chicken, or is that the chicken that was hatched from the egg. One fool says the chicken laid the egg first, another fool says the egg hatched the chicken first. I tell you that regardless of both, you don't have either one without the farmer and his feed”

The question becomes, of the two diagrams below, one being graphed, the other showing iron filings on the left, which of the two is showing the cross section of a permanent magnet, and which is showing current moving in opposite directions as in AC lines (blue representing the dielectric, and red the magnetic)? The answer is that both are showing both current moving in opposite directions and the cross section along the Z-axis of a permanent magnet. In the iron filings illustration on the left, you need only connect the two conductive AC wires with a line (however in 3D it would be a flattened toroidal accretion disk) and you have the XY-axis ‘accretion disk’ of dielectric counterspatial, inertial, radial, and centripetal dominance and the vertically expansive spatial, circular, centrifugal (and centripetal) and polarized magnetic reciprocating field. Of the diagram on the right, you need only connect the two AC conductive wires with a line once again, and compress vertically, the blue dielectric lines into a flatter profile to fit the dielectric geometry into a magnetic mass (or “magnet”) rather than free hanging space AC lines. Both illustrations are that of field or currents (both Ether in nature) moving in opposite directions and the cross section of a permanent magnet. Likewise in an alternating current situation, the feed lines are pressing apart in free hanging space which allows for more magnetism (whereas current in the same direction, the current lines are pulled together which allows for more dielectric storage). This electrification in creating a magnet means the dielectric, while centripetal, exists predominately like a gyroscopic flywheel mass, along the periphery at which the center Z-axis is the reciprocating magnetic field portal. In its fixed form of a permanent magnet, the compressing dielectric centripetal counter (spatial) force is working in direct opposition to the magnetic, with the dielectric attempting to come together at the XY-axis centerpoint, while at the same time, the magnetic is attempting to push the XY-axis apart at the centerpoint, resultantly like stepping down flow from a larger diameter pipe into a smaller one, there is increased pressure, or in this case, increased magnetic pressure of which we, incorrectly, deem an electrified dielectric object, as a “magnet” or “magnetic object”.

Ironically (not so) electrification in the creation of a permanent magnet creates significant spatial magnetic polarization, whereas an identical relationship exists likewise in the spatial-counterspatial geometry as created in current lines that are polarized, and have current moving in opposite directions. This is the harmonic conjugate relationship of magnetism and dielectricity, spatial and counterspatial, both moving 180 degrees opposite one another, however in a binding electrical system, or a “magnetic” mass create an unique centripetal-centrifugal, radial-circular, inertial-radiative, spatial-counterspatial set of relationships, so fully and accurately spelled out by the gods of electrical theory, Maxwell, Heaviside, Faraday, Tesla, Steinmetz, and others.

Both diagrams show the same geometry, but in different electrical dimensions. Alternating electrical current being polarized, produces the same magneto-dielectric geometry as electrification produces in the creation of an ‘electrified’ dielectric object (“magnet”) with spatial magnetic polarization. Electrical current polarization produces a temporary building radiative polarized (there is no other kind) magnetic field, or in the other case, magnetic polarization formed in the electrification of a ferrous mass into a dielectric object with a fixed radiative magnetic field. When electrified, the ferrous mass retains (due to the special inter-atomic magneto-dielectric elasticity of the volume of iron) high dielectric capacitance, also proven in experimentation in releasing this dielectricity (light reflector = dielectric conductor, iron in its special nature can be stably dielectrically saturated from electrification).

In one, polarization exists in the opposite-moving electrical counterspatial current to produce radiative polarized magnetism, in the other, polarization exists in the spatially radiative magnetic as created from dielectric saturation from its formation by electrification. Electricity terminates in magnetism, but not the dielectric (which terminates in gravity/ mass creation). This is how Tesla was able to have dielectric systems with no corresponding magnetic component; whereas all electrical systems have spatially radiative (and terminating) magnetic components, either from electrification in the creation of a magnet by dielectric ferrous saturation, or by opposite moving current lines, or in a DC line with a radiative circular magnetic field. Either a strong dielectric saturation creates a macro-dominant magnetic portal, or a strong pair of current lines moving in opposite directions will produce same.

To think that an electromagnet is different than a permanent magnet is wrong, both terminate electricity into the dielectric upon which magnetism is exuded. That the electromagnet is being fed by a power source to create the magnetic field as it terminates into the dielectric is no different than a permanent magnet which has been electrified and, due to the magneto-dielectric ‘elasticity’ of iron retains that dielectric geometry permanently. It is wrongly thought, as is the case with most peoples minds that are looking at magnetism upside down and backwards, that iron is ‘ferromagnetic’ in potential, but it is just the inverse, rather that it is supra-dielectric in capacitance (and more so in hexagonal neodymium iron boron architectures). Magnetism cannot exist as an independent entity in any form in and of itself, it must be induced by another, as in TEM, or as a permanent magnet, or as an electromagnet, or as the byproduct of galactic charging as found in galactic jets, around DC lines, or around AC lines. Electricity terminates into magnetism by way of a dielectric-capacitance object (dielectro-electromagnetism, or ‘electromagnetism’ contains a radial dielectric Z-axis component).

Magnetism is literally the polarization of dielectricity as contained or induced by an object (permanent magnet, TEM, electromagnet), the two are conjugate and inversely proportional in their magneto-dielectric architecture, where one is circular, dielectricity is radial, where one is centrifugal-centripetal, dielectricity is centripetal, where one is radiative, dielectricity is inertial,

where one is spatial (polarized), dielectricity is counterspatial. This conjugate pair creates and props up the entire universe, and powers all atomic elements, is responsible for charge, discharge, induction, radiation, generation, polarization, mass creation which likewise terminates into gravity. An incapacity to understand this fundamental is a roadblock to any true comprehension of magnetism or dielectricity. Where magnetism seeks static circular polarization, electrification is a radial dynamic polarization.

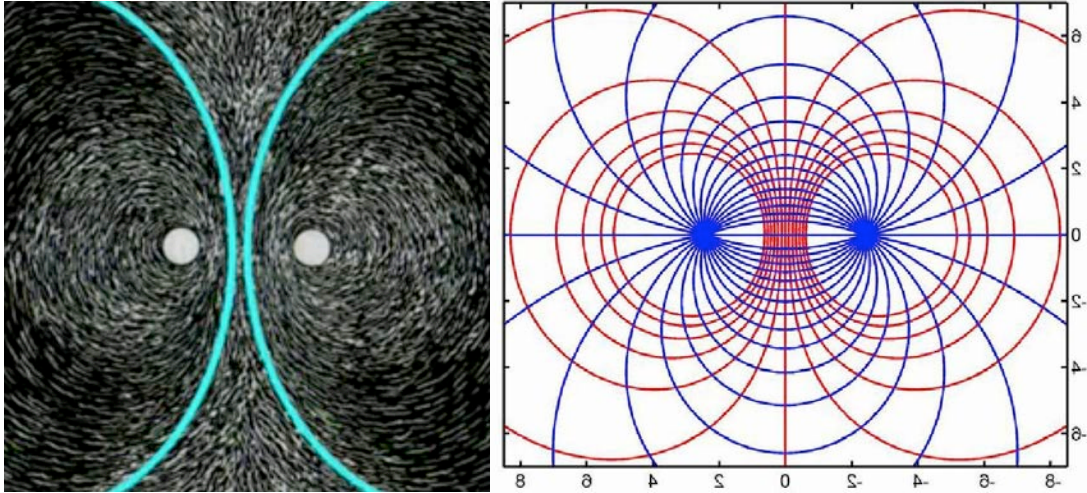

Magnetism: 1. Centrifugal (centripetal on return = polarization) 2. Circular 3. Radiative 4. Spatial
Dielectricity: 1. Centripetal 2. Radial 3. Inertial 4. Counterspatial

Magnetic Geometry, or the Bell-disk mutual-repulsion model of magneto-dielectricity

The great mystery, now understood, is that while magnetism and dielectricity move 180 degrees from each other, in binding closed systems where gravity is immense, either in galactic structures, or in nuclear structures, the disk-dumbbell formations of dielectricity and magnetism move 90 degrees (only perceptually, rather completely opposite from each other in true) from each other in the special geometric formations of a disk and a pair of inverse double hyperbolas, since the structure is of course binding and contractive, this is the lowest pressure model of magneto-dielectric mutual repulsion. How do two opposite forces that are “tied” together in a binding system (inter-atomic, galactic, permanent magnet) move 180 degrees from each other when one is spatial and polarized, and the other is radial and counterspatial, the answer is an inertial plane accretion disk and a double hyperbola. What appears as perpendicular movement is in fact the maximum repulsion of a binding system.

Below: This is the lynchpin, the missing secret of atomic volume, permanent magnets, galactic jets, and how Ether fields, magnetic and dielectric together, against one another, conjugate in a binding system. Radial-counterspatial and circular-spatial forces in a binding system (dielectricity and magnetism, the two co-principles of the universe) can only exist in this geometry (in a perfect example). This is **“Field Incommensurability”, or F.I.**

The great mystery, now understood, is that while magnetism and dielectricity move 180 degrees from each other, in binding closed systems where gravity is immense, either in galactic structures, or in nuclear structures, the disk-dumbbell formations of dielectricity and magnetism move 90 degrees from each other in the special geometric formations of a disk and a pair of inverse double hyperbolas, since the structure is of course binding and contractive, this is the lowest pressure model of magneto-dielectric mutual repulsion! How do two opposite forces that are “tied” together in a system (inter-atomic, galactic, permanent magnet) move 180 degrees from each other when one is spatial and polarized, and the other is radial and counterspatial, the answer is an inertial plane accretion disk and a double hyperbola. What appears as perpendicular movement is in fact maximum repulsion of a binding system.

THIS IS OPPOSITE MOVEMENT IN A BINDING SYSTEM, NOT PERPENDICULAR

This geometry is only seen in the macro-world when one is charged or out of equilibrium with the other in coherent and sufficient quantities to be visible. In the stable inter-atomic, this fundamental charge-pressure geometry is responsible for all molecular bonding, however in greatly compounded complexity.

INTERSECTING SPATIAL AND COUNTER-SPATIAL FIELDS (magnetic & dielectric) are necessitated by pressure and geometry to create this configuration

COPYRIGHT 6-2014 Ken L. Wheeler

Below: Left is a computer proof that the maximum throw of an inverted sphere is a dumbbell shaped geometry. Second picture is that of a double hyperbola of the magnetic dominances in a permanent magnet, third picture is the dielectric stricture of the magneto-dielectric interatomic to create a macro-magnetic phenomena. Far right are atomic orbitals showing snapshot diagrams of what these magnetic dominances are relative to the nucleal fulcrum, at which one can always deduce the location of the dielectric in this system.

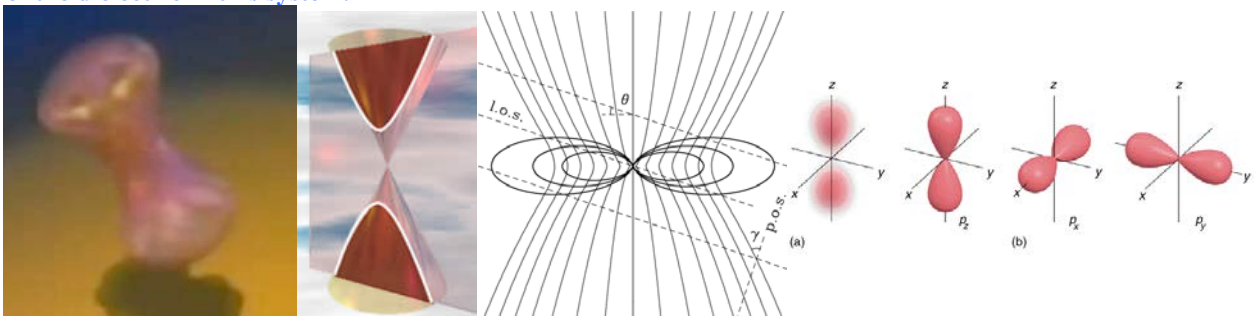

The surface outer perimeter / edge of either portal (pole) on a magnet has the highest centrifugal pressure and velocity upon exiting the magnetic mass (opposite of that of a tornado, whose ground apex has the highest velocity and cone the lowest velocity).

Expulsion apex velocity is low, expulsion cone velocity is high. Centripetal apex sink velocity is highest. The centripetal cone is the magnetic spatial radius.

The expulsion cone velocity being high creates a preponderance of low Ether pressure (dilation) at the center of either pole at which the centripetal sink is directed. Low to moderate pressure expulsion will be directed at the Bloch wall from the side equator rather than centripetally thru the opposite end vortex.

Below: Left, 100 nanometer scale proof of the geometry of magnetism. On the right is the inverse sphere geometry of magnetic dominances in any electrified system where the dielectric dominates over the magnetic.

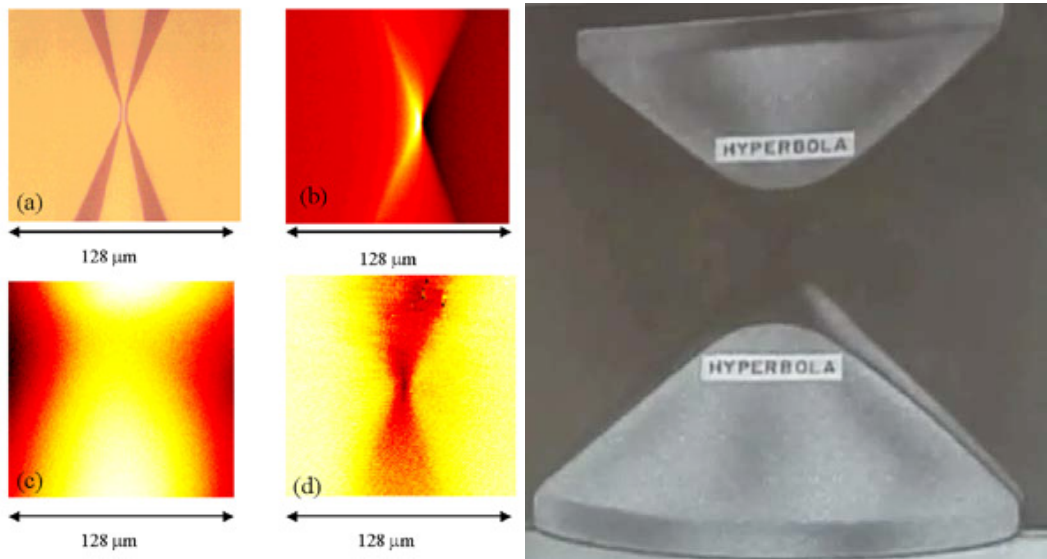

An expulsion vortex has highest acceleration at the cone and a centripetal vortex has highest acceleration at its apex. Where Ether pressure velocity equals Ether vacuum there is a return to the closest vacuum with a non-opposing spin.

A sink vortex has maximum velocity at its apex of the returning centripetal field, and the expulsion vortex on the centrifugal cone, has its highest velocity at the cone-base, opposite that of the centripetal returning vortex. Looking down on any 'pole' surface, this would paint a velocity image of a single ringed bullseye where the center is maximum centripetal returning velocity, then an intermediate zone, all ringed by a high velocity centrifugal vortex of expulsion.

The centrifugal expulsion point of the magnet has the lowest Ether pressure gradients at the polarized centerpoint, to which the returning centripetal apex is directed and accelerated towards. This dilative vacuum is also the instrumental mechanism of avoidance, or conventionally thought of as 'attraction' (so-called).

This is why the velocity on either pole of a magnet is greatest at its edge where centrifugal expulsion is occurring and greater still at its center where the apex of the returning conjugated 'pole' field is centripetally vortexing into the dielectric inertial plane, or Bloch wall of avoidance, which is the epicenter of the lowest-pressure gradients.

The spatial base of any polarized magnetic double vortex has its geometric equilibrium at Phi, where its sloping counterspatial apexes are always at the intersection 1. This discovery has implications so important and far reaching, you cannot fathom it. This is the 1-1-Phi isosceles triangle of Pythagoras.

The maximum geometric expulsion of a point or sphere inversion is a double cone centrifugally leaving or inverting at a negative pressure of 1-1-Phi; of which a positive pressure of the field magnetic vortex leaves at a spiral of 1/Phi (.618). Therefore the expulsion **0-point apex is $1/\phi^3$ (4.23606) and the 0-point motive is ϕ^3 (.23606)**. The missing secrets of Phi are covered in another article.

Below: Left, a pair of cylinder magnets, in the middle a sphere magnet, on the right the field illustrations.

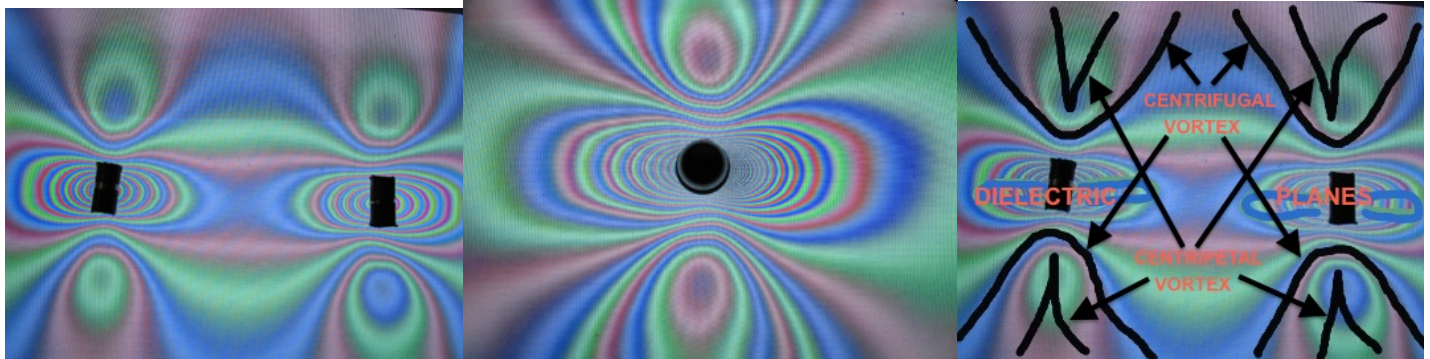

Below: Left is a circular magnet on a CRT display showing very clearly both the magnetic geometry and the dielectric plane. On the right we see low pressure magnetic field movements that are returning along the dielectric.

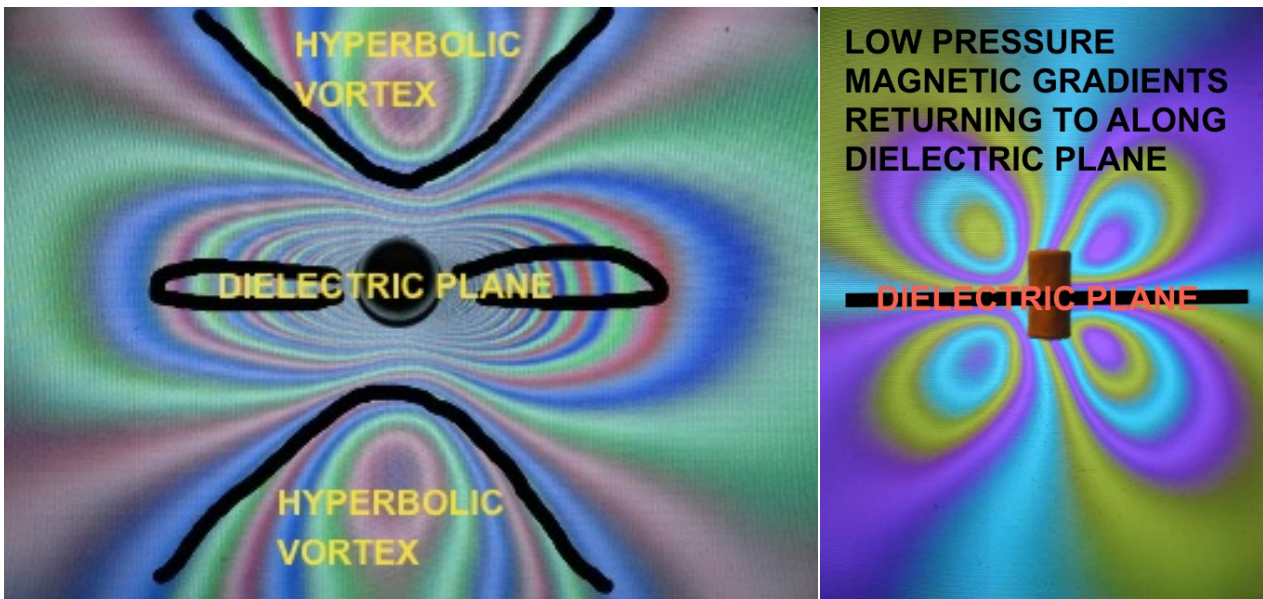

Below: Left, showing circular polarization against a CRT screen, on the right, detailed picture of the earths magnetic field showing clearly the dielectric plane at the equator.

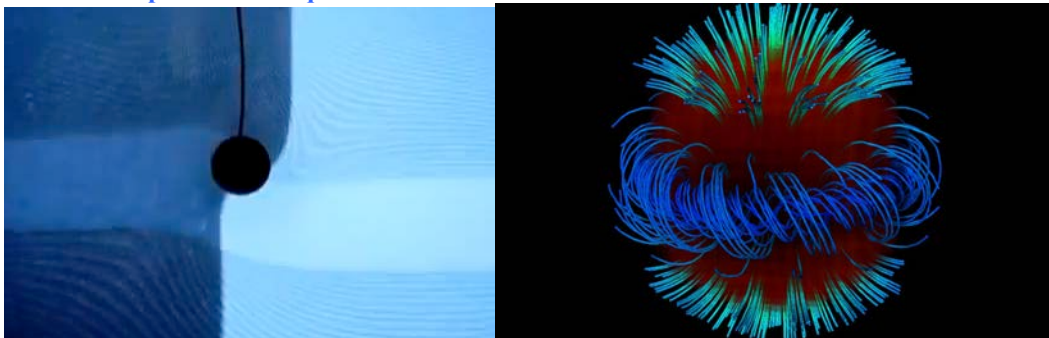

All magnetic geometry is a double expulsive centrifugal bubble vortex and double centripetal returning vortex and a singular magnetic field spatially polarized. A singular undivided Ether movement and perturbation.

That magnetic Ether pressure gradients are high on the surface from either centrifugal vortexes or returning centripetal vortexes is a source for the long held lack of discernment of magnetic vortexes.

Below: Not coincidentally my discovery coincides perfectly with the QM model of certain atomic geometry, however in error they wrongly attribute this to 'electrons'. What in fact you are seeing of course is the dielectric inertial plane and the dumbbell shaped magnetic preponderances as conjugated in the binding system of the atom. This geometry of course, depending on charge, or magnetism, or nucleal charges, can become much more complex than this. Far right is field geometry of the physical "magnet" showing dielectricity forced at, concentrated at the mid-point of the physical magnet. Likewise showing is the divergent discharge of dielectricity, the magnetism.

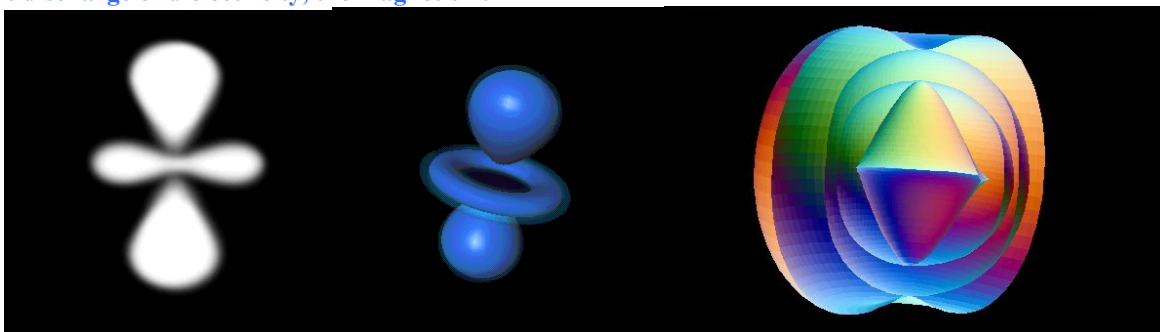

Since magnetism is spatial, there is an optimum throw distance from the dielectric inertial plane at which the velocity of the pressure of expulsion is overtaken by vacuum centripetal forces which, in the case of extremely long magnets or bar magnets, the preponderance of the double magnetic vortex bubble and the magnetic spin vortexes form a sphere around a magnet rather than a polarized double fountain at either end. Spatial acceleration in a geometric form can be extended only so far before vacuum reversion quickly overtakes expulsive throw. The ideal ratio is a base of 1 and a height of Phi, or just the inverse is also ideal.

Below: Very long bar magnet example where the physical magnet geometry can overthrow the actual field pressure at either end of normal CW or CCW rotation.

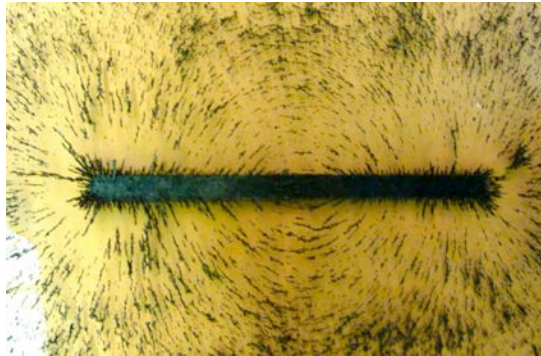

Below: Regardless of how many times you break a magnet against any line parallel to the dielectric inertial plane, you will have yet another magnet. This is field incommensurability, likewise self-similarity as also exists in a holographic positive.

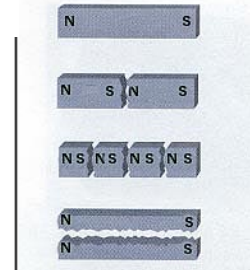
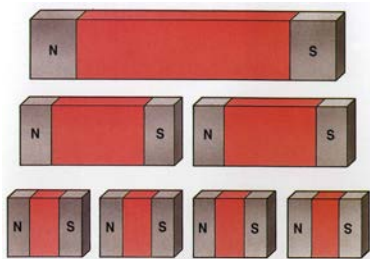

Magnetism continued

All of the most fundamental principles of nature and the universe can be solved with simplex Euclidean math and geometry; along with Platonic logic. If same cannot solve it, it does not exist. - *Author*

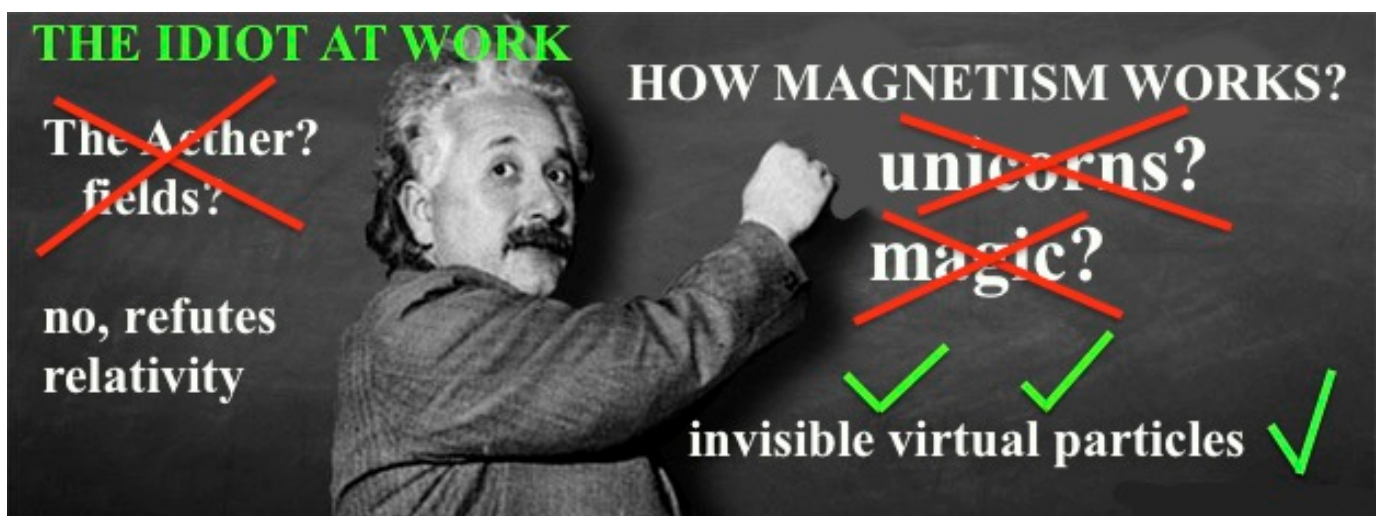

Both electricity and magnetism seek discharge. That is not to say there is a negative terminal but a lower or vacuum Ether pressure into which electricity and magnetism seek to discharge themselves. Of electricity we speak of the ground whereas in magnetism we wrongly think of the “other pole” however the “other pole” is merely inverse spin, in fact the “ground” of a magnet is self-terminating

on its lowest pressure gradient within the dielectric inertial plane.

Positive charge attracts positive charge and terminates into a negative discharge. Negative discharge repels both negative discharges and positive charge. The fact that electricity terminates into magnetism does not mean that it repels it. Termination is not repulsion.

Counterspace is just a conceptual means of speaking about the Ether plane, where everything is produced, and all fields are based in this 'medium'. Tesla knew this, Steinmetz, Heaviside, Maxwell, and even the fool Einstein, before he lost his mind, agreed that understanding is impossible without the Ether.

Magnetism is strictly an end product of dynamic polarization into static radiative polarization, or as the byproduct of dielectric saturation which expels the resident magnetism in a system. All magnetism is created as a byproduct of dielectric manipulation, either by electrification into a mass which distorts the dielectric (meaning acceleration and capacitance) and likewise in turn the magnetic, or as the necessitated conjugate to electrification in TEM. This binary of electrification is pure inductance in which the electrical induces the magnetic and vice versa. This reciprocal creation occurs along a counterspatial Ether plane in which the reciprocal induction is radiated.

Electricity and magnetism exist as separate appearances only when opposed. In non-opposition they disappear as in the case of stable inter-atomic field charges. They become one, meaning dielectric dominance in the inter-atomic causes appearances of the macro-magnetic.

Below: The 'gyroscopes' analogy of field incommensurability as pertains to magneto-dielectric conjugate phasing from electrification, in the creation of a permanent "magnet". Self-similarity parallel to the dielectric inertial plane is an absolute necessity in dissection, or bifurcation along this plane.

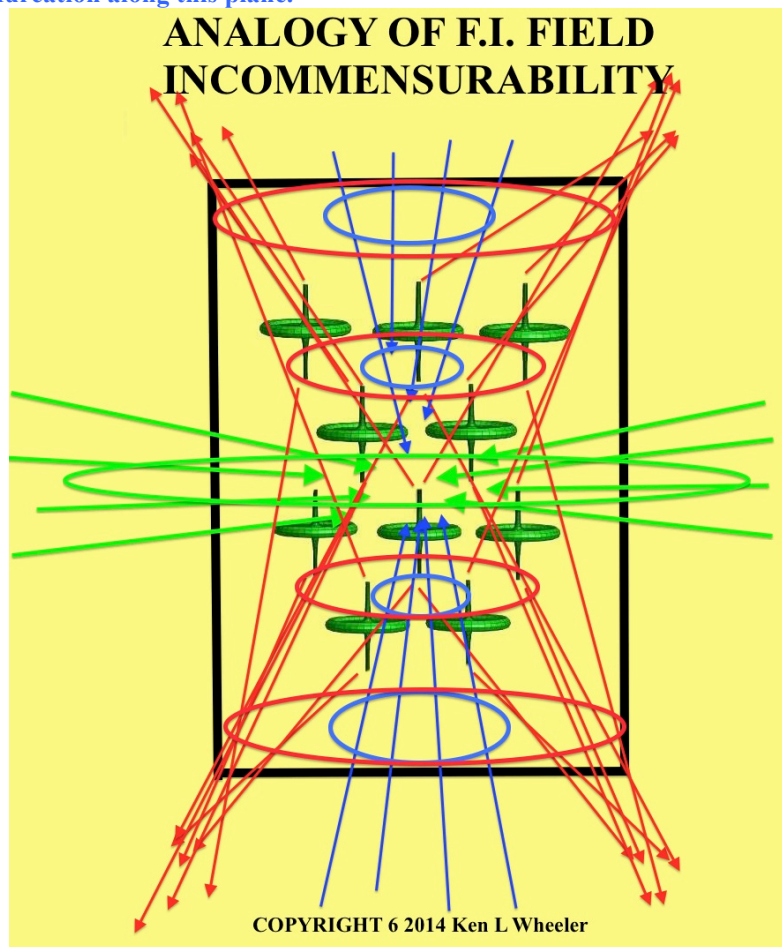

Opposites are not attracting, if so then the two poles would be at the center rather than at the ends. Cut a magnet a billion times and one side still has CW spin and the opposite still has CCW spin. The magneto-dielectric comprehension of a "magnets" 'mechanics' is simple, but not simple to the brainwashed minds of most who grew up with misconceptions about what a magnet IS and how it works.

If the atom were 99.999999% empty space as the priests of the cult of quantum advocate, then their non-existent electrons would spiral into the nucleus. All atoms, as is necessary to understanding the magnet itself, are multifaceted ‘balloons’ with magnetic and dielectric charges throughout. There isn’t even .0000000001% of ‘empty space’ in the atomic structure. To believe in quantum is just placing false beliefs based upon nothing, this is CNAP (convoluted nonsense and poppycock).

Why do certain heavy elements have small volume geometry and certain lightweight elements have enormous volumes? Because neutrons are dielectrically dominant and counterspatial by nature. (discussed further on)

That positive charges terminates in the negative terminal doesn’t mean that negative attracts the positive terminal. This is another reason that reification of electrons as entities does not exist.

Magnetism is Ether in preturbative movement however the polarity of same is a perceptive error, this binary is spatial vortex movement into itself, so deemed the “negative pole”

The laser analogy

*“If someone were to ask what is the **most simple explanation of what a permanent magnet really is**, the answer is that it is a coherent binary field object; or one might easily declare a permanent magnet a ‘field ‘laser’’. - Author*

Whether by magnetic induction causing dielectric coherency from a magnet to an “unmagnetized” (as really meant inter-atomically incoherent random dielectric inertia) soft iron piece, or a charge dump from a capacitor bank to a ‘magnetizer coil’ (an incorrect designation) thru a ferrite magnet or neo magnet, the resultant is the same with respect of difference in increased capacitance, and that difference is F.I. or field incommensurability.

The conventional logic in speaking of “aligned domains” is meaningless nonsense, while descriptively accurate, is explicatively absurd and senseless nonsense. What is and does occur is the ordered inter-atomic coherency of dielectricity and the resultant macro-magnetic phenomena which is therefore called a “magnet”. However all magnetism is a posterior resultant to a prior which is dielectric coherency.

Without taking the analogy too far, we can state, for clarifications sake, **that a “magnet” is a field ‘laser’**, within which the incommensurate conjugated inter-atomic magneto-dielectricity is coherent throughout the object we call a ‘magnet’, resultantly achieved by charge dump from a capacitor bank thru a charging coil into the pre-‘magnet’ or by magnetic induction of a magnet to a soft iron object.

This dielectric coherency and alignment is necessitated as dielectricity and magnetism are mutually repellant Ether modalities, one with inertia, the other the resultant spatial vectorization of dielectricity in loss of inertia.

Ultimately building dielectric coherency in a diode, or HeNe laser, or at the inter-atomic magneto-dielectric of iron or Neo-iron-boron is fundamentally no different. In both cases the conjugate nature of dielectricity and magnetism (in the case of the laser, the transverse magnetic component of the radial dielectric nature of light) are brought into mutual coherency and point non-specific self-similarity. In both cases we have a mutual spin-deflection from applied charge or an applied field which causes field alignment of the dielectric component resultant to an applied charge or induction from applied magnetic field. In which case as regards both examples, dielectric inertia is brought into coherent concentration which then produces resultant macro-magnetic phenomena. In the case of the laser, we have resultant coherent radial dielectric light emission.

One must apply concentrated logical thought to the nature of an applied magnetic field to a soft iron object in which case **the inter-atomic dielectric becomes coherent by presenting its centripetal circumference to the applied magnetic field.** We know that magnetism and dielectricity exist always 180 degrees from each other even in a magnet where it is APPARENTLY (only so) 90 degrees. This ‘dielectric presentation’ to the applied magnetic field in presenting its centripetal circumference to the magnetism maintains Ether conservation of the dielectric inertia.

Dielectricity maintains its inertia one of two ways in coherency from an applied external (or internal) magnetic field from another, either by presenting its centripetal circumference or thru (in the case of the magnet) gyromagnetic precession wherein which magnetism is mediated in and thru the binding system we know as the “magnet”.

Below: Conventional HeNe tube laser within which the emission end contains a 95% mirror and the rearward oriented full reflectance 100% mirror, or 'back mirror'. The HeNe is the gain medium which builds near instant coherency from applied charge. As is known, a 30-watt light bulb (incoherent) is worthless, whereas a 30-watt laser (coherent light) will burn a hole in you. This intense reflectance builds coherent parallel radial dielectric capacitance which is only blocked by the transverse electromagnetic components of light.

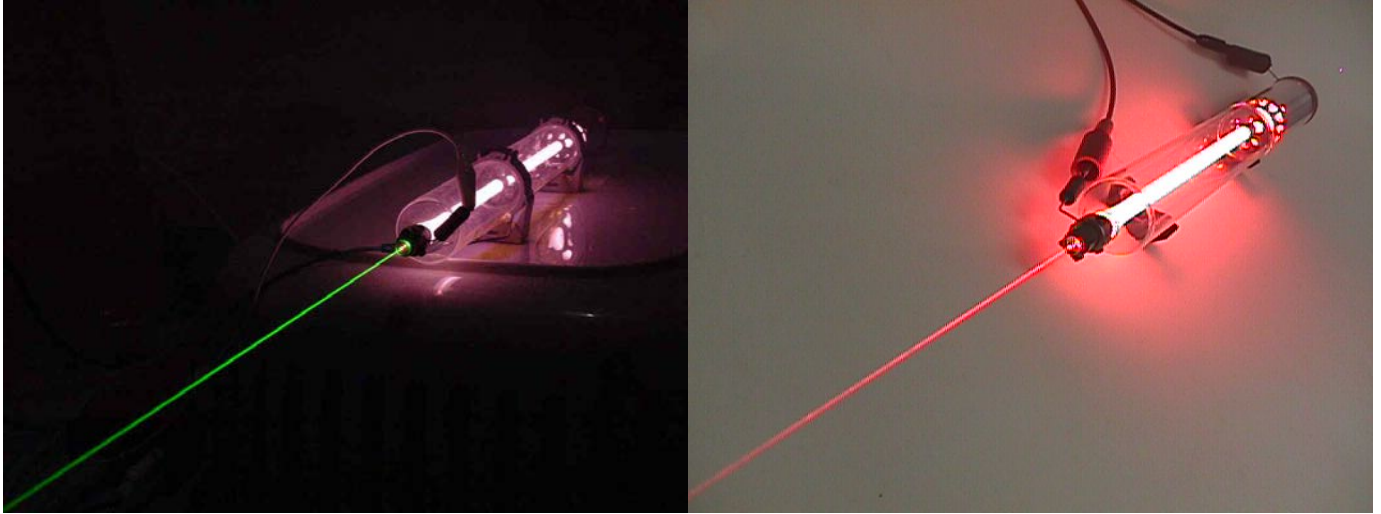

Magnetism continued II

Magnetism radiates and thereby creates space within this radiative field, but only spatially unto itself, an Ether bubble brought into being from coherent macro-magnetic amplification. Neither magnetism nor dielectricity can terminate in space, but only on themselves or into counterspatial conductive terminals.

Magnetism not only moves 180 from the dielectric but also from the magnetic as the "poles" vortex thru and away from each other. The real 'secret' of magnetism is that the dielectric is attracting the dielectric by centrifugal and centripetal spatial reciprocation of the magnetic. Field incommensurability is extremely simplex, but not simple, and unknown to people who do not ever think in terms of fields or pressure gradient equalizations. We just are not taught such things.

The dielectric and magnetic are two opposed fields occupying the same sphere when in equilibrium, they are not 'seen' when electrified, the dielectric field is amplified and causes macro-magnetic preponderances.

Pyrolytic graphite placed over a magnet, from either side of the magnet if you drag the graphite CW over the magnet the graphite goes CCW and if you drag the graphite suspended in water CCW over the mag, the graphite goes CW.

Below: Field incommensurability. 1 Showing two neodymium magnets apart. 2. Using magnetic viewing film showing the two dielectric inertial planes of two magnets. 3. Showing the two magnets at voidance together. 4. Using magnetic viewing film showing the UNIFIED (voidance) dielectric inertial plane, and the magnetic field as if it were a single “magnet”, which magneto-dielectrically, it most certainly is, field pressures are incommensurable and self-equalizing, as logic and necessity dictate them to be.



Magnetic Inductance is a polarized dimensional relation for the magnetic modalities of appearances (so to say) of the Ether, and Dielectric Capacitance is thus a non-dimensional inertial relation for the dielectric modalities of the Ether. For the magnetic induction the Ether modality is known as the magnetic permeability, for the dielectric induction the Ether modality is known as the dielectric permittivity.

Magnetism is by nature the rotary polarized terminus of electricity, a waste product and necessitated conjugate terminal of charge-discharge terminals of natural electrical inertia and momentum. Dielectricity is electropositive, and magnetism is electronegative, magnetism is centrifugal and electricity is centripetal towards the nucleus. A magnetic mass has a higher dielectric charge because its inter-atomic dielectric volume has decreased from electrification. Remember the smaller the space, the more dielectric capacitance

Humanities wrong conception of magnetism as the ‘attractive’ or positive force is of course fundamentally a huge error. This error is tied to every meaning of the very word “magnet” and “magnetism”. The universal connotation is 180 degrees from the physical denotation of what magnetism really is and does, what causes it, and what sustains it.

Magnetism is dimensional, the dielectric is intradimensional, or in counterspace, and only when these two Ether fields move against each other over time is there electrification, which is the Ether in a modality of dynamic polarization.

Anything at rest doesn’t exist. Aether in its natural state is counterspace, is rest, but declared not to exist because it has no appearance other than as associated with dynamic fields (all fields). The only subject ever to be at rest is the Ether when not in perturbation, hence the “unmoved Mover”.

This law (Newton) was written to fit non-existent premises which were mistakenly presumed to exist. A body cannot continue its state of rest because bodies at rest do not exist in Nature. Bodies are only the waveforms of motion. When all motion ceases, so too do the masses themselves. One might as appropriately refer to sound being at rest in silence, but of course this is absurd, since the absence of sound is not a modality of sound, but its utter voidance.

A stationary (so presumed) magnetic field needs a continuous stable inertial, a dielectrically charged inter-atomic geometry which can maintain its stasis, for the magnetic current to remain stationary, in equilibrium.

Every atomic and inter-atomic (as meant the magneto-dielectric volume and nucleus) must first be wound up like a watch by centripetal electrification before it can terminate in an ever unwinding fashion as meaning the appearance of macro-magnetic polarization, the spatial ‘unwinding’ of centrifugal-centripetal reciprocation. In taking a string of small sphere magnets and looping them into a circle, any child would notice that this greatly reduces their magnetic acceleration towards common iron for magnetic induction. This is every “pole” of each sphere terminating immediately back into counterspace, the loop of polarization has itself been looped into voidance by directing the polarization of inverse spin (due to extension as space = polarization by definition) into and upon itself, thereby terminating polarization before it can reach out (very little) spatially.

Two children cannot move while they are in balance with their fulcrum on a see-saw, since motion is, macro-atomically impossible when there is equilibrium inter-atomically. The division of balance in the creation of a “magnet” is due to the electrification causing high dielectric inter-atomic capacitance in the “magnetic mass” which is the dielectric object in true. The atom is always in movement even when there is magneto-dielectric equilibrium.

Imagine two kids on a see-saw spinning around parallel to the ground just over a fence, you cannot see them, since they both rest just below the fence line (inter-atomic volume), this spinning cannot be stopped, ever, since matter, atoms are by definition motion, there are no 0-rest mass particles in the universe. Looking edge on, these two children are spinning so fast one only see a singular mass, a blur (if you were to look ‘over the fence’ into this atom), but nothing is visible from behind the fence. Now replace one child with a much fatter one, the spinning around the fulcrum, or nucleus cannot stop, ever (however ultimately all matter terminates given enough time), but now one child is raised above the fence line, the skinnier child as it loops round and round. This is how a magnet is created, the “fatter child” representing electrification terminating in the dielectric inter-atomic of the magneto-dielectric volume of the atom (the supposed ‘empty space’ of GR and QM insanity). Humans in their ignorance see only the skinny child, the magnetism looping round and round above the fence line (macro-magnetism, or the ‘magic’ of what has fascinated everyone about magnets for so long), but which humans have not, cannot, still do NOT see is the fat child of dielectric inertial capacitance that is driving the entire mechanism we wrongly see as a “magnetic” phenomena. That science has dedicated LESS THAN a single line, a footnote of a footnote to the “Bloch wall”, the magnetic “domain wall” is proof 100% positive that (among other reasons too numerous to count) humans in no way understand what magnetism really is, what is driving it, what created it, how it is maintained.

Motion is impossible in an absolute equilibrium. Balance must be divided into unbalanced opposite pairs before motion becomes possible ferrous or ferrous compounds (neodymium iron boron) electrification is of course that unbalance

Neither pole is attracted to or repelled by the other. Or, one might as reasonably and insanely assert that houses and trees which are being sucked into the cone of a tornado are attracted by the air itself, the wind rather than by the motion of the wind. The “magnet”, or electrified dielectric mass which it properly should be called, does to the iron filings exactly what the tornado does to the houses and trees. The field of magnetism is an inertial polarized terminus of electrification. In making an analogy of a pre-magnetic mass as being equal to the “air” of our tornado, why then does this lifeless lump not accelerate towards iron, or pick up enormous weights? Churning up that “air” into polarized circulation from electrification creating a dielectric inertial plane dynamo out of the now “magnet” is the prime mover of one field conjugating the expulsion of another field. Imagine a electrical lab stirrer, you turn on the power (electrification), which turns a magnet (the dielectricity in this analogy!) that spins the liquid (magnetism) inside the glass jar (physical magnet).

Since a magnet is inter-atomically dielectrically charged in creating a powerful inertial counterspatial centripetal plane, which, definitionally resists change, this “lab stirrer” of ours, the “magnet”, continues to stir AFTER the electrification, or power has been turned off due to the magneto-dielectrical ‘elasticity’ of iron and iron crystalline compounds (neodymium magnets), just like squeezing a ball of clay around its radius (squeezing = electrification, the constriction = dielectric inertial counterspatial plane) will create a permanent dumbbell formation. Our pre-“magnet” lump has been magneto-dielectrically ‘squeezed’ into this formation. There is nothing “in a magnet” that makes it a magnet; everything is field pressures in nature. Everything. There is nothing pre-“magnet” of the mass, or post-“magnet” of the mass repelling, accelerating, only Ether field pressures.

This is, again, the 800-pound gorilla the cult of quantum and GR and their priests find impossible to understand, explain, and outright deny. Obviously that the conjugate fields are coincident to and of the “magnetic” mass is not in doubt, but ultimately we are speaking of two holes in the Ether-membrane of counterspace where one empties into (dielectric, centripetal) and another ‘pours from’ itself from both ‘ends’ only to run around to the other side of this same portal and return. That portal, in the analogy of the circulating polarized magnetism, is a portal of dielectricity. All centrifugal field movements are centripetal movements in spatial extension. All fields are Ether modalities, with no exceptions.

Below: Lab stirrer analogy of creating a magnet by electrification and inducing dielectric capacitance into the magneto-dielectric 'elasticity' of the iron or iron compound with resultant conjugate macro-magnetic expulsion from the inter-atomic volume as amplified by countless trillions of atoms in coherency expelling magnetism. The magnet is in reality a macro-model of the micro-inter-atomic pressure geometries at play between dielectricity and magnetism after electrification. The rest-'level' of the magnet is pre-electrification in which the pre-'magnet' mass is in geometric equilibrium at the inter-atomic volume. In changing this equilibrium (again, a permanent magnet is stable) the 'water' of magnetism is centrifugally expelled (not repelled) from the surface of the physical, now-electrified "magnet" which is really a supra-dielectric object.

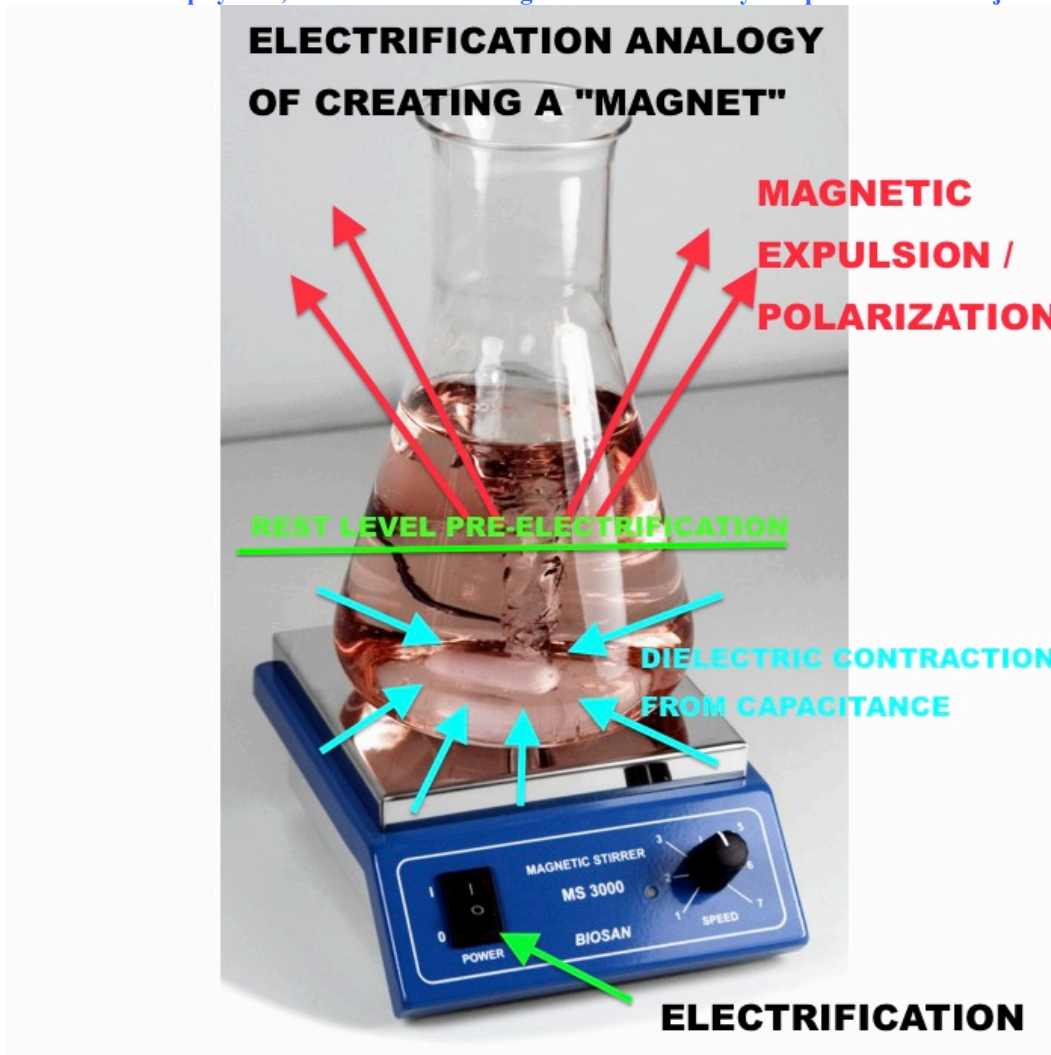

While magnetism and dielectricity are conjugate and reciprocal to each other in a state of equilibrium (even the permanent magnet is an 'equilibrium' by nature of it being a permanent magnet however its magneto-dielectric geometry has been altered into a stable distension) it is the case that magnetism is polarized and spatial, and dielectricity is a centripetal radial counterspatial inertial plane; likewise therefore the magnetic field is many thousands of times 'larger' in volume (=space) than the positive generative dielectric field, though both their potentials are equal in a stabilized system

When "opposite poles" (a fallacy of perception) cancel each other out in counterspace, the meeting of CW on CCW or CCW on CW is the dielectric Ether membrane causing (cancelling) magnetic polarization by avoidance. The logic of counterspace, it seems to the ordinary mind almost insane, but bringing N on S or S on N is like emptying a fountain with a hoop or membrane with no spatial component. Empty a 'hole in space' with another hole, laughingly. However as mentioned there is no Ether in space, only space within the Ether when Ether modalities are manifest, as electricity, dielectricity, magnetism, mass-matter and its attributional gravity field which is also, like dielectricity, centripetal. There is another field entirely that nobody knows about, at least not conventionally as a 'field', but that will be saved for another article.

When the so-called positive pole of a magnet is brought into contact with the so-called (wrongly) negative pole of another magnet, that effect which we think of as attraction is one of centripetal counterspatial avoidance. As any will note, the dielectric plane re-centers itself between two magnets brought together. This avoidance is the utter oppositional power to manifest polarity and the avoidance of magnetism at that locus. Just as weight is location and medium specific, so too are magnetic gauss fields location (magnetic velocity)

and medium (dielectric voidance into counterspace). Polarization ceases at the point of counterspatial voidance. As has been said elsewhere, if 'opposite poles' were self-attractive, then magnetism would be at the center of the magnet rather than at the spatial surface of the ends of a magnet.

Ultimately there are no magnetic 'lines of force', all are merely Ether pressure gradients, pure and simple. Electricity, dielectricity are not 'separate forces' or substances, rather different modalities of the Ether in motion, in circulation, centripetal, centrifugal, or both, linear, longitudinal, transverse, radial, spatial, and counterspatial.

Below: Both pictures are the same, as seen with different mediums of demonstration. However this is only the view of a SINGLE VECTOR of divergent centrifugal magnetism and its convergence on the other side convergently and centripetally.

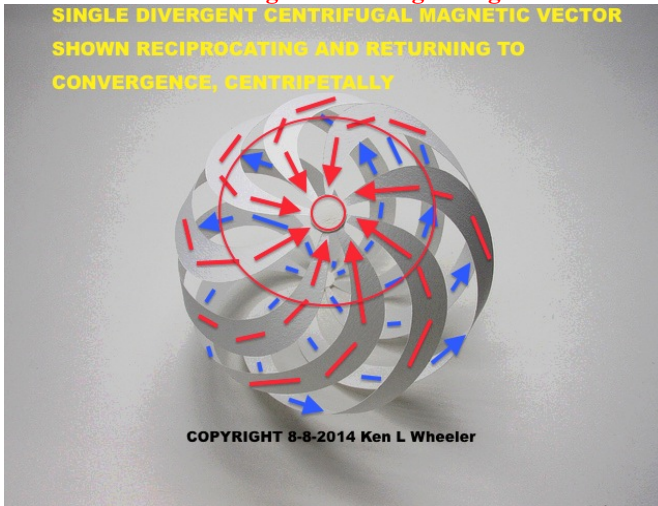

Below: P1 and P2 stand for pole 1 and pole 2. D = divergence, C = convergence. FM = field movement. AM = apparent (unreal movement) movement. Both sets of pictures are the same, as seen from slightly different angles of the poles. **However this is only the view of a SINGLE VECTOR of divergent centrifugal magnetism and its convergence on the other side convergently and centripetally.** Inverse and interlaced superimposition of the pictures below would be necessary to show the identical but reverse polarity and its reciprocation. Blue arrows demonstrate the divergent vector becoming the red arrows of convergence. As the arrows indicate, spatial polarity is indeed both extremely simplex and at the same time extremely complicated perceptually, and add to this the necessity to demonstrate a magnet, this must be inverted and doubled to show the complete picture. All field movement is relative to the inverse polarized field opposite; but as is the case, both sides (not shown below) moving divergently appear, relative from either side opposite, but from each side alone, appear to be moving in the same direction. This is where all antinomies and opposites in the universe begin.

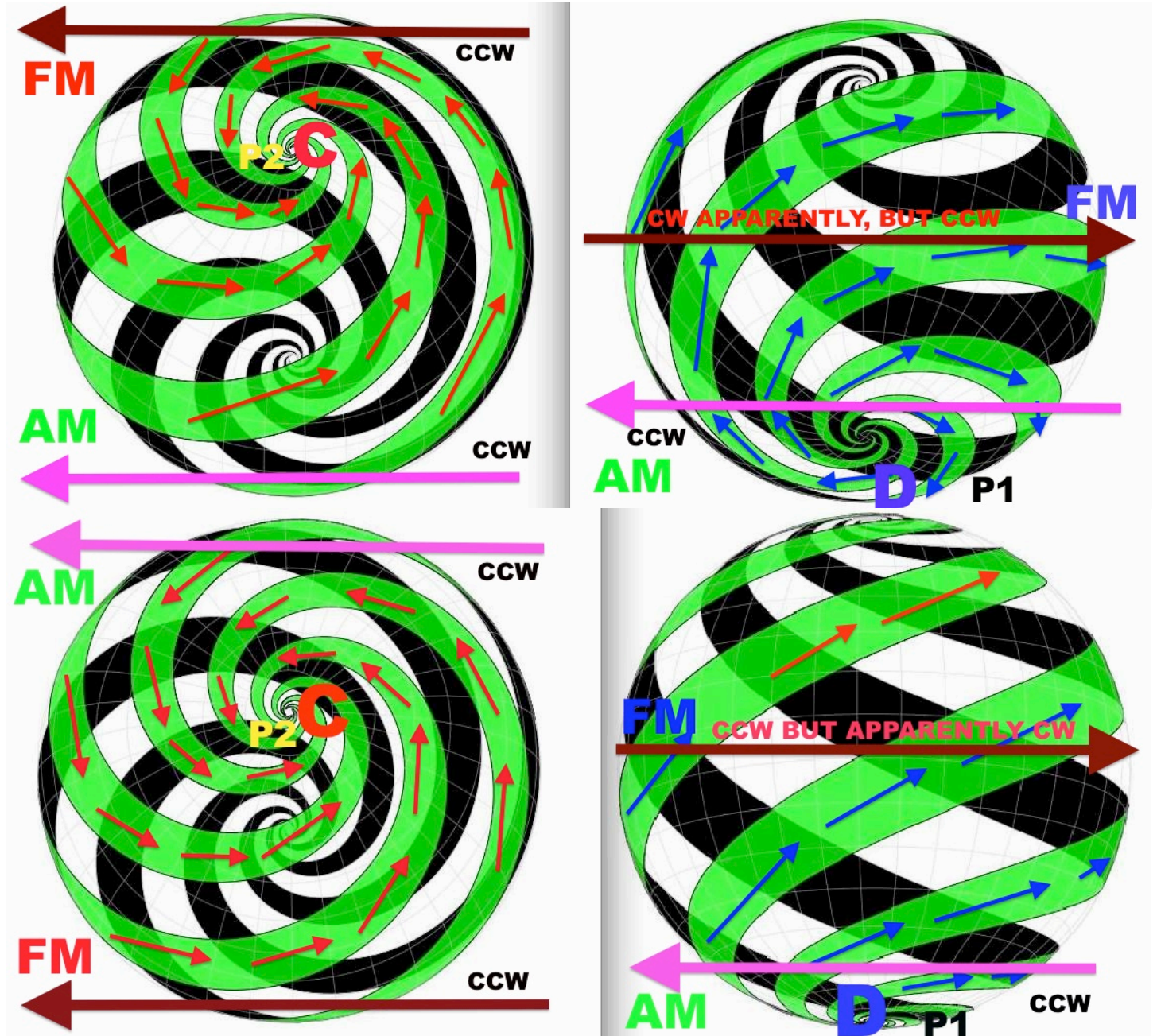

Magnetic attraction absolutely does not exist whatsoever. Forwarding the seemingly impossible but hyper-logical fact, which is evidenced by all observed phenomena, and understanding of the fundamental forces.

Below: Almost nothing is more primitive (and wrong) in the minds of men than that of 'magnetic attraction'. Only a few things are more primeval within the human consciousness than this, like the drive to reproduce, eat, and self-defense. No radiation of any variety can or may be permitted to attract anything. Such nonsense does not exist.

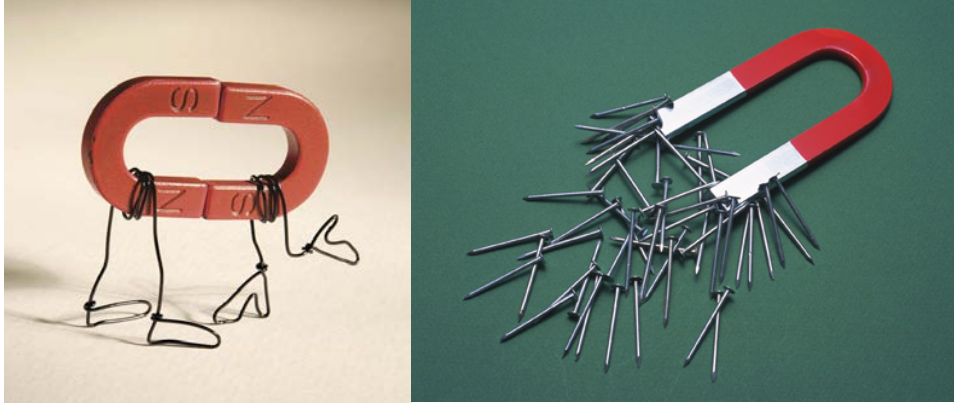

Radiation attracts nothing, never. It displaces dielectricity, and causes inductive coherency of the charge-state structure of the ferrous (or diamagnetic, or otherwise) object, which resultantly accelerates towards the inductive force (in the voidance of space) of counterspatial dielectric voidance, or what is conventionally and incorrectly deemed 'attraction'.

There is utterly no such thing as magnetic attraction; all acceleration (specifically movement) is dielectric voidance due to inertial coherency. Magnetism / radiation does not attract radiation, all such attraction or repulsion is dielectric voidance or counter voidance. Like on like polarity (space) is oppositional to dielectricity impetus for voiding the motional attribute of space.

What you yourself and everyone else refers to as "magnetic attraction" in fact is dielectric counterspatial voidance. It is as ancient as dirt (sic) as pertains the premise of the loadstone causing, from rest, acceleration of iron bits, nails etc. to the loadstone. As such there is very little in the world most deeply ingrained, and additionally, more wrong. The very term magic comes from the word for magnet. This 'invisible attraction', so deemed magnetism, and therefore "magnetic attraction" is an error, a perceptual defect and flaw; worse still, so-called 'experts' in academia, great regurgitators of well-established nonsense persist in spreading this outright falsehood.

Just like AC lines more voltage, the more dielectricity attraction (voidance) and the more the AC lines come together, this is dielectric voidance. Dielectric voidance is due to the dielectricity wanting to come into tighter counterspatial stasis, as is its nature. What others incorrectly call "magnetic attraction", is dielectric voidance. Dielectricity by nature is counterspatial and repelled by magnetic spatial fields, polarization, i.e. space itself which is definitionally movement in attributional creation from divergent magnetic fields.

Magnets (and AC lines) repel due to magnetism. The more magnetism in the AC lines the more it wants to push the wires apart, this is what is incorrectly thought of as "magnetic repulsion". It is dielectric counter-voidance.

What is 'reaching out' between objects, obviously so, is magnetism, however dielectric coherency and resultant acceleration cannot be said to be "magnetic attraction" rather resultant acceleration OF dielectric to dielectric due to magnetic displacement and induction of the object which accelerates to the so-called "magnet".

All phenomena affected by magnetism "at a distance" (which is not the case, since centrifugal polarized fields are already overlapping the affected medium or object), be it paramagnetic or diamagnetic is resultantly initiating dielectric coherency and movement into dielectric voidance, or dielectric repulsion (countervoidance, i.e. diamagnetic), as is the case with bismuth where the dielectric inertia is so high, and the magnetic reluctivity so high (also = extremely low magnetic permeability) that there is low reluctivity for polarized magnetic field permeability into the system or medium.

It is absolutely logical from the point of dielectric voidance and countervoidance to speak of any and all magnets as both "strongly diamagnetic and strongly paramagnetic". The effect known as 'magnetic repulsion' is governed by the fact of inverse dielectric voidance at which, rather than spatial voidance, there is space and movement introduced (like on like pole, N on N, or S on S) in which case it is accurate to say, that in this polarized configuration, there is extremely strong diamagnetic countervoidance ('repulsion') occurring; and likewise inverse to this scenario, (N on S, etc.) extremely strong paramagnetic voidance.

Diamagnetic bismuth's missing secret, and magnetic 'levitation' perfected using a 'programmed' bismuth discovery.

For the magnetic induction the Etheric relation is known as the magnetic "Permeability", for the dielectric induction the Etheric relation is known as the dielectric "Permittivity". – Eric P. Dollard

Bismuth sits at a golden ratio 'seat' on the periodic table, its dielectric inertia is so high, that its atomic radius of 143 is less than that of lightweight titanium which is 176, and less still the heavier polonium 190 and lead 154. It sits immediately between extremely toxic lead and thallium on one side, and extremely radioactive, extremely short-lived, astronomically rare and virtually non-existent polonium and astatine on the other side, of which less than 100 grams per year of polonium are created, and only created resultant to bombardment of bismuth with high energy protons and neutrons. While virtually four times the atomic mass of iron, it has an atomic radius of 143 to iron's 156. Bismuth like glass is a dielectric capacitor, however in the case of bismuth, it is extremely stable and resists ALL discharge to an extremely high degree, which is why its electrical conductivity and thermal conductivity are extremely low. However, as proven in nuclear reactor coolant use, its dielectric conductivity is nearly transparent. Neutrons are dielectrically dominant. Likewise this is why bismuth absorbs high energy gamma rays but allows the passage of neutrons.

Since this is a book on magnetism, why such a detailed focus on bismuth? Because bismuth is diamagnetic for the very same reason that the dielectric inertial plane of the "magnet" is anti-magnetic, is focused at, is forced at the centerpoint between polarities, not located at. Bismuth has just enough (very little) magnetism to maintain its spatial existence, which is also why its atomic radius is so low. One bit more of magnetism from an additional proton throws bismuth into chaos and hell as polonium. Bismuth cannot be polarized, it is the very least possible element to lose dielectric inertia in its atoms. This is extremely important beyond belief. There are unrealized properties of bismuth yet to be discovered. Bismuth's actual polarization is not polarization but turning it into polonium by attacking its nucleus; this however isn't polarization, but the creation of a radioactive and dangerous lethal beast.

Below: Nature's perfect example of dielectric inertia as represented in these anti-cube, or hypercube formation of bismuth crystalline formation. Pure bismuth under ideal conditions will easily reveal its nature; however horribly sad and odd that humanity has not grasped this glaring fact until now stated. While this is a book about magnetism, magnetism's initiator is dielectricity, which is counterspatial, radial, inertial, centripetal, and below you see a near perfect example of this expressed by pure bismuth crystalline formation. You cannot grasp magnetism without grasping dielectric inertia.

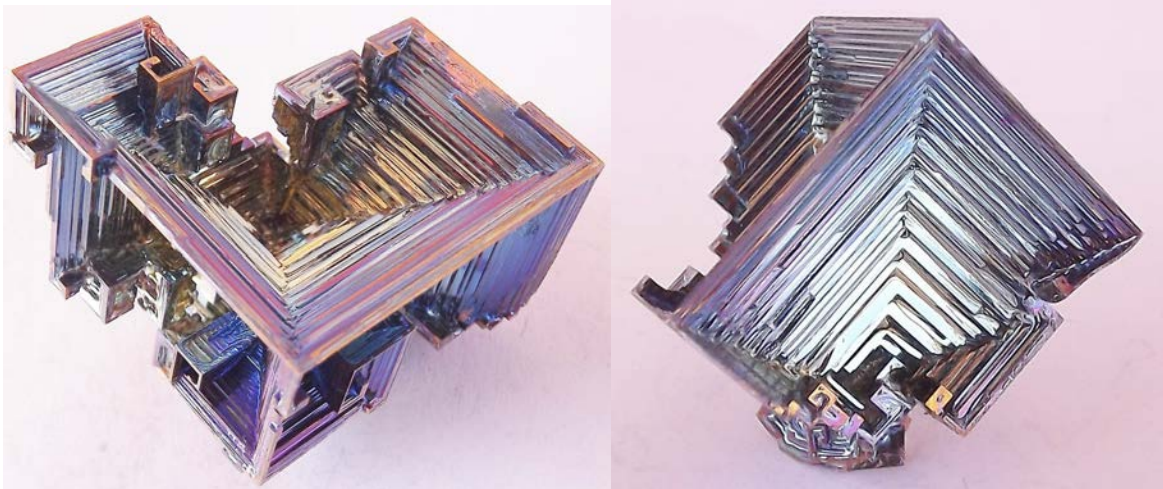

We must not speak about bismuth being 'diamagnetic', which it is, however it repels only centrifugal magnetism, not centripetal dielectricity. Bismuth's primary property is its incredibly high dielectric inertia, like a gyroscope spinning so incredibly fast that only destroying its nucleus will greatly alter its properties. This, until this writing, missing secret of bismuth will yield incredible invention in the very near future, at which time the price of bismuth will skyrocket. Given enough enormous dielectric charge applied to bismuth will create a hyperstate property of pure bismuth element with astounding level attributes and effects. In a simple but obtuse explanation, **bismuth is a dielectric dynamo, its own incredibly powerful dielectric inertia-well which contains yet unrealized enormous, enormous kinetic energy potential. Likewise with enough proton bombardment and incredibly powerful electrostatic charge, bismuth, by all calculations should be a nuclear-kinetic energy device with magnitudes higher energy output than input.**

Below: Lead and its genitor in radiative depletion, is Uranium; likewise the same for Plutonium which passes thru polonium into lead. However only Neptunium depletes into the heaviest stable element, bismuth. Uranium and Neptunium are the two primordial radioactive heavy elements of the universe; however Neptunium the far more rare in occurrence. Likewise the 9 parts per billion of bismuth is testament to this fact.

195.08 B2 fcc 1768.4 3825 21.45 2.28 78 2.4 Pt [Xe]4f ¹⁴ 5d ⁹ 6s ¹ Platinum	196.96654 A1/B1 fcc 1064.18 2856 19.31 2.54 79 1.3 Au [Xe]4f ¹⁴ 5d ¹⁰ 6s ¹ Gold	200.59 B2 rhm -38.83 356.73 13.546 2.00 80 1.2 Hg [Xe]4f ¹⁴ 5d ¹⁰ 6s ² Mercury	204.3833 B2 hcp 304 1473 11.85 2.04 81 1.3 Tl [Xe]4f ¹⁴ 5d ¹⁰ 6s ² p ¹ Thallium	207.2 A1/B1 fcc 327.46 1749 11.34 2.33 82 2.4 Pb [Xe]4f ¹⁴ 5d ¹⁰ 6s ² p ² Lead	208.98037 A2 rhm 271.40 1564 9.78 2.02 83 3.5 Bi [Xe]4f ¹⁴ 5d ¹⁰ 6s ² p ³ Bismuth	(208.9824) A1/B1 cub 254 962 9.196 2.0 84 2.4 Po [Xe]4f ¹⁴ 5d ¹⁰ 6s ² p ⁴ Polonium	(209.9871) — 302 337 — 2.2 85 ±1,3,5,7 At [Xe]4f ¹⁴ 5d ¹⁰ 6s ² p ⁵ Astatine
		238.0289 A1/B1 bcc 1135 4131 19.05±0.02 1.38 92 3,4,5,6 U [Rn]5f ³ 6d ¹ 7s ² Uranium	(237.0482) A1/B1 orth 644 — 20.45 1.36 93 3,4,5,6 Np [Rn]5f ⁴ 6d ¹ 7s ² Neptunium	(244.0642) A1/B1 mcl 640 3228 19.816 1.28 94 3,4,5,6 Pu [Rn]5f ⁶ 7s ² Plutonium			

Below: One proton separates heaven from hell, bismuth on the left and on the right, polonium. Stable bismuth with a half life of 20 billion billion years, non-toxic, safe, and the extra proton of polonium throws bismuth's dielectric inertia into chaos, (which is how polonium is created, by bombarding bismuth) so out of harmony that it becomes an extremely lethal tool of assassination and a short-lived deadly radioactive element where a millionth of a gram becomes fatal; likewise polonium is the initiator and nuclear trigger, along with beryllium, of an atomic bomb. There is a golden ratio balance between the protons and neutrons in Bismuth that will not ACCEPT A SINGLE ADDITIONAL PROTON without absolute chaos ensuing. This along with other evidentiary properties proves that bismuth has absolute dielectric inertia saturation, which explains its properties, explains its crystalline growth, explains its incredibly unstable nature when a mere single proton is added, explains its high diamagnetism. Dielectric inertia repels magnetism, pure and simple. Further below, bismuths spectrum absorption and emission has been a point of great study since it has dualistic properties dependent upon crystallization. Bismuth literally exists in a quasi-state of gravitational and inter-atomic spatial existence with inconsistent spectra emission and absorptions.

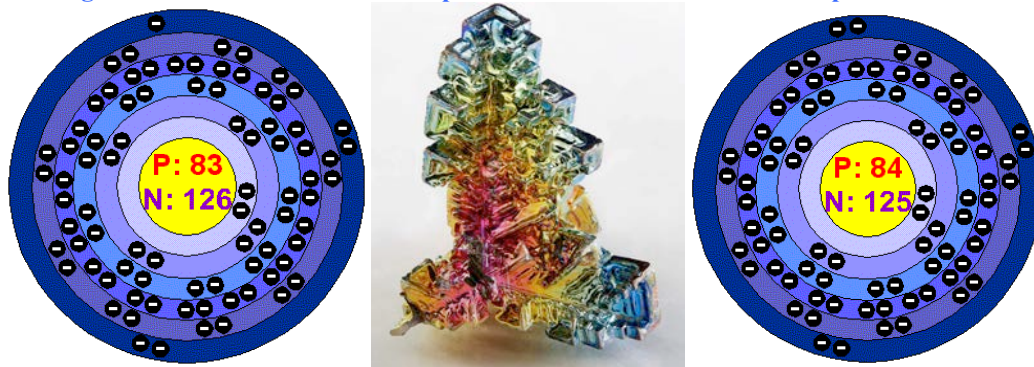

bismuth light signature

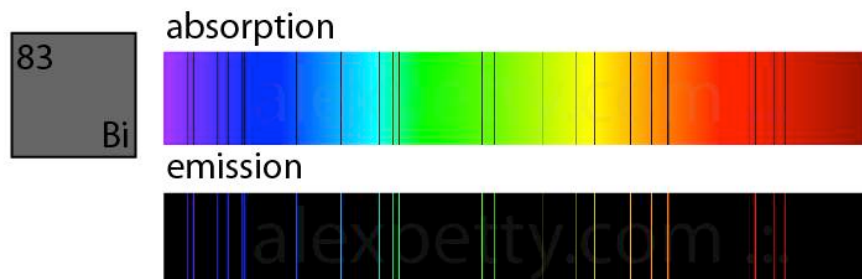

Bismuth is the HEAVIEST STABLE ELEMENT that exists in the universe. Everything else is unstable, radioactive and typically highly toxic, not to mention thallium and lead just below bismuth, it has an atomic weight of 209, although it has the atomic number 83. If you subtract the number of protons (83) from the number 209 (the atomic weight) you get 126. That is the exact number of neutrons in the bismuth atom. Since protons are magnetically dominant, merely adding one proton to bismuth to create polonium creates both an incredibly lethal, short lived, toxic and radioactive element that virtually does not exist in nature. Polonium when

inhaled or swallowed takes merely on millionth of a gram to be lethal. This is the very methodology used by Putin to murder Alexander Litvinenko. The Nuclear Gravitation Field Theory has to its premise that the “Strong Nuclear Force” and Dielectricity/ Gravity are one and the same force. Bismuth crystals grow extremely fast for a reason.

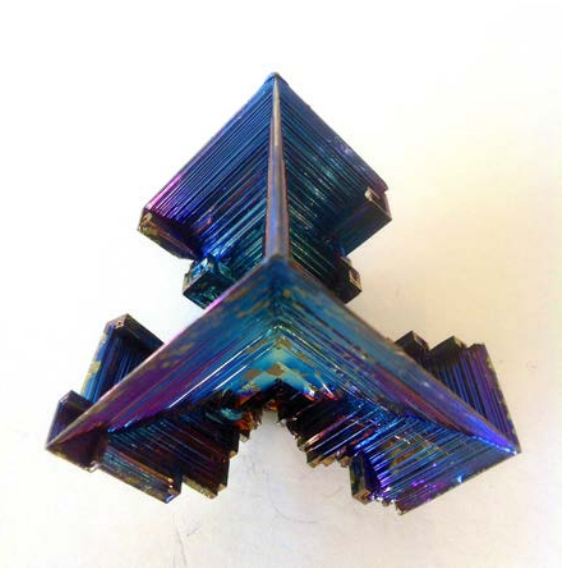
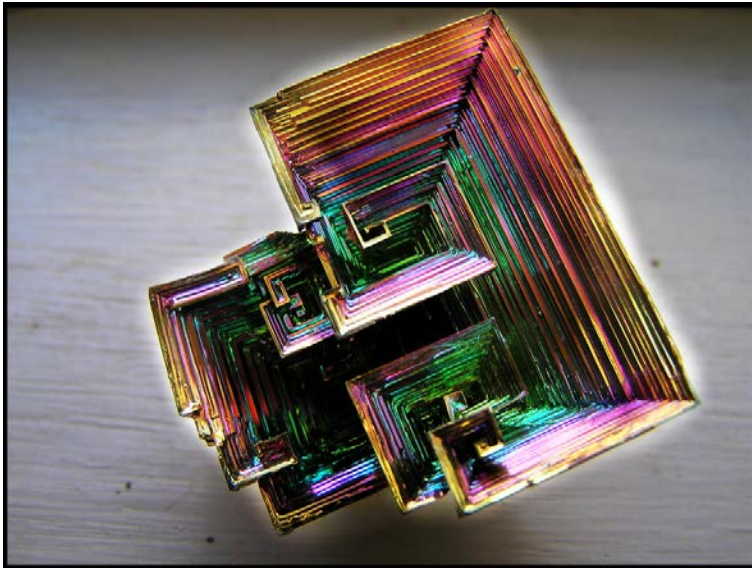

Typical investigation will not divulge the relative picture of bismuth, and its special ‘seat’ on the periodic table, being so unlike its neighbors. Resting between extremely toxic and incredibly rare and radioactive polonium with a mere handful of days of half life, and astatine with a mere 8 hour half life, bismuth is so stable that its half life is 20 billion billion years, infinitely longer than the calculated age of the universe, however this conclusion is spurious, since bismuth is entirely stable. Additionally, sitting on the periodic table, stable, non-toxic in its pure form, and so incredibly non-radioactive it is virtually inert denotatively, it rests between both the extreme incredible toxicity of lead and thallium, and the incredibly rare and worse still dangerous and unstable radioactive polonium and astatine. Thallium is so deadly, mere handling proves fatal and it was at one time used as a poisoning agent of animals and of murderers. Literally in the middle of hell and worse hell, is a safe and stable element with incredible dielectric properties some characteristics only recently being uncovered, one of which by myself in experimentation. Resultant to bismuths high dielectric inertia, it logically has extremely low magnetic permeability. All magnetic reluctivity is based upon dielectric inertia, a repulsion and resistance to magnetic field ‘breaking’ of inertia. Magnetism itself, being the dielectric field in discharge is definitionally a loss of Ether-inertia and represents the Ether-modality of magnetism, but denotatively this is the spatial vectorization of dielectricity due to its discharge /loss of inertia.

Below: On left, using my ‘programmed’ bismuth disk. Single disk levitation of 3mm N45 cube neodymium with 1” cube N50 5 inches above. On right identical setup using standard bismuth ‘non-programmed’ disk with same lifter magnet, with resultant much lower levitation. This is a wholly new discovery of bismuth casting with applied charge and field in casting.

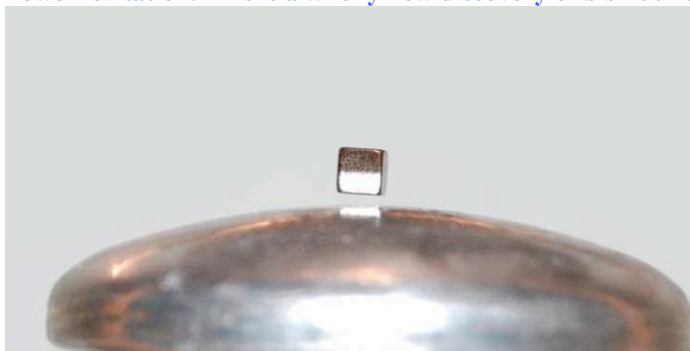

That bismuth is the only room temperature extremely diamagnetic element has gone over the heads of most people in its level of importance. Bismuth shrinks on melting, and expands on cooling, but its dielectric inertia resists any spatial divergence and likewise therefore grows hypercube crystals and forms golden ratio patterns of convergence when cast in convex formations. Any element or supercooled ceramic that becomes diamagnetic resultantly; it is the case that these objects have extremely high diamagnetism due to extremely high dielectric inertia, a low spatial footprint, and extremely low (the same thing ultimately) magnetic profiles. This is the reason for the very low atomic radius of bismuth, the reason for its attributes, the reason for its unique crystalline growth, the reason for its extremely high resistance to current and thermal conductivity.

Below: Beautiful Bismuth crystal grown by “Bismuth and Beyond” (bowers998 EBay).

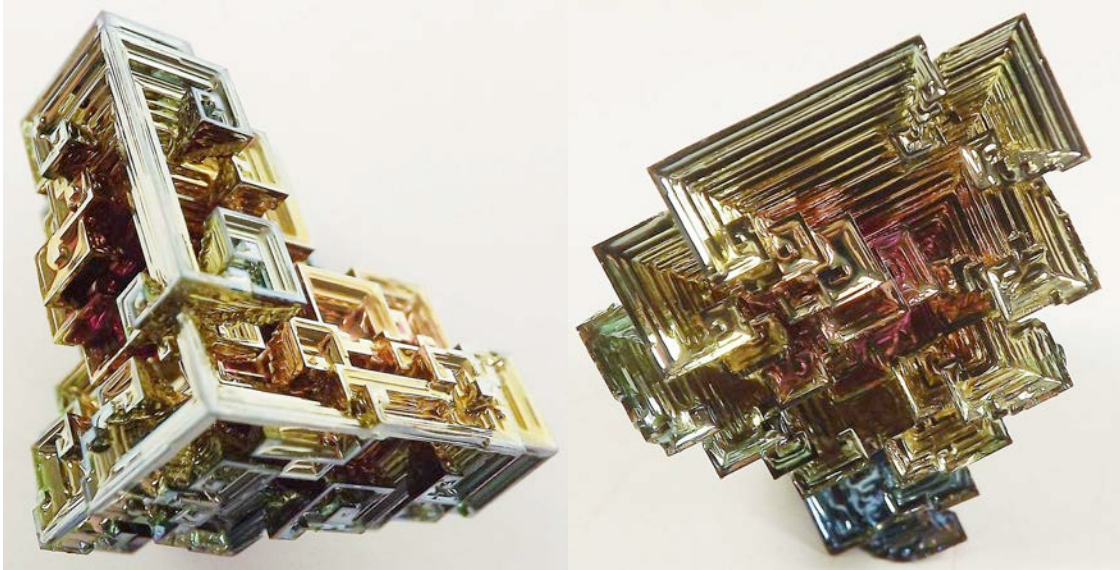

Likewise this property is seen in incorrectly deemed “superconductive” ceramics wherein which, under extreme cold the material obtains a super-state with an extremely small spatial (=magnetic) footprint which is filled by external magnetism causing them to act as one object regardless of the spaces between them, which are unreal to begin with. Fields mediate fields, and make no concessions or concerns for physical objective boundaries.

Artificially high dielectric inertia achieved in ceramics due to supercooling is naturally present in bismuth. The importance of this attribute has yet to be realized by the world. Likewise as I have discovered, the sandwiching of bismuth between layers of strong divergent magnetic layers has fascinating phenomena. That bismuth is the universe’s most heavy stable element with extremely stable properties and incredibly high dielectric inertia as seen in many of its attributes including its crystalline growth, means that bismuth in its liquid state is highly susceptible to gravimetric and magnetic influences of either voidance or countervoidance. Bismuth is literally an element possessing a high ‘urge’ to collapse itself into dielectric counterspace. This special property has yet to be exploited.

Below: On left, standard bismuth castings I built for superior magnetic levitation with greater stability which, using convex castings creates better stability to conform with the magnetic field geometry of both the lifter magnet and the levitator magnet (3mm small cube) as pictured on right.



Two examples of dielectric inertia

“All inherent inertia is centripetal, there are no exceptions; all centrifugal presumed inertia is not inherent and a resultant effect and only connotatively inertia, but not inertia definitionally” – Author

It has been unknown until now how normally cubic forming pyrite (iron) ‘dollar’ or ‘pyrite sun’ formations occur as found inside anthracite coal layers. Iron having both potential for magnetic permeability and dielectric permittivity can concentrate either and likewise therefore can form either high dielectrically radiant disk ‘star’ formations just as bismuth naturally does in a matter of a second upon cooling, or the iron can grow magnetic spatial cubes in formation depending upon the influences upon it in growth. Pyrite (iron) ‘dollars’ are the resultant of being grown under high dielectric inertia within tons of diamagnetic anthracite coal.

Below: Left is a pyrite dollar or “sun” in anthracite coal shale which is nearly 100% dielectric carbon which concentrates this dielectricity in formation in iron sulfide with both high dielectric permittivity and magnetic permeability. Rather than forming cubes or dodecahedrons these iron formations have grown under high dielectric coercion from millions of tons of surrounding dielectric carbon. On the right 99.99% pure bismuth naturally grown exactly like a “pyrite sun” on its own. Bismuth is, as we have much talked about, has the highest dielectric inertia of any element.



Below: Left picture is pyrite ‘dollar’ in its native anthracite coal shale which is diamagnetic carbon. On right identical dual pyrite ‘dollar’ formation intersecting at the known $1/\Phi^{-2}$ (.381966) and Φ (1.618033).



All heavy element roads terminate into lead, but only Neptunium ends in bismuth

Below: Left is a 1-pound ingot of pure 99.99% bismuth. On right is a two-piece cast experiment in pure bismuth. There is a 'secret' in the picture on the right that is wholly unrelated to the flash angle of the photograph taken. Both pieces of that image are pure bismuth.



Rarity:

Very common: LEAD = 14 parts per million in the earth's crust. COPPER = 60 parts per million in the earth's crust.

Moderately rare: SILVER = 75 parts per billion.

Extremely rare: BISMUTH = 9 parts per billion. GOLD = 4 parts per billion. PLATINUM = 5 parts per billion.

All indications are that bismuth does not exist natively whatsoever rather is the end product of depleted Neptunium.

likewise is the case that most lead is depleted uranium. Additionally current plentiful presence of uranium with virtually non-existent Neptunium is further indication of this. Neptunium eventually decays to form bismuth-209, unlike most other common heavy nuclei which decay into lead isotopes. Unlike most metals bismuth expands on cooling from its molten state. It is no coincidence nor anything other than perfectly logical that the first transuranic element, Neptunium degrades into the LAST heavy stable element, bismuth.

Below: Neptunium on the left and bismuth on the right. A loss of 10 protons and 18 neutrons is the termination into the most heavy stable element that exists.

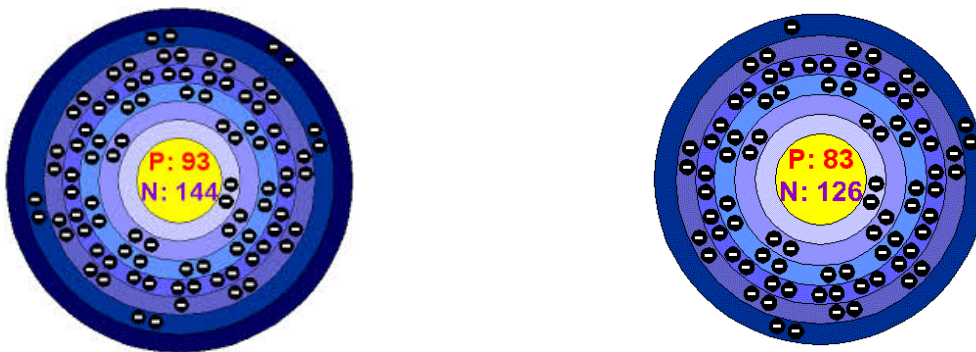

There are 81 stable elements in total. There are 83 elements, however, if we take out the unnatural elements, 43 technetium, and 61 promethium, because they do not occur in nature, we are left with 81 stable elements. One of these elements is hydrogen, the first in the Periodic Table, with an atomic number of 1. If we leave aside hydrogen we are left with 80 elements.

While you can read that "bismuth has a half-life of roughly 19,000,000,000,000,000 years", this is based upon a spurious test. What is fact is happening is a few stray neutrons exist in a very few atoms of bismuth of any grade, and this small bit is that of bismuth-210, which decays into polonium 210; polonium 210 is a very strong alpha particle emitter. Likewise there could be a very few atoms of polonium 209 with a half life of 102 years that are in the samples which decays into lead 205 via alpha radiation which was detected. Polonium is virtually non-existent in nature and one can more accurately call it a hyper-state of bismuth than innumerate polonium as a wholly different element.

As for the defunct experiment, the equipment used by the Orsay team consists of two "heat and light" detectors that are enclosed in a reflecting cavity and cooled to 20mk. The first detector- containing bismuth-209, germanium and oxygen – undergoes a slight temperature rise when it absorbs an alpha particle. This temperature change is measured in the form of a voltage pulse whose

amplitude is directly proportional to the energy released. The second detector, made from a thin disk of germanium, registers the light flashes from alpha-particle events.

The team performed two measurements, one with 31 grams of bismuth in the detector and the other with 62 grams. The scientists registered 128 alpha-particle events over 5 days and found an unexpected line in the spectrum at 3.14 MeV - now attributed to bismuth-209 decay. The half-life was calculated to be $(1.9 \pm 0.2) \times 10^{19}$ years, however this conclusion was based upon a false premise and understanding.

Henry Moseley's experiments [using X rays] demonstrated that what distinguishes one element from another is its atomic number, the number of protons in the nucleus of its atoms, not its atomic weight, which is a measure of the total number of protons and neutrons in the nucleus. The correct way of ordering the elements in the periodic table was, therefore, by their atomic number, and not, as Mendeleyev had thought, by their atomic weight. As for bismuth, it is stable with 43 extra neutrons, but with 42 or 44 neutrons it is unstable. This key point as per diamagnetism and stability cannot be overlooked. Bismuth also exhibits overunity since its 209 nucleus has a higher energy state than the sum of its components, which would be of thallium 205 and helium-4 nucleus. Meaning bismuth breaks the rule of conservation.

The thorium series begins with thorium-232 and ends with the stable nuclide lead-208. The neptunium series is named for its longest-lived member, neptunium-237; it ends with bismuth-209. The uranium series begins with uranium-238 and ends with lead-206. The actinium series, named for its first-discovered member, actinium-227, begins with uranium-235 and ends with lead-207.

Meaning 'all roads end in lead', except for neptunium which ends in bismuth! From this we can deduce that of lead we know it is naturally very abundant however almost all of it is the product of long-term uranium depletion; whereas neptunium is the only element that degrades into a non-toxic hyper-stable element, bismuth which is likewise on par with gold and platinum in rarity. Uranium degrades into lead, and neptunium into bismuth. Both neptunium and bismuth are extremely rare, all natively existent neptunium that was present at the formation of the earth has since degraded into bismuth, that it exists alongside lead in mining is no coincidence since neptunium is found alongside uranium as well naturally however it is extremely rare. The universe's rarest heavy unstable element degrades into the universe's rarest and most heavy stable element bismuth.

Below: Thorium decay series, Uranium (dual) decay series, and lastly the neptunium radioactive decay series which terminates into bismuth.

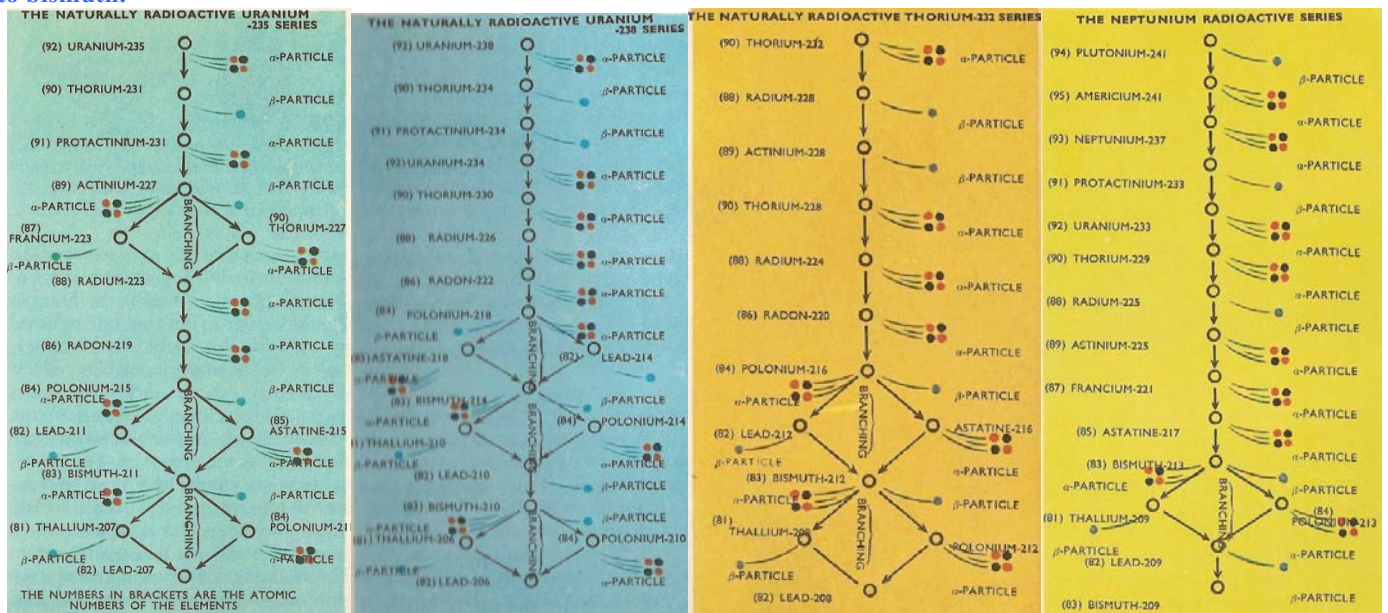

Spatial cubes and counterspatial dielectric-inertia bismuth 'anti-cubes'. Space & Counterspace part II

Below: Anti-cubes, hypercubes, and counterspatial dielectric inertia formations.

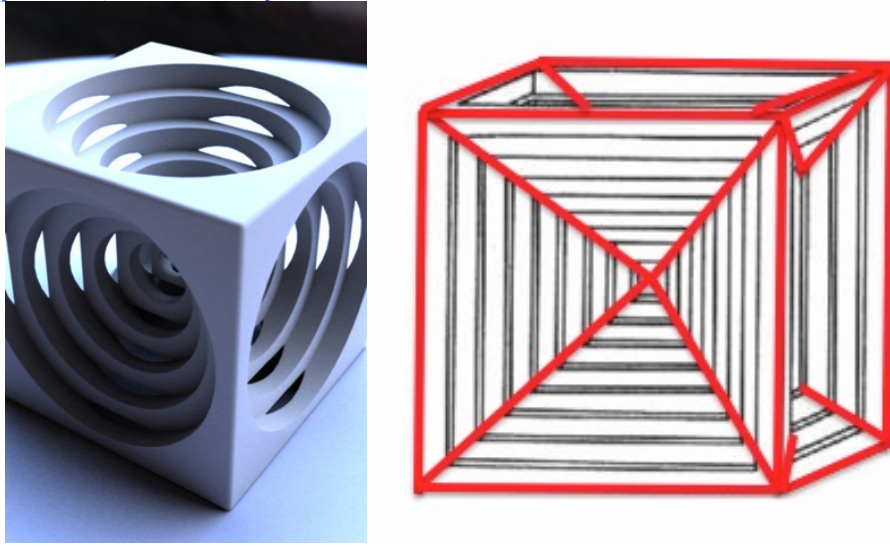

Below: Left, space, and middle counterspace, not 'warped space' ala Einstein who, in stupidity reified space as something, rather counterspace. "Since action and reaction are coexistent, it follows that the supposed curvature of space (ala Einstein) is entirely impossible" – Nikola Tesla. "To say that in the presence of large bodies space becomes curved is equivalent to stating that something can act upon nothing" – Nikola Tesla. Far right is an inertial anti-cube in which decreasing dielectric inertia is retains up until the center of the cube.

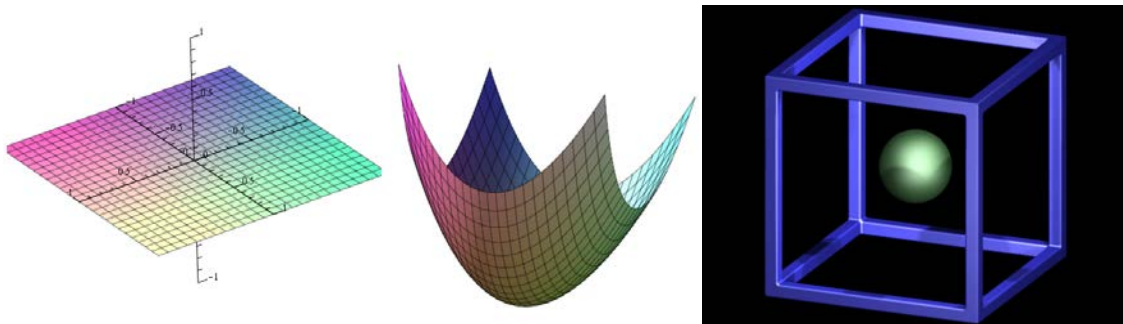

Ultimately I have spoken much about polarization, i.e. space, and likewise dielectric inertia, or counterspace. But do we have any stark examples of this in nature? The answer is many, yes. Taking the element most prone to spatial polarization (remembering that space = 4, i.e. the cube [monas, nous, chaos, hyle]), that being iron, as contrasted with that of bismuth, with a high neutron count (dielectrically dominant) and the highest elemental dielectric inertia present. Both present themselves under ideal crystalline growth, with spatial (in the case of iron) and counterspatial (in the case of bismuth, denotatively described as 'hopper crystallization', however this is descriptive, and is not explicative!) crystalline growth.

Below: Multiple concave bismuth castings reveal what was logically to be predicted from extremely high dielectric inertia, anti-growth centripetal patterns at 137.5077, 137.5077, and 85 degrees. Extremely large concave intent voids left in material at these specific golden ratio angles. Logically so but inverse, likewise patterns from magnetic radiation resultant from magnetic divergence are seen and in gyromagnetic precessional frequencies of reciprocation.

MULTIPLE CASTS, SAME RESULT. HIGH DIELECTRIC INERTIA IMPRINTS GOLDEN RATIO MARKS ON THE CAST. THIS IS COMMON TO GROWTH IN ALL LIVING MATTER, AND PREDICTED TO EXIST IN DIELECTRIC INERTIA. NOW CONFIRMED

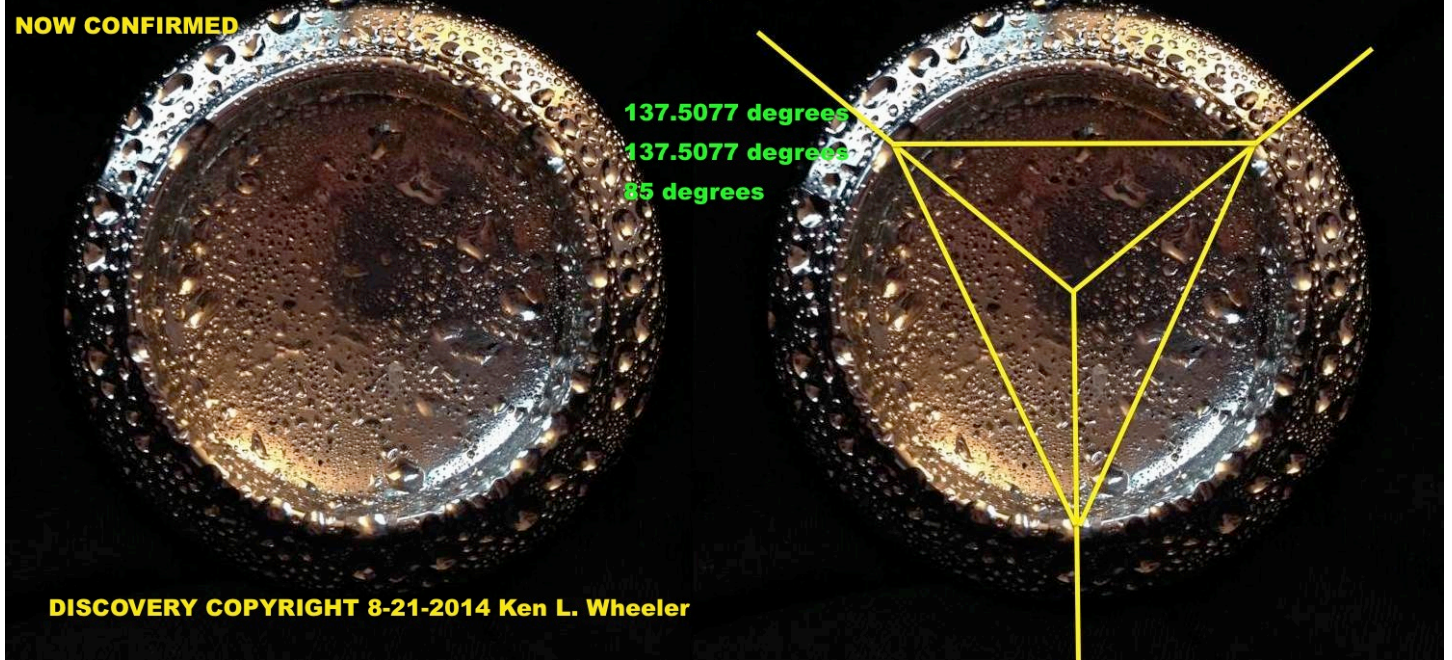

Below: Bismuth disk pours which always end their cooling cycle in maintaining their dielectric inertia by raising a small bump in the center, ever-resisting solidification and seeking counterspatial formations. Likewise you can see this as evidenced by the concentric shrinking circles formed in their cooling around the entire circumference.

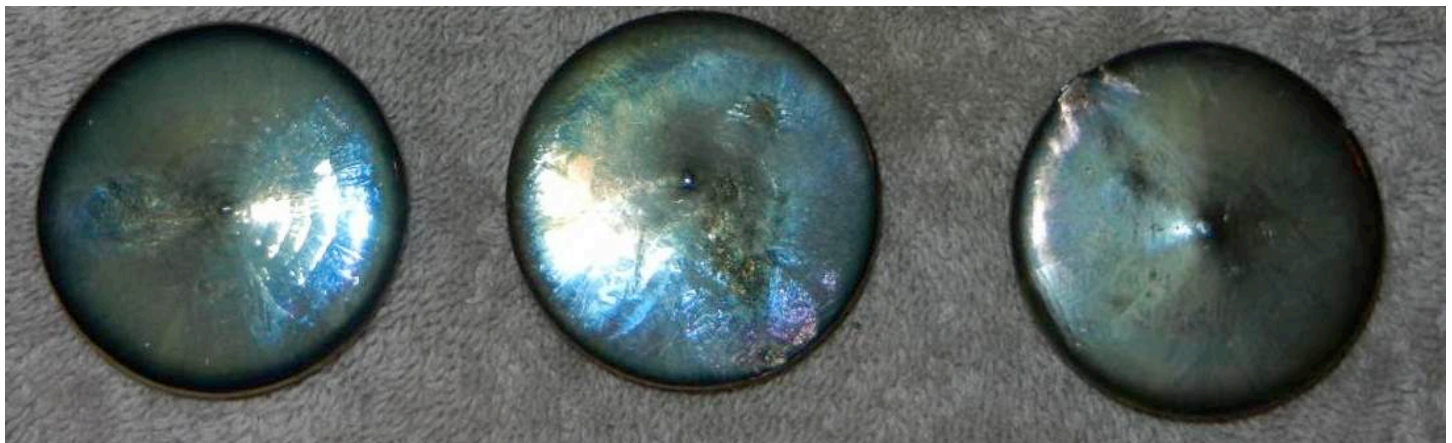

Obviously and logically so, bismuth the heavy stable element that it is must form spatial blobs or crystals if allowed to cool on its own; however if grown correcting during cooling and the excess poured off, fantastical counterspatial crystalline growth is seen; sometimes the forming (see pictures below) of perfect 'anti-cubes'. This "hopping" has not been understood until now. It is incorrectly stated that this formation of bismuth is due to 'electrical attraction being higher at the edge of the crystal growth', but this is absolutely not the case. This formation is appropriately to be deemed a 'hypercube', or counterspatial tesseract. This growth is due to dielectric inertia inherent to pure bismuth.

Below: From the book 'De Divina Proportione' (About the divine proportions [the golden ratio]) by Luca Pacioli 1509. The book was illustrated by Leonardo da Vinci. On the left (SOLIDUS) you can see a cube of space, and on the right (VACUUS), an anti-cube, a dielectric anti-cube, or counterspace, hypercube, or Ether-tesseract, or inverse-space, or 'negative-space'. Dielectricity is counterspace. Only two copies exist of this work. That this very illustration is from the hand of Leonardo da Vinci himself is no coincidence as pertains his interest in it. This work is, as yet, untranslated into English. Only two copies exist and thankfully it has been digitized for a future translation.

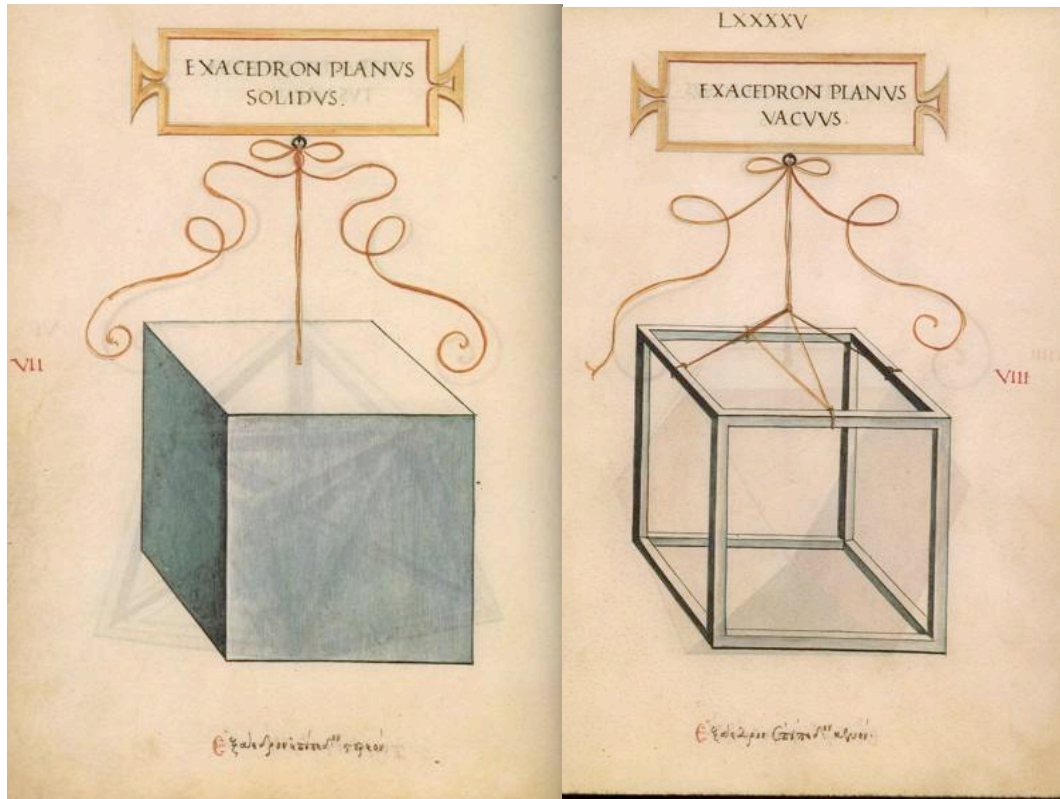

Not only are bismuth crystals extremely fast growing (due to dielectric inertia), but their crystalline growth (from a genuine electro-mechanical standpoint) is perfectly understood if one knows the conjugate nature of dielectricity and magnetism and how both or either can dominate a circuit, a system, or even crystalline growth wherein you have two antinomies, iron (spatial, polarized from induction), and its antithesis, bismuth (counterspatial, inertial, dielectric, radial [as seen in the sharp 90 degree line and inwardly curling formations of bismuth]). Alas and unfortunately, not until the writing of this book has someone with a full grasp of dielectric and magnetic theory and understanding taken an intelligent look at how magnetism and (in the case of bismuth) dielectric inertia play an extremely heavy role in the formation of crystalline growth. Bismuth has extremely high (the highest) dielectric permittivity and extremely low magnetic permeability.

Below: Shown dielectric curling of the extremely high electrostatic inertia inherent to the nature and pure bismuth crystalline growth as formed in cooling crystalline growth.

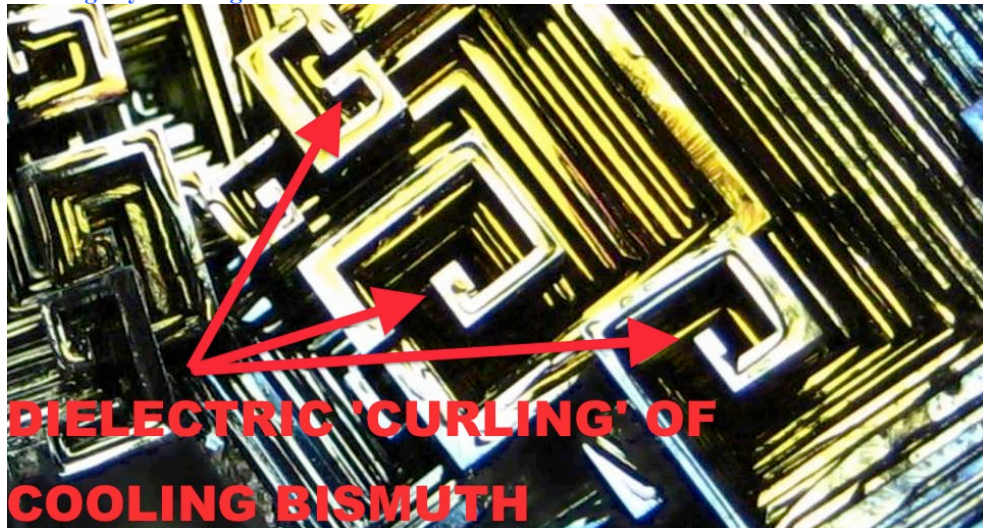

The dielectric nature of bismuth is also why bismuth has an extremely low melting point, its dielectric inertia is already enormous and takes a low heat to bring it to the melting point. All bismuth crystalline growth is due to counterspatial dielectric inertia at which (as amply demonstrated) cooling is not only from the outside in (as inertia would necessitate), but likewise and importantly cools in a geometric negative-space 'stepped' pattern, either in full anti-cubes, or partial anti-cubes which appear pyramidal. Likewise you can see this inward inertial 'curling' on virtually all bismuth crystallization. Apparently it takes a Platonic retroductionist to tell the world something (which to myself) that is so extremely and obnoxiously obvious that it virtually screams the 'answer' to its growth matrix.

Below: As necessitated, during cooling, counter-vortex (CW and CCW) counterspatial curlings will occur on every plane of cooling for molten metal trapped by cooling from forming the perfect anti-cube. **This formation of inverse centripetal curl is both necessitated, absolutely logical and deducible by simplex comprehension of dielectric inertia** (of which extremely few are studied in). Dielectric inertia is written about much by the great masters of electrical engineering who gave us 100% of our electrical system of today, that being Faraday, Maxwell, C.P. Steinmetz, Nikola Tesla, and Oliver Heaviside.

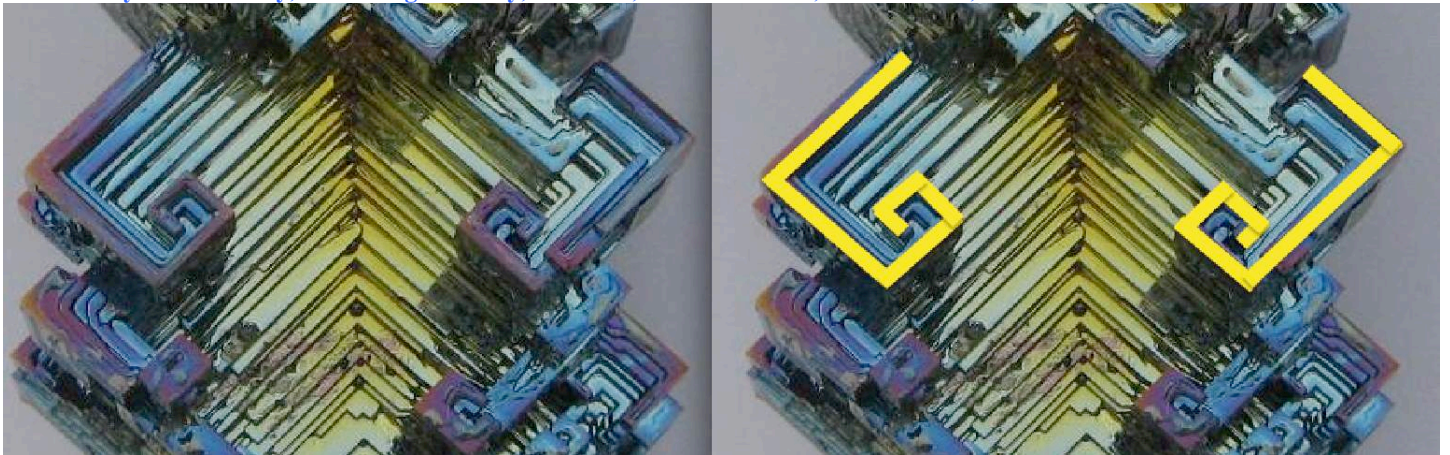

Below: Shown left, spatial **iron-pyrite cube**, in line with its magnetic polarization growth-matrix in crystallization. Middle picture is a dielectric counterspatial **'anti-cube'** of bismuth, a **'hypercube'**, or **counterspatial tesseract**. Bismuth has extremely high (the highest) dielectric permittivity and extremely low magnetic permeability. Oddly, depending on how you look at the bismuth in the middle picture, some will see an anti-cube, and others have mistakenly thought it a pyramidal formation. This is typical optical phenomena of negative-space, or counterspatial phenomena. **Far right, likewise without coincidence, this is the very same dielectric counterspatial 'sink' as seen on the centripetal zone of a cube (or disk or otherwise) magnet as seen under a ferrocell. Dielectricity always expresses itself in a counterspatial phenomena. Usually (almost always) never recognized by the unintelligent manyfolk, the layman, who is unskilled in Euclidean geometry and Platonic logic.**

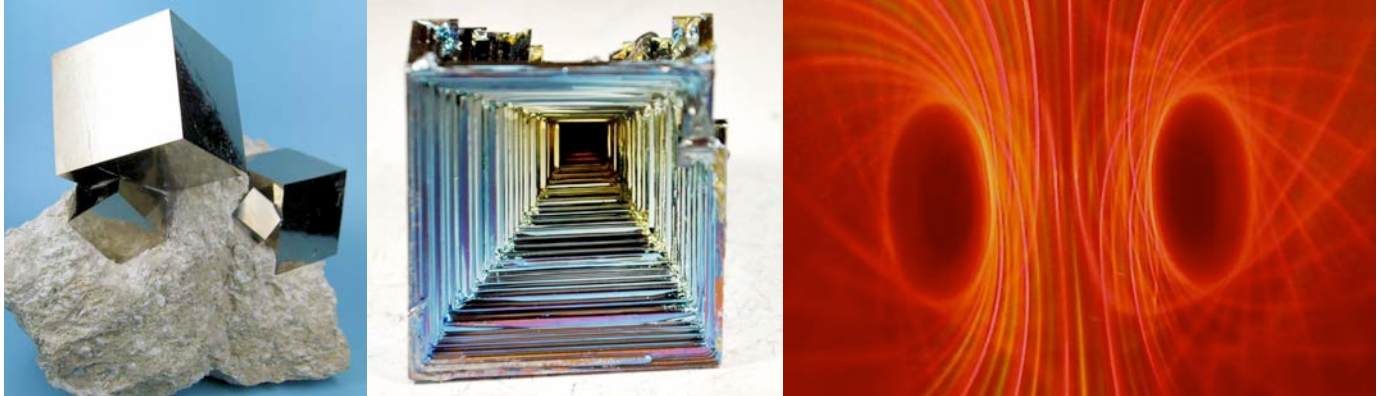

It is often stated (almost always) that “bismuth is diamagnetic”, but this is a posterior property to its dielectric nature. Diamagnetic properties are always posterior attributes or properties to a prior electrostatic or dielectric inertia state which resultantly is therefore also ‘diamagnetic’. Instead of saying “bismuth is diamagnetic” it is more accurate to fundamentally state that bismuth is supra-dielectric; has extremely strong dielectric inertia to the pure innate element. ‘Diamagnetic’ means nothing ultimately as per bismuth than as a posterior attribute to the dielectric elemental bismuth; rather it must be pointed out that the universe’s most diamagnetic element is only thus because it has extremely high dielectric inertia, which as we know already from the book is centripetal, counterspatial, and radial. Bismuth is diamagnetic resultantly, but as per bismuth we must declare its innate property first, which is a high neutron count and stable high-dielectric inertia element which necessitatively must form anti-cubic, counterspatial crystalline formations; a ‘hypercube’, or counterspatial tesseract.

Below: Likewise again, a perfect example of spatial polarization of the innate iron cube as representative of magnetic permeability, and its antithesis on the right, a bismuth inertial, dielectric **'anti-cube'**, representative of counterspace and inertia in general, as some have deemed this formation, a **'hypercube'**, or **counterspatial tesseract**. **Literally a dielectric anti-cube is an inertia convergent centripetal, radial (subtractive) hypercube**, whereas its antithesis, the iron cube is a spatial, reciprocating (additive), divergent, centrifugal cube.



Amusingly, however absolutely true, I have just informed you the reader, and the world that bismuth has an extremely unique set of characteristics in that it not only contains the highest primordial Ether-modality (dielectric) concentration of dielectricity (and resultantly is therefore extremely diamagnetic), but that its lovely crystalline formations are counterspatial, or anti-cubic, are negative-

space, or hyperspatial in nature. If the new-ager community catches word of this, bismuth crystals will start flying off the shelf resultant to this logical revelation and dielectro-crystalline discovery. Likewise that bismuth is extremely miniscule in radioactivity, with a half-life countless time longer than the age of the universe itself. Bismuth is estimated to have a radioactive half-life of 20 billion-billion years, but this calculation is false.

Below: Warped space is the product of the warped mind of Einstein, it does not exist and Nikola Tesla was right to run it out of town on a rail. Counterspace as per gravity is centripetal dielectric inertial acceleration, pure and simple. As per the Poincare' adapted model of extreme compression charge, all matter is the product of dielectric accretions as formed in cosmic structures in mass, and they themselves were formed from the G.U.T. of $1/\Phi^3$.

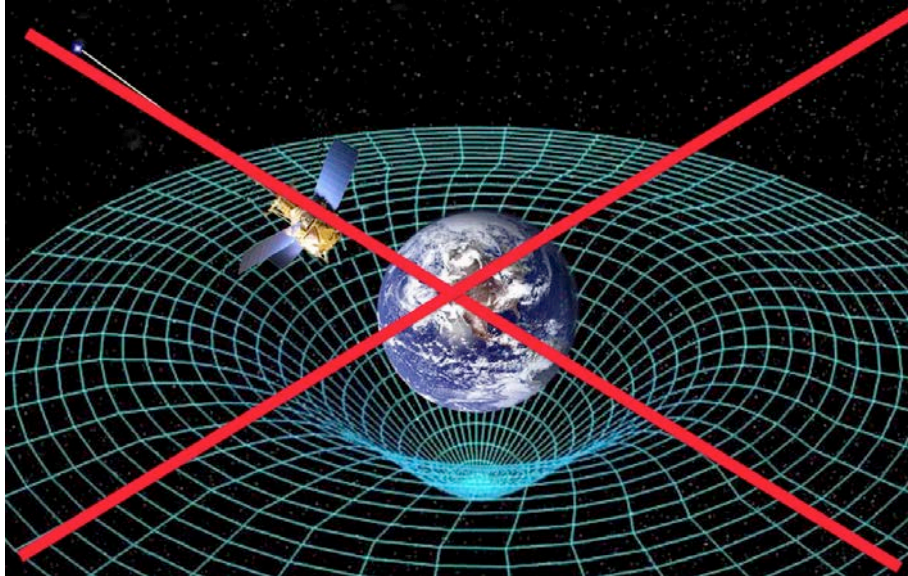

Below: Left, a 'hypercube', or **counterspatial tesseract** which decreases its spatial footprint in accordance with dielectric inertia as its cools inwards and retaining as much inertia as possible while molten. On the right, while only a partial anti-cube, the resultant formation. Dependent upon cooling rates and conditions, the peripheral inwards curling is the bismuths missing (increasingly so) attempts to retain dielectric inertia as it cools. **A genuine dielectric counterspatial tesseract only has 12 'anti-facets' or 'anti-sides', not 24, since several facets complete other 'sides' faces/facets.** Whereas a spatial cube has 6 faces it only has 4 sides necessary to delineate a cube, an 'anti-cube' has 12 'faces' but only 1 'side' that being inertia, the dielectric Ether. Meaning a dielectric anti-cube has twice as many 'faces' as a spatial cube, but only requires 1 side compared to 4 of a cube; implying counterspace contains both (expressed by potential of inertia in discharge, i.e. magnetism = polarization = space) space and counterspace (6 and 6) all contained within one 'side', dielectric inertia, within which the dielectric/ Ether-inertia is complete. This line of reasoning is wholly 100% Pythagorean & Platonic logic. However the very premise of the tesseract is that it has 12 facets but only one apex or true 'corner', a counterspatial null-point, as both meant and implied the Ether itself. **Herein we have 12 faces and 1 side of an anti-cube, and 6 faces and 4 sides of a cube, 13 total and 10 total respectively,** however 10 and 13 are both expressed wholly by 1 ($1/\Phi^3$, the G.U.T.). 13 is the first expression of the golden section outside of 10 (1,1,2,3,5,8,13), and 1 of course its first. 4 the square, and the cube (likewise of course 6), or space (polarization) does not exist in the golden section for good reason, space is wholly unreal, it is a radiative abstraction of charge in discharge.

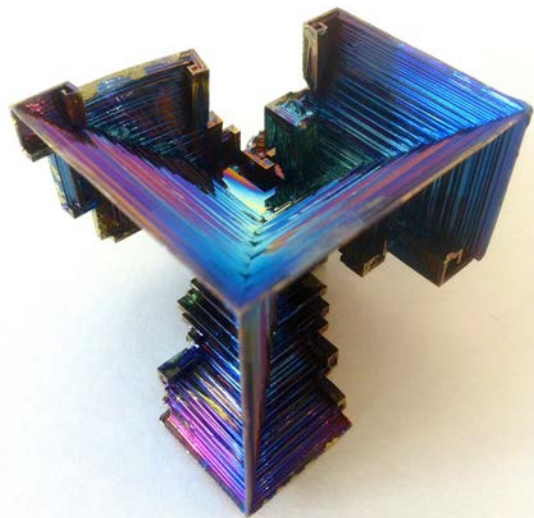
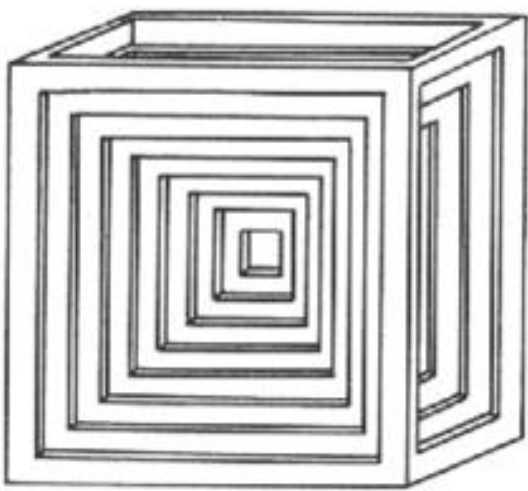

In closing, we can say that while much descriptions existed about hopping and bismuth hopping, there were absolutely no explanations until now. As is the case of anything with inertia, especially dielectric inertia as present in a metal in molten form, it will retain that inertia from the lowest potential outwards to the highest inertia inwards in which it expresses its dielectric inertia, and this is both how and why bismuth creates counterspatial crystalline formations if allowed to form under perfect conditions. This has been, ineptly and wrongly, described by some as "unnatural *angular crystals*", but it is in reality 100% natural and perfectly in league with anyone who understands dielectric inertia.

The τέσσερεις ακτίνες, translated as four rays, the tesseract is the cross of and between both space (magnetism) and counterspace (dielectric). The first number to be absent in the golden section being the cross, or the number four. The corner of ever cube is the intersection of 3 lines and four the convergence or collapse of space into counterspace, or the face of space, being four, the square, and likewise the cube 6, the second number not to exist in the golden ratio. Counterspace defines space in discharge, or divergence, and in posterior space gives a referent to counterspace in convergence, or centripetal voidance of a discharge undergoing convergence. Space is the divergent remainder of counterspace in loss of its inertia in distension from its Ether fulcrum at which point we differentiate this Ether modality as magnetism. Hence we then have 4 and 6, space (Khaos, Xaos, matter, Chaos) and excess (6, excessius Latin). Obviously so, all logical branches of pure Platonic metaphysics has the lowest consideration for both excess and Xaos, however obviously so necessitated (ananke).

Below: On the left, a perfect example of intersecting spatially polarized iron cubes superimposing in growth upon one another. On the right a partial though near-perfect example of a counterspatial dielectric 'anti-cube' of bismuth.

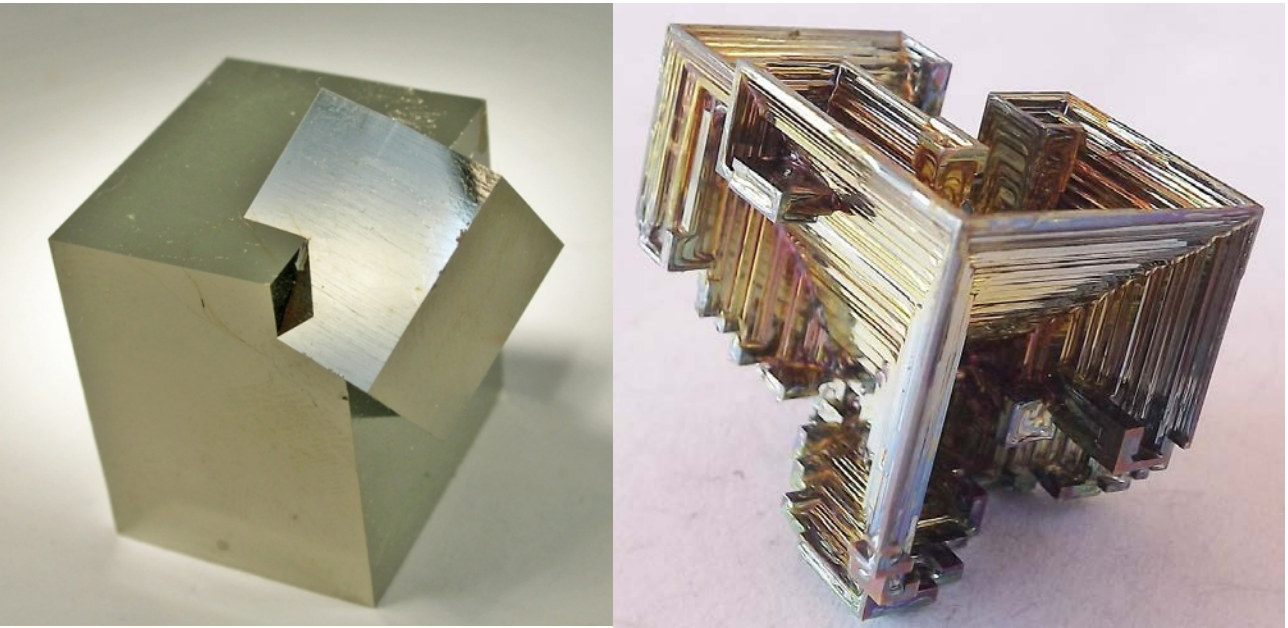

Below: A perfect example of a bismuth anti-cube, or hypercube, with a smaller cube intersecting the larger during formation wherein which dielectric inertia forms these centripetal "hopper crystal" formations.

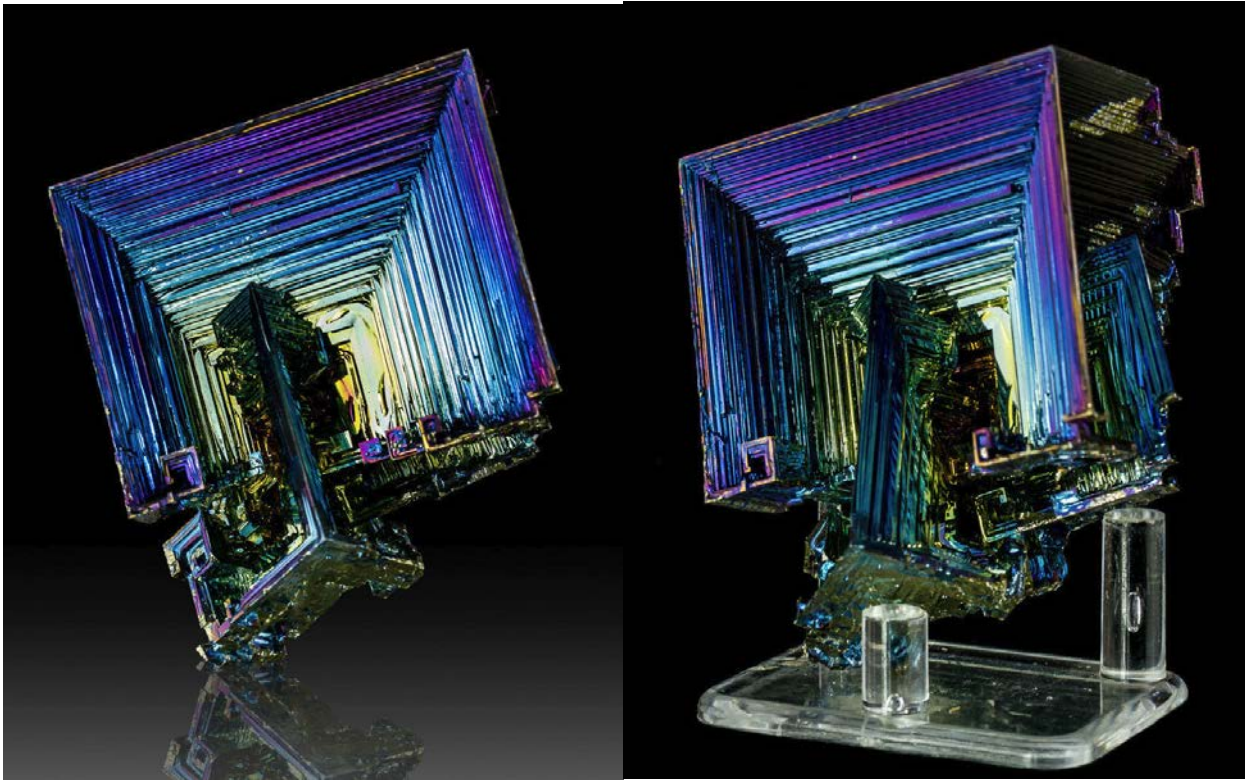

Below: Tiny hypercube natural formations as found in nature. This growth is driven by dielectrics, can only be driven by dielectric inertia crystallization.

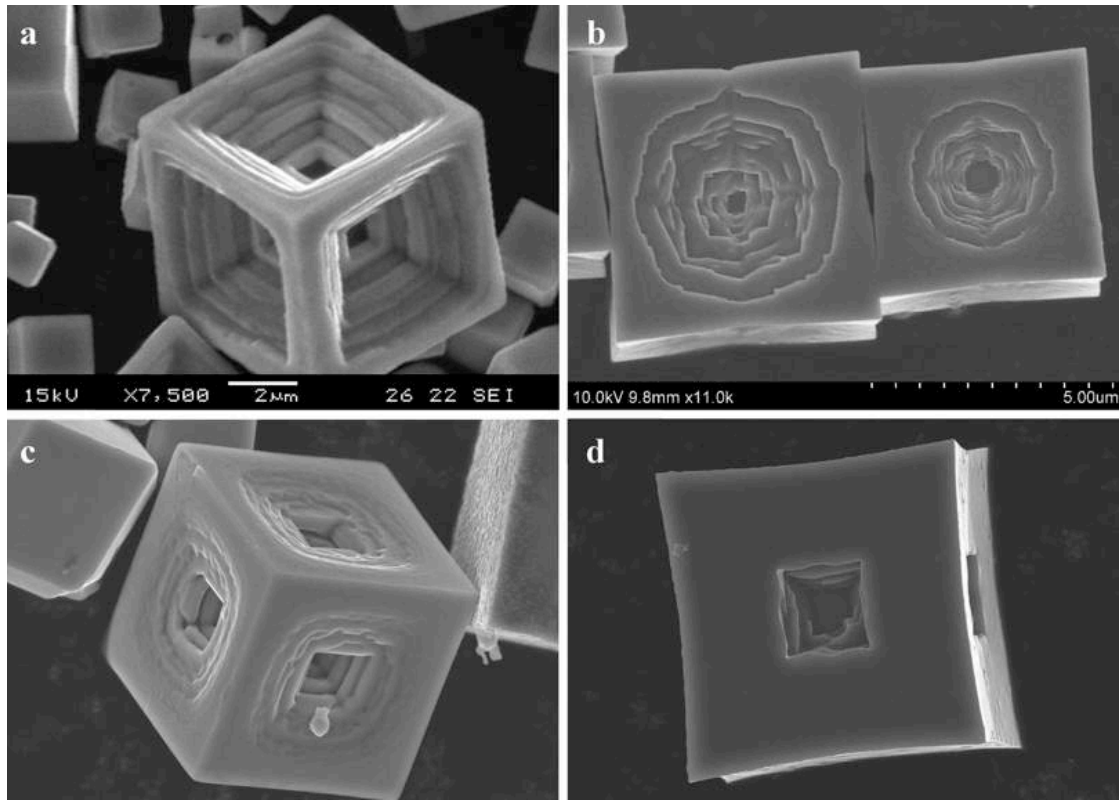

The magneto-dielectric hyperboloid, or defining field inertia vs. magnetism / space / movement

What is the magneto-dielectric system of the magnet? It is a magneto-dielectric hyperboloid multi-spatial system (space and counterspace, or as meant magnetic and dielectric) and follows the Poincare' disk model. The hyperboloid polarized stereographic projection (i.e. magnetism) is $=1$ and $=0$, likewise the dielectric disk is $=0$ and additionally $=1$. Explaining this fact to the conventional mind however is not an easy task. The projection is empirically real, but a 0-projection, the dielectric inertia is fundamentally real and 1, but has a 0 quantity factor since it is counterspatial inertia, pure potential. – Author

Fundamentally it is easiest to remember the **three H's**. The magneto-dielectric system is a hyperboloid, which is preceded by a hyperbolic disk of dielectric inertia, which creates the hyperboloid formation, which is the 'magnet'. Lastly the reciprocating magnetism creates a hypotrochoid ('spirograph'-like) of divergent and convergent pressure mediation. **Hyperbolic disk**, the magneto-dielectric **hyperboloid**, and lastly the vectorized **hypotrochoid** formation. - Author

**NOW, WE MUST
ANSWER:
WHY DOES
DIELECTRICITY
DIVERGE IN DISCHARGE.
WHY MUST MAGNETISM
RECIPROCATE RATHER
THAN, LIKE OTHER
RADIATION, JUST "GO
OUT" AND NOT RETURN**



Newton's first law says: "Every body tends to continue in its state of rest or uniform motion in a straight line unless it is acted upon by an outside force". This statement of Newton's is untrue however on many levels, no body of mass and matter is ever at rest, definitionally this is insanity to state as much. All bodies are moving curvilinear relative to one or more planes of inertia, local, galactic or otherwise. Field pressure mediation is not a force, nor is it 'outside' except in the case of divergent magnetic fields which have spatial vectorization as they are so defined. Likewise there exist no straight lines of motion, only spiral or curvilinear motion relative to a null fulcrum. Likewise further, as in the case of iron accelerating from rest in the presence of a dielectric field of voidance (i.e. the 'magnet') this is not a force at all, but a field voidance of space which is the attributional byproduct of magnetic fields. A physical force of pushing or pulling is wholly unrelated to field voidances or countervoidance. A field is not a force, instantaneous motion in dielectric voidance is not an empirical force of one body acting upon another by either contact or empirical coercion; rather is a field voidance of increasing movement towards dielectric inertia which is the cancelation of said movement in a shrinking sphere of space which is definitionally a polarized sphere of movement created from one or more spatially divergent in creation (past tense) magnetic field dominances. A increasingly moving body is losing inertia, never gaining it.

Below: When the divergent hyperboloid curvature matches the disk curvature, this is the maximum magnetic divergence, at which point convergence begins to occur. Respective to the image on left, the right side divergence forms one stereographic magnetic divergent projection (clockwise), and the left side forms an inverse stereographic magnetic divergent projection (counterclockwise) in the other polarized spatial vectorization. Any line that passes thru the center is $=1$ and $=0$, having both infinite inertia and 0 radius, all outside of this is discharge and divergence, is magnetism and the creation of space. Magnets and magnetism operate off the infinite Ether inertia of dimensional discharge, the loss of dielectric inertia which then becomes the Ether modality known as magnetism. Image on right, only three infinite rays or radius can intersect the center of dielectric inertia, this formula is the expression of my discovery of $1/\Phi^3$, wherein the necessitated loss of dielectric inertia in divergence = .23606 as against 1, which = Φ^3 , or Phi cubed. Likewise these three rays form the Pythagorean incommensurability of the 1-1-Phi triangle of the perfect extrapolation of inertia in discharge and mutual harmonic conservation.

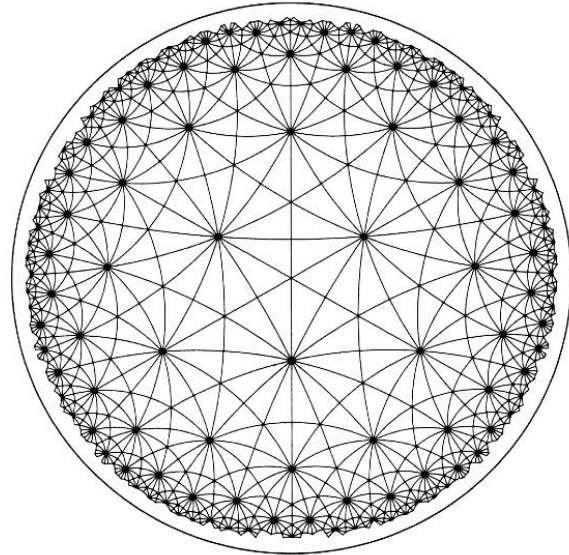
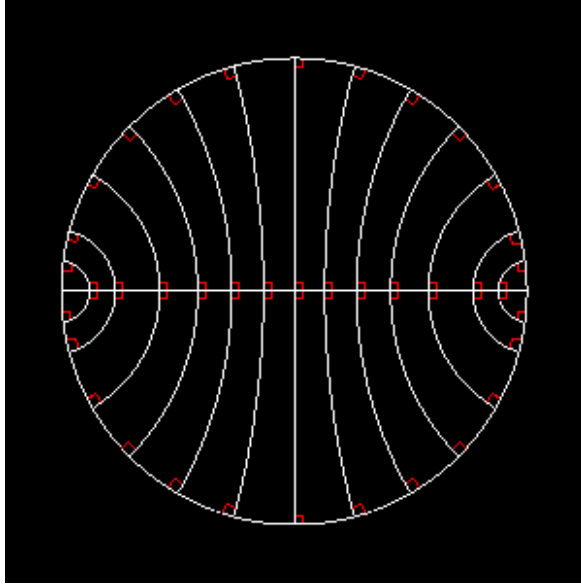

The loss of inertia is lost AS space, not IN space. This extremely important principle must be grasped otherwise nothing can be fully comprehended. If one were to analogize this as the air within ones lungs as inherent bodily inertia 'keeping one going' (alive) being lost to a balloon in its inflation and creating space that would be a crude but accurate analogy; if this assists in visual comprehension then all the better. Looking into the depths of space one is looking at the discharge of mind bending enormous amounts of inertia in dissipation. Magnetic reciprocation ultimately reasimilates along the centripetal or dielectric inertial plane however this hyperboloid in dissipation creates space, the footprint or trail of inertia in loss, which is definitionally movement. Space is movement, which is the loss of inertia which is space. What is 'left behind' of divergent magnetism is movement, is space, but this not imply implicitly or explicitly that space is anything or has properties or is an entity with attributes to a principle we deem as 'space'. Ultimately this space is unwound in convergent bodies via gravity, or dielectric voidance, or centripetal charges.

Below: The Poincaré disc maps the point at infinity of a hyperbolic space to a circle where hyperbolic lines are represented as arcs of circles intersecting the Poincaré disc at 90 degrees. As we move away from the origin of a hyperbolic space, the space itself expands due to negative curvature (convergent centripetal magnetism) so as we reach the perimeter of the Poincaré disc, the scale of the space changes dramatically, subdividing into an infinite number of pieces. Lines passing through the center of the Poincaré disc are on circles of infinite radius and this look like straight lines. Images below bottom are the hyperbolic extrapolation of divergent and convergent concentric stereographic projections of magnetic radiation as per the necessitated reciprocation of magnetism in the loss of dielectric inertia. In more complex and accurate detail, these draw out a hypotrochoid pattern.

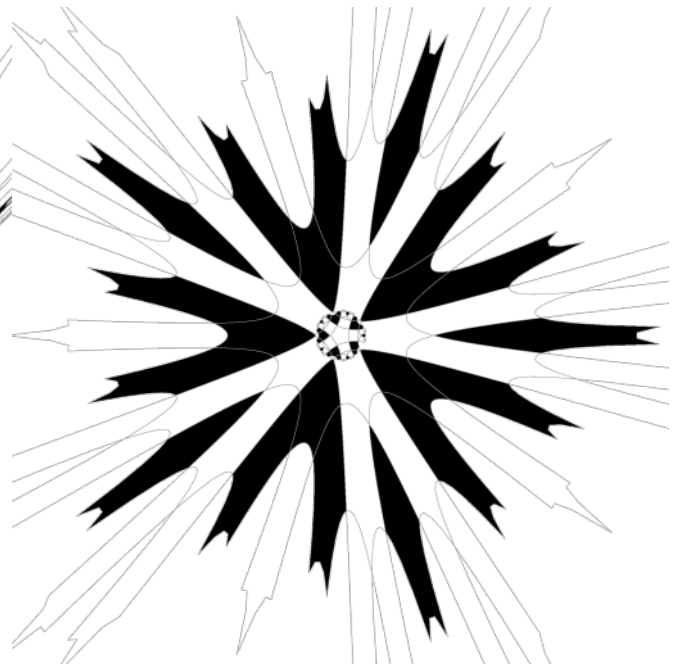
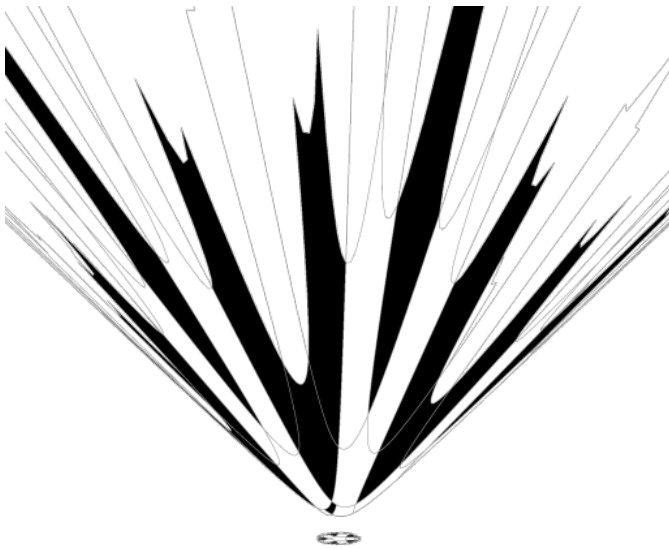
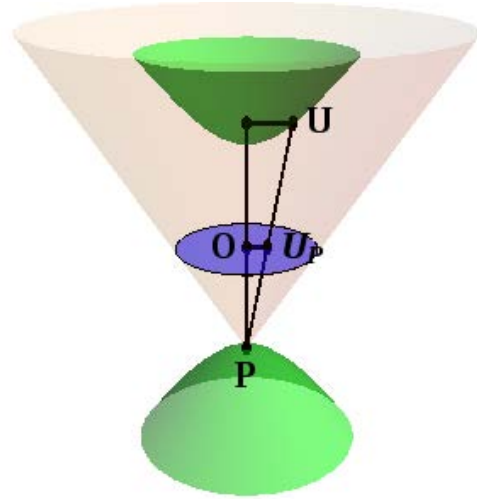
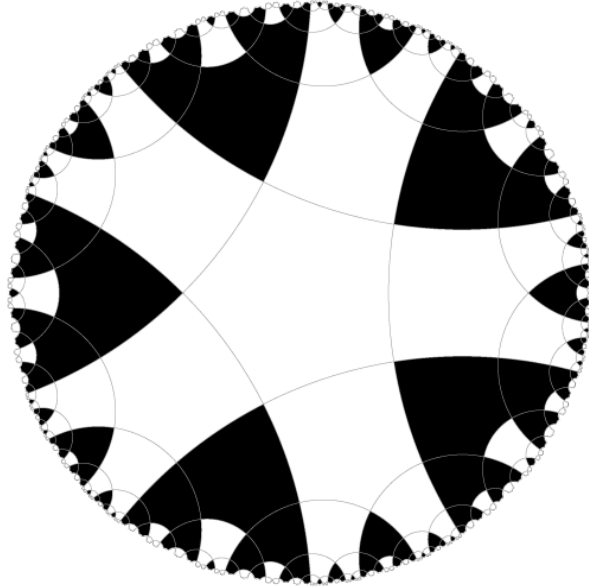

The presumed increasing movement or acceleration of these bodies or charges is the unwinding of the motion which is space, just as a rock thrown into the air will halt, and the space between it at the Earth is voided by unwinding the space between them both as expressed in increasing movement (voiding space) until voidance is met. Obviously the dielectric pressure voidance must exceed the movement as measured in spherical volume separating the two bodies, otherwise cancelation will not occur. Terminal velocity, either in the air of the earth or in the reaches of space has terminal limits of induction, either resultant to air friction or the limits of spatial voidance expressed by C^2 . However this velocity is not applicable to longitudinal and other field modalities which have no spatial vectorization and are a not hostage to this rate of induction.

Below: The hyperboloid in increasing coherency and capacitance. This is the formation of the magneto-dielectric system of the magnet, however its divergence is governed by the geometry of the hyperbolic disk.

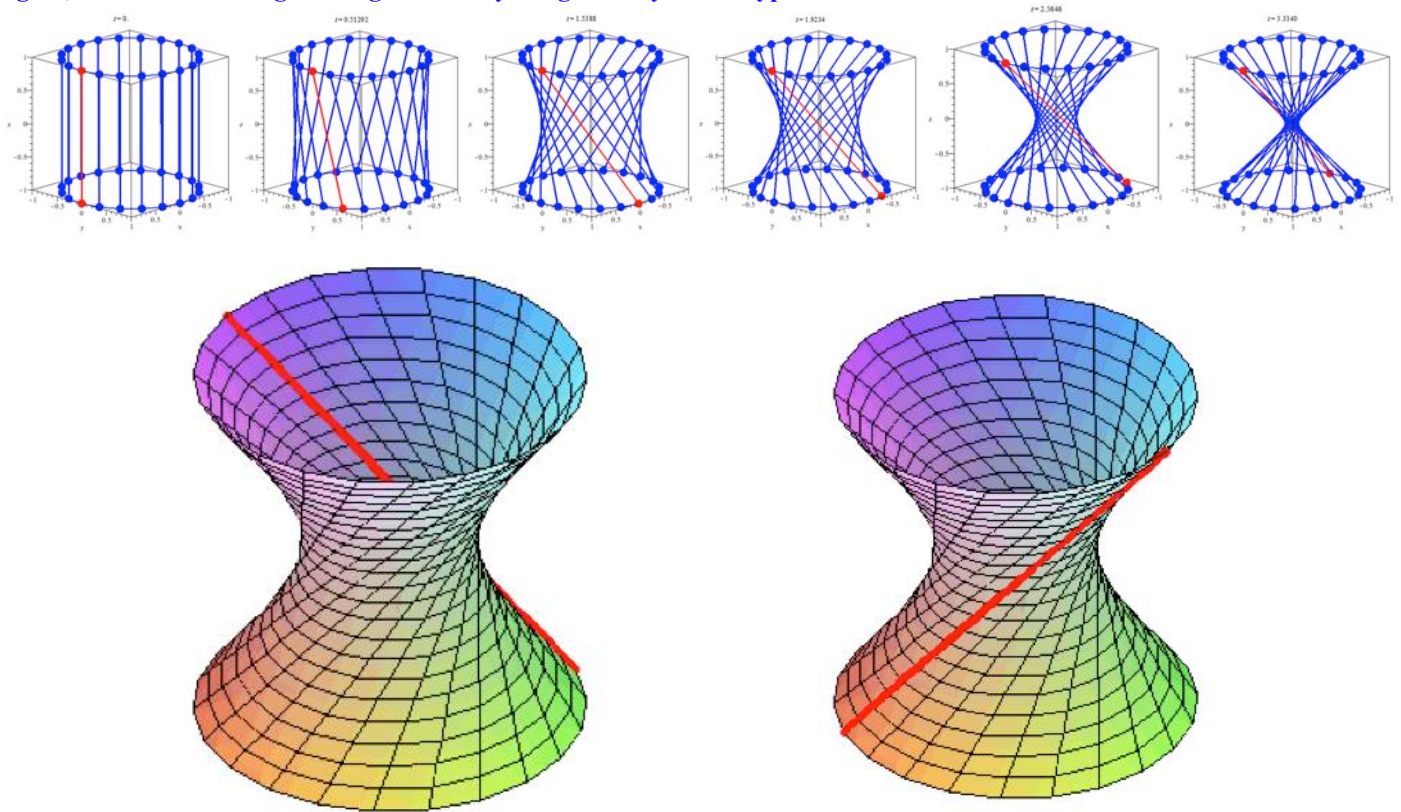

A moving body by means of charge, gravity, or dielectric voidance (between 'magnets') is empirically seen to be increasing movement in voidance but this movement is in fact actually a voidance of movement in eliminating the space between these objects and thereby increasing inertia. This is the cogravitational field of Oliver Heaviside which is an accurate model of gravitation and opposed to the incorrect model of gravitation as posited by the fool Einstein. All movement is a discharge, all relative movement in voidance is not movement at all but spatial (=movement, magnitude) voidance between two or more inertial charges or masses.

A cogravitational field is any spherical domain, or region of space between two or more bodies where these masses undergo the cogravitational field by which space itself, **definitionally movement**, is either voided or increased (due to divergent decelerating movement). When Maxwell defined the electromagnetic field he utilized similar words, [3, Vol. 1, paragraph 44, p. 47]: "*The Electric Field is the portion of space in the neighborhood of electrified bodies, considered with reference to electric phenomena.*" All phenomena are definitionally discharges and movement, the loss of inertia and the creation of space within which phenomena must be observed and noted. True Ether inertia is the antithesis of phenomena. It is incalculable.

At first one might ask: How can a region of space propagate in space? This makes no conventional sense. If the field is not a region of space, what definition should we utilize? Space itself is connected to one or more magnetic divergent fields. Space has no existence whatsoever of its own accord, and is only a posterior attribute of magnetic divergences; there are no "fields in space", only divergent space in creation as posterior attributes of polarized and or transverse fields. This space, an attribute of divergent fields, has itself an attributional (but no attributes!) limit of induction or propagation as measured in C squared however this only applies to transverse and spatial phenomena, not longitudinal phenomena nor to dielectric inertial fields which exist underneath space as defined by their existence in counterspace.

Below: The hyperboloid, proving that the dielectric inertial plane = 0, which is = 1, or infinite inertia. The fundamental comprehension of this principle is absolutely necessary to understand the conjugate nature of the magneto-dielectric field mechanics of both the universe and the operation of how a “magnet” works, both in whole and in part.

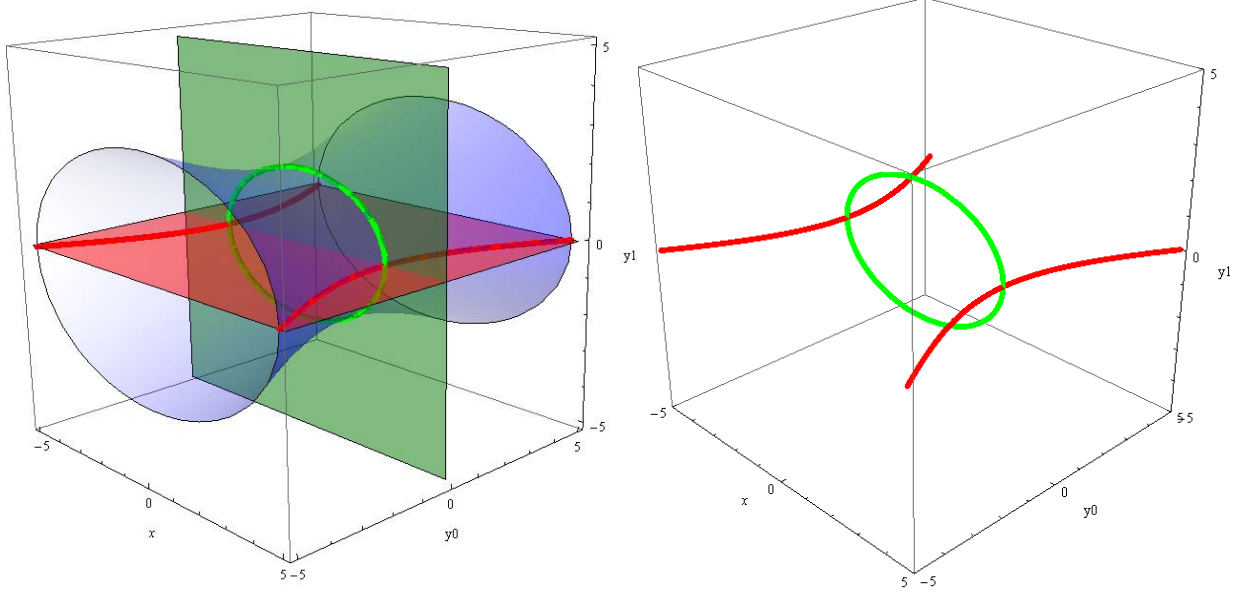

$$\frac{x^2}{a^2} - \frac{(y_0 + iy_1)^2}{b^2} = \left(\frac{x^2}{a^2} - \frac{y_0^2}{b^2} + \frac{y_1^2}{b^2} \right) - i \left(\frac{2y_0y_1}{b^2} \right) = 1$$

The only way this is possible is if $y_0 = 0$ or $y_1 = 0$; otherwise, the imaginary part of the left side is non-zero, while the imaginary part of the right side is zero.

Pathetically and altogether expected observational flaws conclude that, for instance, two “magnets” in increasing movement between each other in voidance (‘attraction’) are rationally ‘increasing movement’, but the case is that the spherical magnetic attributes of divergences (i.e. space itself) between them is being voided. What is being seen in this presumed increasing movement is in fact a reversal, an unwinding, an erasure of the spatial divergences between these two (or more) objects. Literally the space, which is definitionally movement, is being unwound in voidance. As such the observational movement(s) does not belong to either object rather the cogravitational (magnetic spatial divergence) field attribute being eliminated. Increasing movement over time (co-attribute of space) can only be the product of increasing inertia between two or more objects undergoing voidance. But however this increasing movement is not attributional to either object rather the reversal of the spatial divergence defined by and as movement in decreasing spherical volumes between the two objects in voidance (undergoing). Newton’s first law is utterly defunct and makes no allowances for fields as autonomous from forces nor does it take into account the fact that space itself is definitionally movement, is divergence.

Potential cannot be measured, potential is the antithesis of phenomena, is inertia, is counterspace, is the Ether. Humans cannot measure or define anything devoid of volume or phenomenal characteristics. Potential in actualization is divergence, is phenomena, is governed by magnetism and therefore space in creation and therefore also movement and time. In positing the one, you get the rest necessarily so, that being space, movement, magnitude, phenomena and time.

Below: The hyperbolic disk, as per the Poincare' disk model. However the ancient Greeks knew of this long before Poincare' and expressed same by means of another analogy.

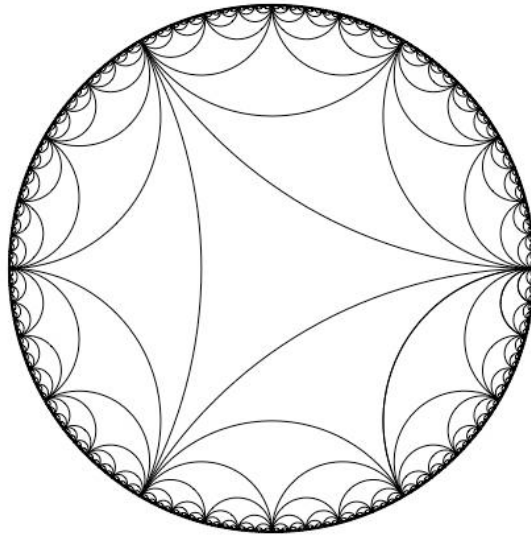

Rest can only be said of the pure dielectric or Ether inertia, never of any mass or body, simplex or compounded. Space is literally a rubber band, a seemingly (only so) static pressure awaiting dielectric (gravitational, inertial dielectric in a 'magnet', or charge, as crudely called attraction) voidance to loose its inflation and impel objects and fields in increasing movement in rapid spatial deflation of contracting spheres of movement being unwound (i.e. space) towards increasing potential inertia and decreasing spatial discharges towards higher states of inertia potential. The presumed "cogravitational field" of O. Heaviside is in fact the deflation of space itself between two or more bodies within which increasing movement is observed, but this movement is a property of space itself (not the objects) unwinding between objects or dielectric fields undergoing mutual counterspatial dielectric voidance (as meant spatial voidance, not literally the voidance of the dielectric, rather denoting voidance by means of dielectric acceleration, a counterspatial 'movement'). The reversal of movement (space) is yet another (so-called merely conventionally) movement (counterspatial voidance), increasing, but in voidance, in elimination, deflation, and erasure, not expansion; not unlike a rubber band, or any polarized tension which must be voided. Terminal speeds of voidance are dependent upon the intervening medium, friction, and limits of the medium of induction, in the case of space, this is C squared, however this is J.C. Maxwell's discovery, not the idiot Einstein's.

Counterspace is the opposite of any and all movement definitionally, only phenomena (as both meant and implicative of space) have movement, are divergent. A "movement towards counterspace" is not parcel to counterspatial inertia rather the necessitated unwinding of space, or as implied the inversion or erasure of the sphere or spheres of spatial divergence within which movement must and is re-expressed in reversal. The opposite of movement is not rest, as per Newton's wrong premise, rather inertia. Likewise it can be stated the opposite of space is inertia, since movement and space are interchangeable qualities of divergent byproducts of polarized fields undergoing reciprocation.

Below: The hyperbolic disk is and is necessitated to diverge and converge along the 137.5077 and 85 degrees (=1). This is proven, this is necessitated, and the model of how the 'magnet' and magnetism works has been fully established. Discovery 7-12-2014 Ken L. Wheeler.

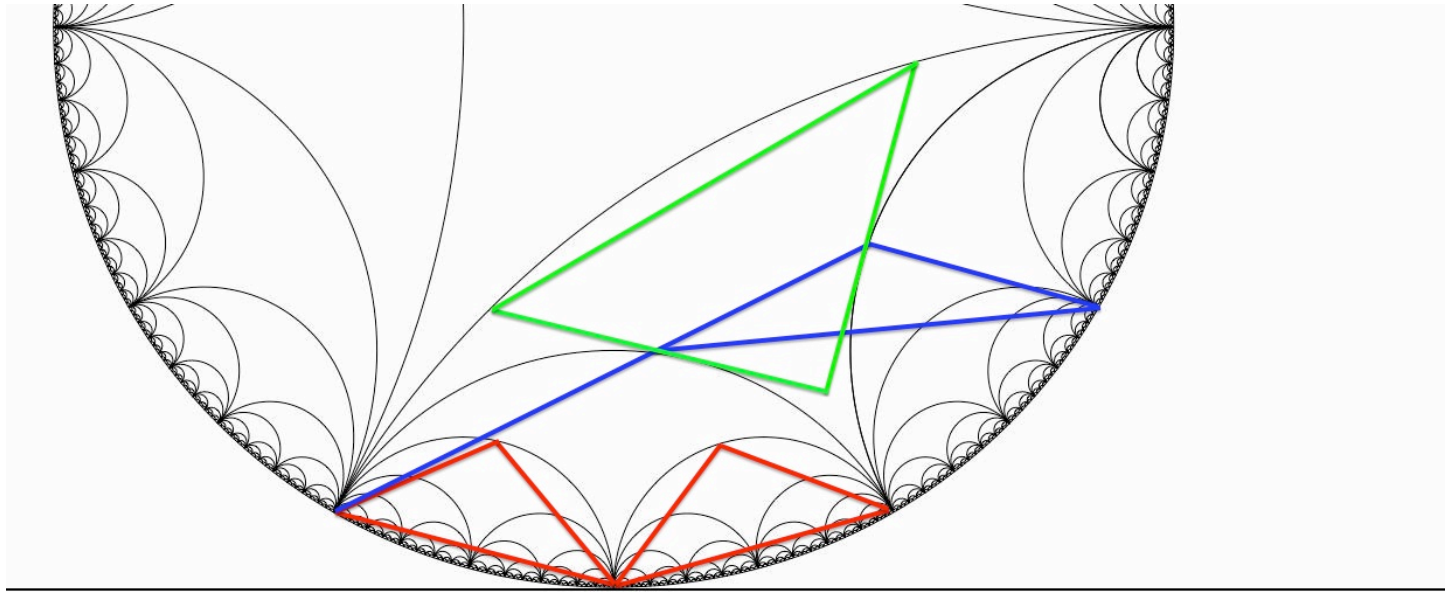

Counterintuitively to the pedestrian mind saying inertia is the opposite of movement seems alien, however this is a mental defect which must be overcome by comprehension. To say that inertia is both “it resists being stopped and it resists movement” is likewise an incorrect definition of field inertia and is a bastardized application attached to phenomenal objects, and cannot be applied to fields as pertains both motion and inertia which are wholly opposite each other. We have stuck in our brains the concept of a moving object “having inertia”. We may say this is correct in the framework of phenomenal contrivances in explanation but the exact opposite is the case as pertains fields. The two cannot, must not, shall not be confused if comprehension is to be grasped.

The four necessary principles of electrical engineering are 1. Time 2. Space 3. Dielectricity and 4. Magnetism. This can be further reduced into: 1. Movement of / between 2 and 3 (in which case time is a posterior attribute of measuring magnitudes in movement) 3. Dielectricity 3. Magnetism. Further still again it can be reduced into one principle. 1. Dielectric inertia torque generated using a magnetic field varied with respect to its pressure zones against the dielectric reflector. Space is merely a posterior expression of polarization, and time is a posterior expression of space in measurement. Space is definitionally movement and the byproduct of magnetic polarized field divergences. Space has no quantity, motion is a quality and stereographic unreal projection of the loss of inertia, space is only the attributional quality of movement which defines it. Rather than declare we or it is ‘moving in space’, it is correct to state that we or it is “in space which is movement”. The cogravitational field is the shrinking or increasing sphere of movement, i.e. space, between two or more (typically) bodies. Inertia must be given true definition as pertains to fields. All decreasing movement is the discharge of inertia, all increasing movement is the voidance of space and the increasing of inertia which is counterspatial. A moving body is a false representation of true inertia as found in a dielectric field, as expressed by either gravity, convergent centripetal voidance, or increasing charges.

Below: The divergent hyperboloid drawing out the hypotrochoid divergence.

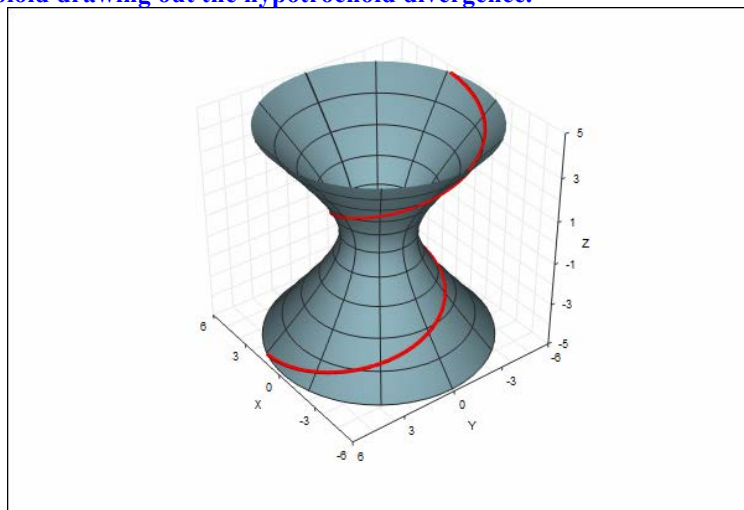

Newton's law was composed in ignorance of the nature of empirical bodies which are never at rest in nature. All space is definitionally movement, relative movement between two bodies is pressure mediation and either the dissipation of inertia or the increasing of same. Likewise increasing movement between two or more bodies denotes the voidance of space and the magnetic field which created same in its divergent wake as necessitated attributional volume to the hyperbolic magnetic divergence. When all motion is eliminated, empirical bodies are likewise eliminated. Newton's idiotic premise might as equally state that water is at rest in a tub when the drain is fully emptied of water. All motion is curvilinear pressure mediation and either decreasing in movement, the dissipation of inertia, or increasing in motion, the voidance of space between two or more objects. The dissipation of chemical inertia in gasoline has transference into motion, again all increasing motion over time (in the case of a tank of gas, it is ultimately decreasing motion potential as the tank is emptied of course) is the loss of inertia, is translational into radiation and or motion.

Below: Space is definitionally movement, relativity is a pure farce. The property of movement relational to space is only 'granted' to same by way of divergent magnetism, and does not admit to space as an entity or principle in itself. This premise is the reason the idiot Einstein thought space can or could be 'warped', due to enormous dielectric voidance of motion, or space, however this premise is insane and flawed, only his brain and intellectual prowess was warped in making such a pedestrian declaration. Inertia eliminates space, magnetism, divergence, and of course motion. From the 'view' of the hyperbolic disk, magnetism returns as it leaves in a dimensionless line; from the 'view' or premise of the empirical universe (definitionally IN SPACE), magnetism reciprocates in hyperbolic divergences and convergences. Space is wholly an unreal stereographic projection of inertia in discharge. Even the very term 'discharge' is not entirely correct (explained elsewhere).

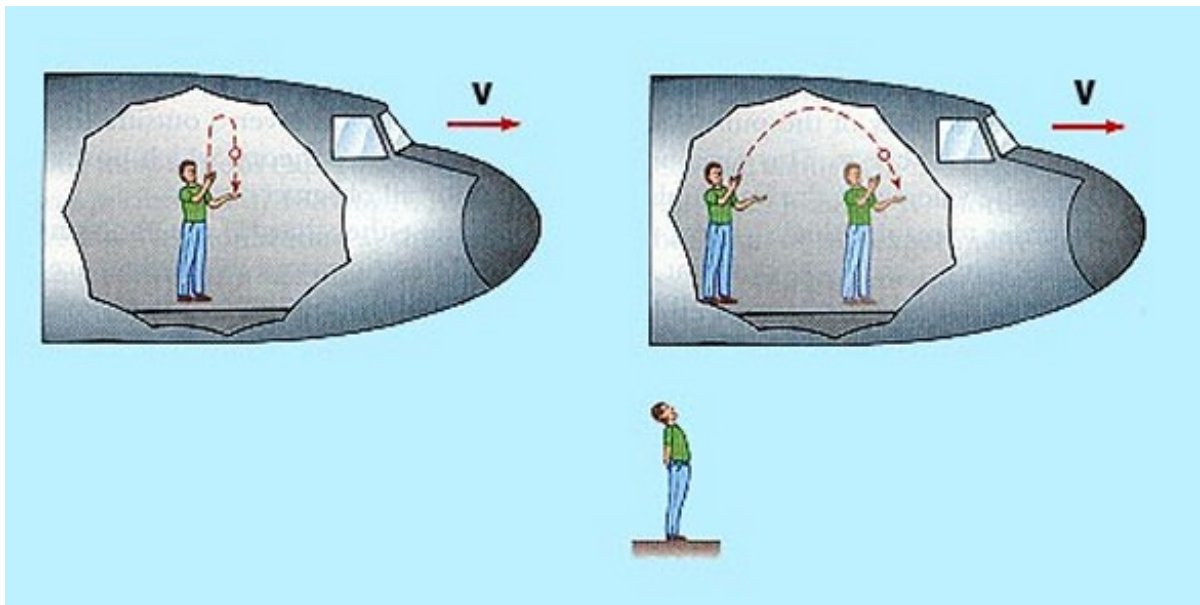

The hyperboloid of magnetism and its necessitated motion is the loss of inertia definitionally. The "dielectric field in discharge" necessitates both motion and the creation of space. There is not one billionth of one microgram of matter in the universe that has any spatial volume save for magnetism. All space is supported by and created by the loss of dielectric inertia, as both meant and implied magnetism. Magnetism is a hyperbolic torque (tension) by which the Ether modality of inertia in discharge mediates its own discharge in creating the hyperboloid of magnetic centrifugal divergence against the inertial 'line' of the dielectric inertial plane of the so-called "magnet" (the coherent dielectric object) and mediates this pressure by polarized reciprocation and transverse reintegration once inertia has been regained. As has been said many times, no field can terminate in space since space is not a terminal of, or for fields. Inertia is dimensionless and stable however atomic inertia is constantly being 'tapped' and drained and necessitates inter-atomic magnetism; all movement is the breaking of inertia and necessitates magnetic divergence and polarized reciprocation. There is no prima causa, the highest movement inherent to Ether inertia is $1/\Phi^{-3}$, and likewise the sufficient co-principle (aoristos dyad), or attribute of The Principle, for all empirical manifestations.

Below: Generation of the magnetic hyperboloid of infinite dielectric inertia in discharge as per the Poincare' disk using AutoCAD. Notice the necessitated hypotrochoid on the far right. This is what is seen in the ferrocell, this is how magnetism necessarily reciprocates both divergently and convergently.

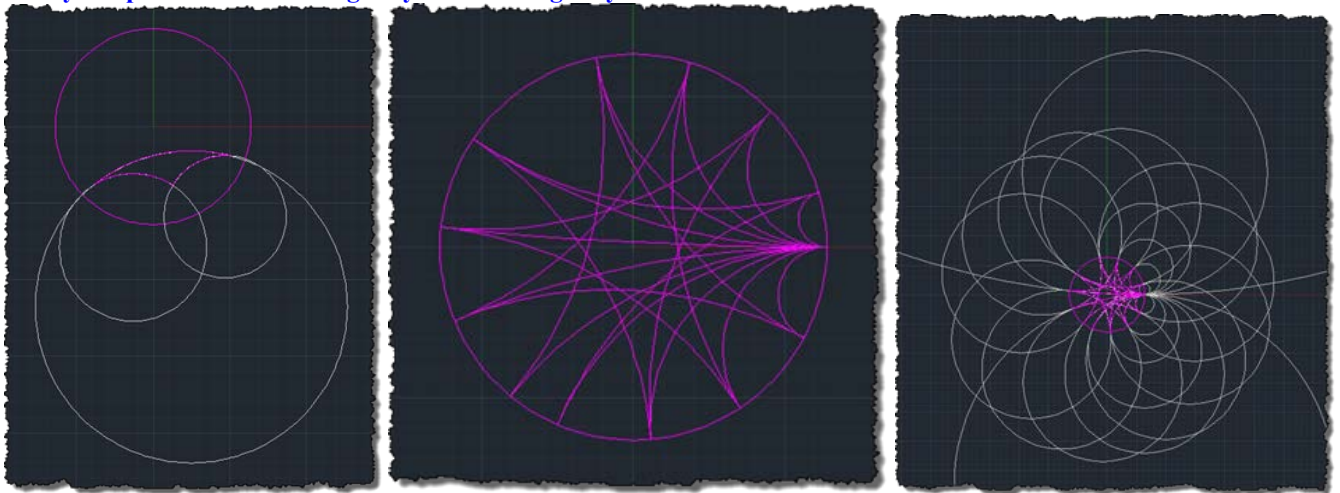

The concept of “inertial mass” as posited by Einstein, Tolman and other mental midgets conflates the false premise that inertia is or is translational to mass, to magnitude; it is not. Mass is only as pertains to discharges, magnetism, phenomena and movement / space, not to inertia relevant to fields. The expressed energy of a system or mass is not translational or directly related to inertia. Energy relational to dimensional or three-dimensional coordinates are not directly applicable by any means with inertia which is counterspatial, and not in space, nor phenomenal. Einstein's tensors, pseudo-tensors, and reification of space as ‘something’ that ‘does things’ is a pure insanity and the child of a mental midget. The property of movement relational to space is only ‘granted’ to same by way of divergent magnetism, and does not admit to space as an entity or principle in itself.

Below: Human ignorance is literally in the ‘dark’. All the nonsense so-deemed by the cult of quantum as dark matter (sic) and ‘dark energy’ is **nothing more complex or convoluted than unmanifest dielectric inertia**, the most fundamental, the most rudimentary Ether modality in the universe. On the image at right, at top we have magnetism >1 , in the middle we have dielectric inertia <1 , and at bottom we have the Ether itself $= 1 / (\Phi^{\wedge}3)$. This, my discovery of 13 year ago, is the equation behind all Ether modalities and the universe itself, simplex and divine, $1/\Phi^{\wedge}3$.

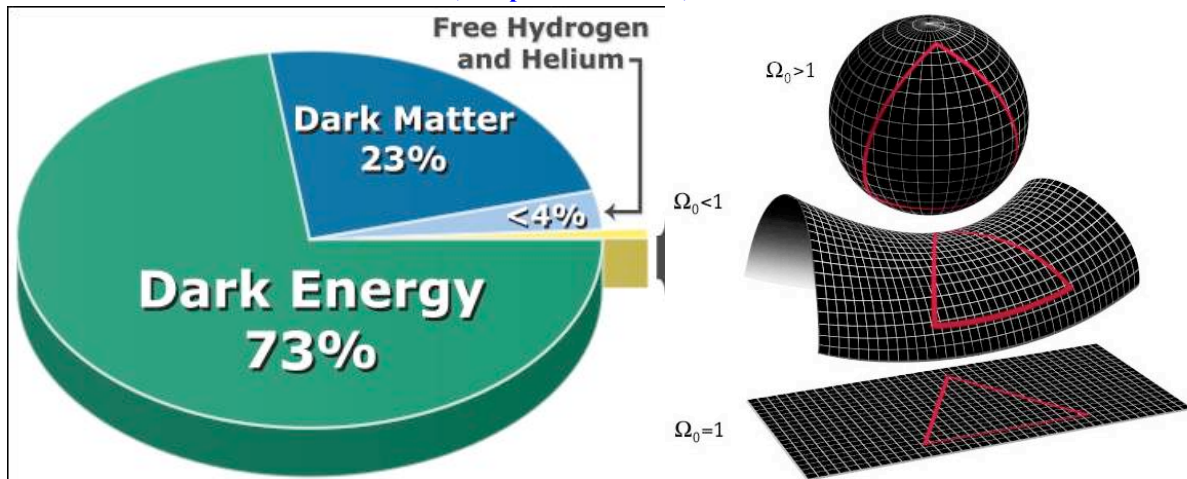

For example the Schwarzschild solution of the presumed inertia of a mass can assume any value depending upon the spatial coordinates. Inertia is pre-extant to any and all phenomena and inertia likewise cannot be quantified based upon bodies or masses. That presumed fallacious 99.999999999% of ‘nothing’ or ‘empty space’ at the inter-atomic of every atom accounts for 100% of the energy released at the explosion of a nuclear device, NOT the conversion of any matter into energy. If this does not define inertia for you as being wholly separate from phenomena, then nothing will. As such, from the idiocy of Einstein and others 100% of “nothing” is in fact responsible for 100% of the power and energy released in a nuclear blast. As per wisdom, the world still exists deep in the dark. Here we can see that the general theory of insanity as posited by Einstein and parroted by others as per “inertial mass” (a pure contradiction) depends upon the spatial dimensional coordinates of that mass and therefore has no ultimate meaning whatsoever. Likewise therefore the assertion of the equivalency of mass and inertia is purely insane and wholly untrue. Inertia has neither magnitude, space, nor direction, only divergent magnetic fields do. This magnetism is movement, is phenomena, is discharge. What is potential, inertia, goes unseen and unknown and is without measure in the absolute sense and as the Absolute. The ‘unspooling’ of

counterspatial inertia in discharge as magnetism, just like a spring unwinding creates space, this space is movement, is motion. All that presumed 'empty space' is a motional after-shock of inertia in discharge, waiting to be voided. All motion, all space must terminate and end, even if it persists for an incalculable seeming eternity, it will terminate in reversal, the movement (spatial reversal) into counterspace. What is potential is not actual. What is actual or actualized is the unspooling of potential and the 'winding' up of movement. Motion and space are both (one and the same) the mirage of inertia in phenomenal actualization.

Below: Crude representation of the magneto-dielectric hyperboloid. Using the ferrocell and others methods, one can see the shrinking spatial sphere of dielectric voidance where inertia is assimilated between two "magnets" or by means of any dielectric coherency. One cannot understand the field incommensurability of the "magnet" without grasping the inertia-spatial magneto-dielectric hyperboloid at a fundamental level within your mind. Central inertia cannot be measured by means of mass calculations; this very premise is the basis for every flaw of relativity, quantum, and mathematical non-Euclidean pseudo-physics.

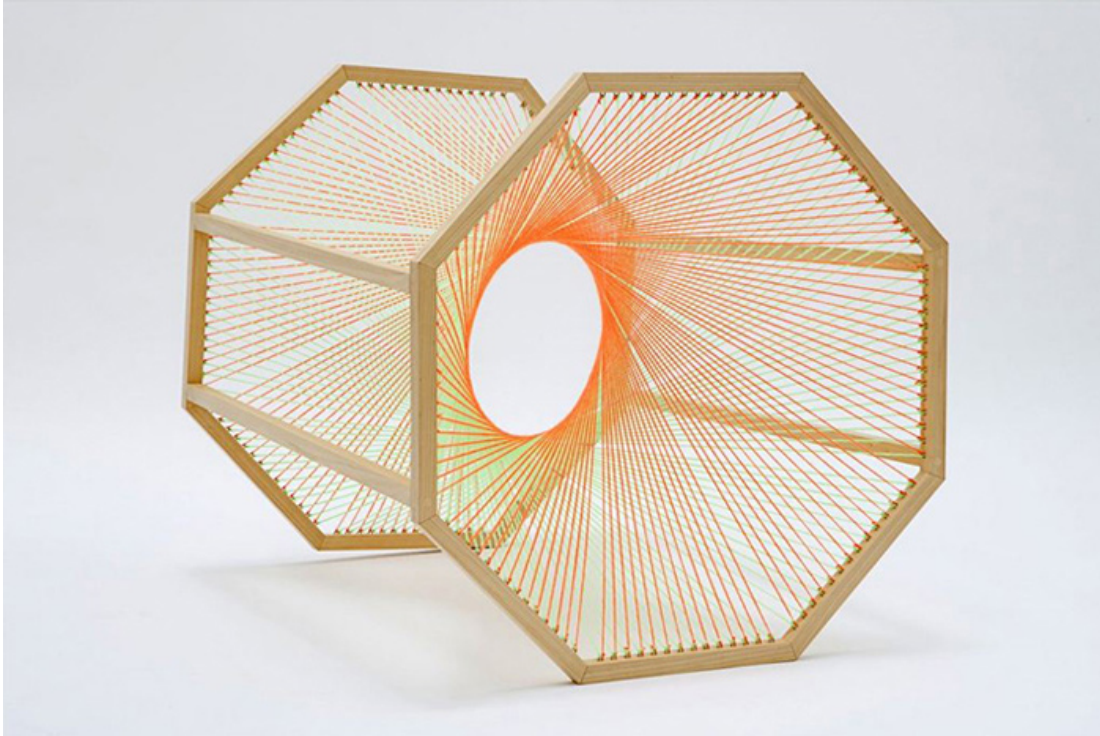

"For it must be confessed that the exhaustion of potential energy from a universal medium is a very unintelligible and mysterious matter. When matter is infinitely widely separated, and the forces are least, the potential energy is at its greatest, and when the potential energy is most exhausted, the forces are most energetic!" – Oliver Heaviside [Part I, The Electrician, 31, 281-282 (1893)]

By "widely separated" Heaviside is referring to space, by which we can state that the greater the divergence between matter the greater the movement (=space) that exists and must voided to terminate the (multiple) objects of matter (dielectric condensates in motion which likewise produce, obviously, magnetism). This so-called 'potential energy' is not energy at all but the motion that is space which is voided in increasing motion towards increasing inertia and dielectric convergence ('voidance'). When speaking about the "potential energy most exhausted" Heaviside is referring to a singular mass which has the highest collective gravitational "force". But this is field inertia, not force. Accelerating or moving bodies in voidance are voiding space and increasing collective inertia. Heaviside is incorrectly using the term 'energy' to refer to movement, i.e. space, and likewise wrongly using the term 'force' as applied to dielectric inertia as found in the condensate of matter/mass.

Below: The forming hyperboloid of the magneto-dielectric system of the magnet as governed by the hyperbolic disk, the loss of inertia and necessitated spatial vectorization as the Ether modality called magnetism. Polarization is the creation of space, not “into space”; rather the creation of space as resultant byproduct of the divergence of magnetism and its reciprocation.

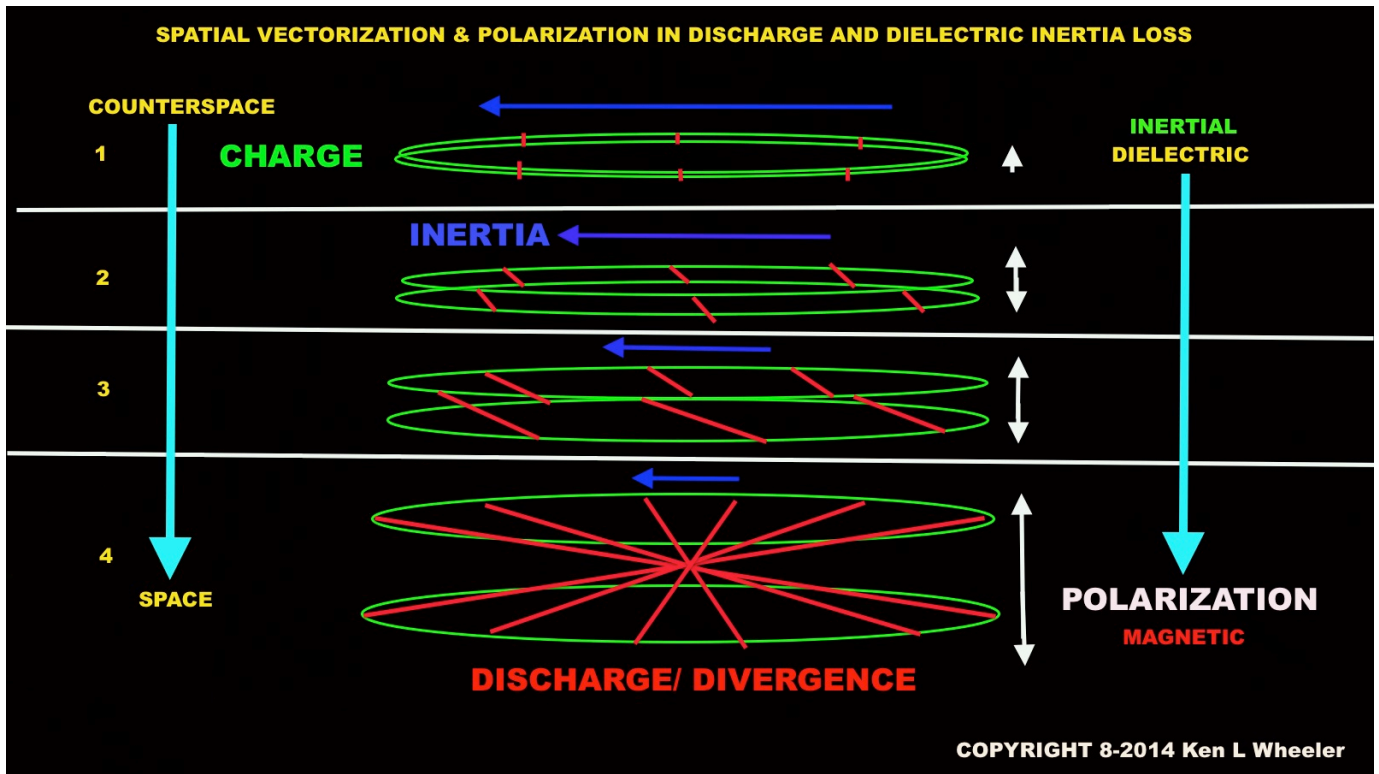

In short, Heaviside is speaking about, analogously, a 1 kilogram mass spread across the cosmos having a high “energy” (space, motion) potential towards mutual convergent movement (voiding space) and the same 1 kilogram mass together having voided space (the lowest spatial situation or “energy” in his incorrect wording), but the highest collective counterspatial gravitational inertia which, of course, voids space. This premise is the reason the idiot Einstein thought space can or could be ‘warped’, due to enormous dielectric voidance of motion, or space, however this premise is insane and flawed, only his brain and intellectual prowess was warped in making such a pedestrian declaration. Inertia eliminates space, magnetism, divergence, and of course motion.

Space is not warped or otherwise, rather is the aftershock of divergence as measured in motion and likewise by time which is voided in counterspatial fields, centripetal convergences, gravity, dielectric convergences. Nature does not abhor a vacuum, she abhors the motion that is relational and attributable to space itself. However, of course, this motion, this space, this divergence, this magnetism is as necessitated as illumination is to light itself. Absolute inertia or inertia before discharge cannot be measured, and likewise the energy of a mass cannot be made an equivalency with inertia in quantity.

Below: The Poincare’ disk in stereographic projection is literally the vectorization, the polarization, the divergence and the ‘emergence’ of the Ether modality of magnetism. This is the nature of magnetic divergence, what it is, why it is, how it is, and is absolutely without reproach, and irrefutable. It cannot exist any other way or by any other means. You are witness to the first complete and total (and unfolding in this work in whole) explanation of what magnetism is and how the magnet works, and its field mechanics.

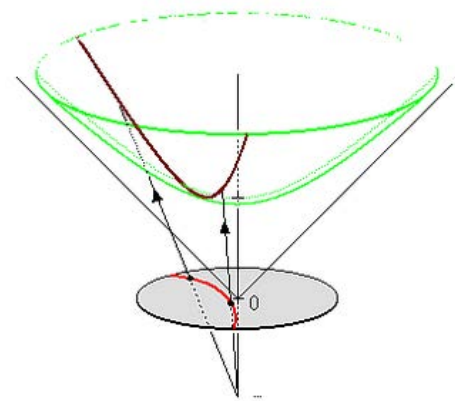
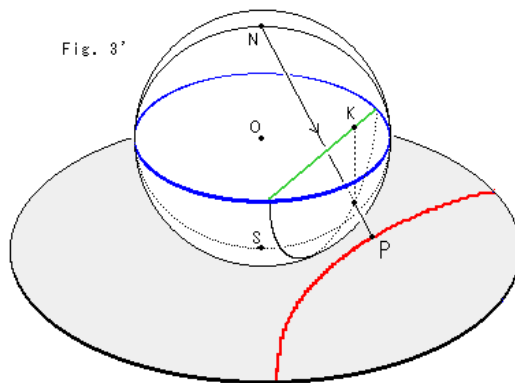
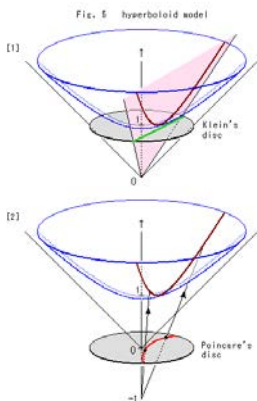

Below: The Poincaré Disk model of hyperbolic geometry is obtained from the hyperboloid by stereographic projection. Stereographic projection of an ordinary sphere maps the sphere to the XY-plane by projecting from the South Pole; points in the Northern Hemisphere ($z > 0$) map to the interior of a disk, points in the Southern Hemisphere ($z < 0$) map to its exterior, and the Equator ($z = 0$) maps to the circle bounding the disk. The idea of stereographic projection is the same for the Minkowskian hyperboloid. But what are the Poles? They are dielectricity in discharge, i.e. magnetism. They are the two points where the t-axis intersects the hyperboloid, but now we need both branches. So the South Pole is the point. $P=(0,0,-\rho)$

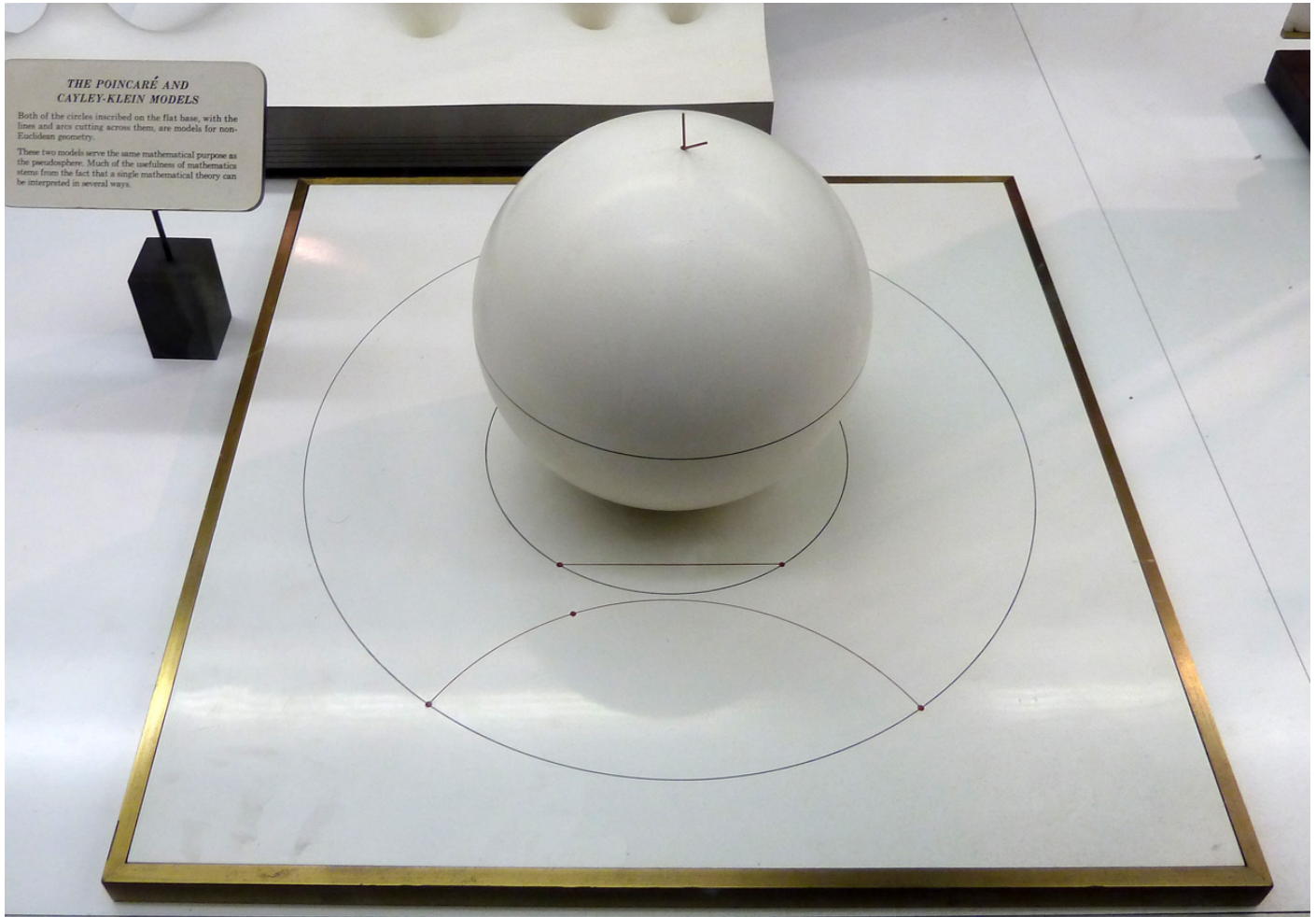

All discharges are definitionally spatial. Magnetism's divergence into the creation of space, inversely and incorrectly deemed by many as 'into space' rather than, accurately, creating space; the natural counterspatial and radial nature of dielectricity is necessitatively divergent in discharge in an expanding circulatory fashion. But this is still lacking in an explanation and is merely an elaborate description, which is insufficient.

Spatial vectorization of loss of inertia in discharge (as per the Poincare' disk model which dielectricity MUST follow necessitatively) is not a termination, only a (posterior creation of space as both meant, implied, and connotated by the term polarization) vector of reintegration to 're-initialize' the loss of inertia to maintain a stasis of the Ether-modality of dielectricity denotated as magnetism in its polarized state of 'resetting' its own pressure mediating inertia by spatial vectorization and radial assimilation to its original radial inertia.

Below: Various visual models of hyperboloid expression demonstrating divergent torque in loss of inertia necessitates both gyromagnetic precession and inverse vortex spin magnetic divergence.

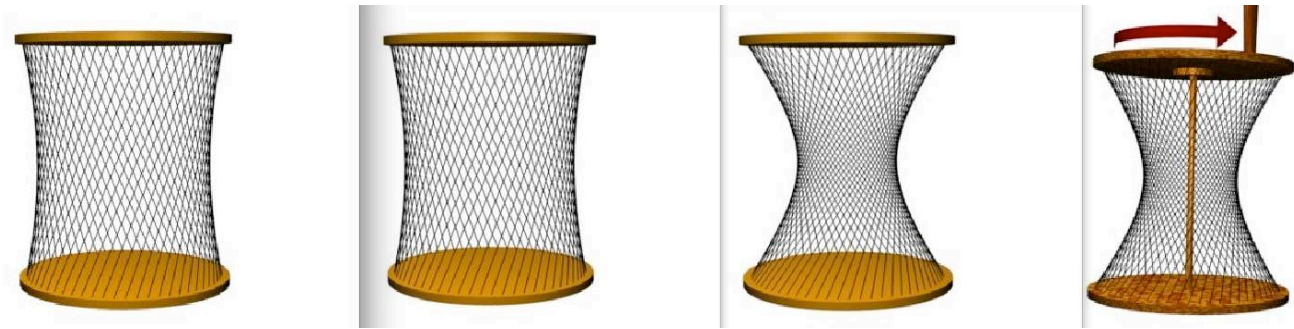

The loss of dielectric inertia in discharge necessitates the spatial vectorization into magnetic polarization, this of course is the Ether modality of magnetism.

The Poincaré disk model, also called the conformal disk model, is a model of n-dimensional hyperbolic geometry in which the points of the geometry are in an n-dimensional disk, or unit ball, and the straight lines of the hyperbolic geometry are segments of circles contained in the disk orthogonal to the boundary of the disk, or else diameters of the disk. What this means however is that you can ‘fit’ infinite dielectric inertial into a super-point of counterspace on a non-dimensional inertial plane, or ‘disk’. The Poincaré hyperbolic disk is a two-dimensional space having hyperbolic geometry defined as the disk with hyperbolic metric

$$ds^2 = \frac{dx^2 + dy^2}{(1 - x^2 - y^2)^2}$$

The hyperboloid model can be seen as the equation of $t^2 = x^2 + y^2 + 1$. It can be used to construct a Poincaré disk model as a perspective projection viewed from $(t=-1, x=0, y=0)$, projecting the upper half hyperboloid onto an (x, y) unit disk at $t=0$.

We must address the great question as to WHY magnetism must reciprocate centrifugally from one side to the centripetal point on the other pole. Firstly no field can terminate in space, because space is not a terminal for any field. Secondly Ether radiation, i.e. magnetism, unlike particle and dielectro-electromagnetism, cannot exist independent of its discharging source. Even ‘electromagnetism’ in the case of light cannot leave its dielectric Z-axis radial component.

Below: The convergent “pseudo-sphere”. To give an accurate visual model of how the (both convergent and divergent) convergent centripetal magnetism re-assimilates is drawn out by a hypotrochoid. As most have dropped a coin into a coin funnel, if you were to notice closely, it does not draw out a decreasing circle in radius but a hypotrochoid pattern, this is dielectric voidance, the erasure of space and increasing inertia. One the center is cross, there is infinite inertia and magnetism then ‘becomes’ dielectricity once again. Charge-discharge is all a null-fulcrum transference in simple, it cannot exist any other way. **The term ‘pseudo-sphere’ of course is complete nonsense**, literally all that is genuinely meant is the erasure of movement towards counterspace, the erasure of the sphere, or space, by means of a counterspatial movement, which is the voidance of movement, the assimilation of infinite inertia in counterspace. The notion that these geometries are “Pseudo-Euclidean” is pure absolute trash and nonsense, the full and ripe definition of counterspace found its seat and pinnacle with the ancient Greeks.

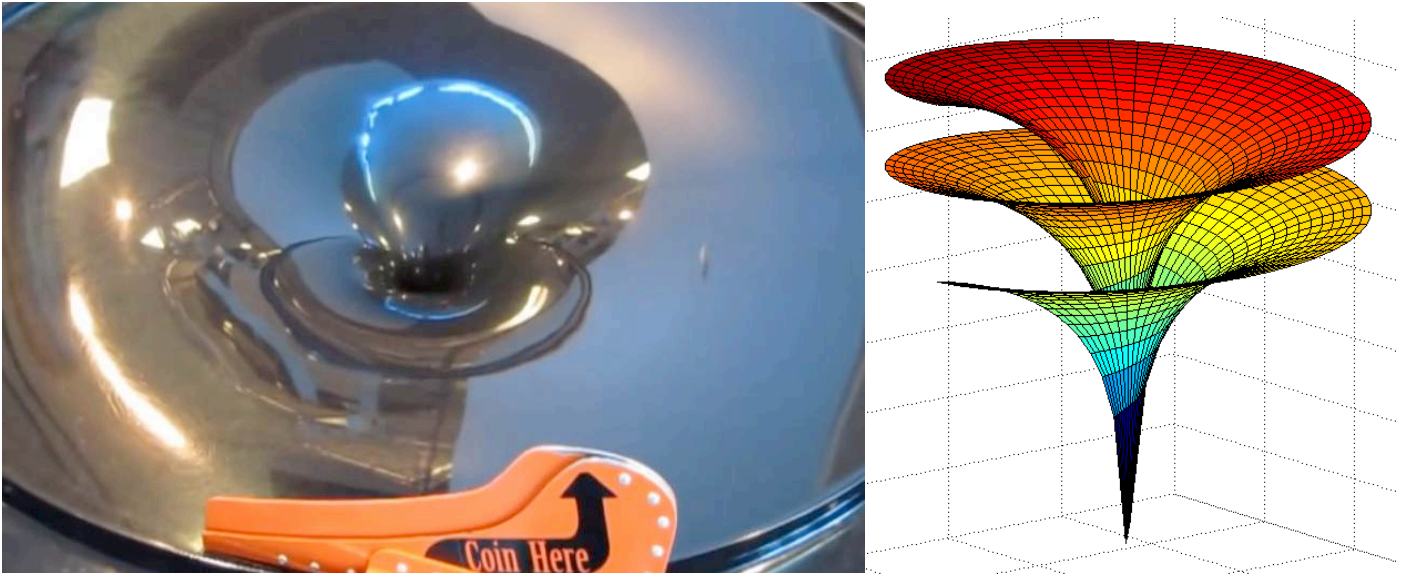

Below: The genuine magneto-dielectric “pseudo-sphere’ is not a spatial formation (humans can only see spatial phenomena!) as ‘seen’ below on the right, but inertial. **The decreasing ‘points’ are increasing discharge and increasing movement, increasing creation of space, likewise of course necessitatively decreasing inertia.** Moving towards the center is a movement to infinite inertia; by which, while it cannot be illustrated, the center section has no radius, rather is infinite.

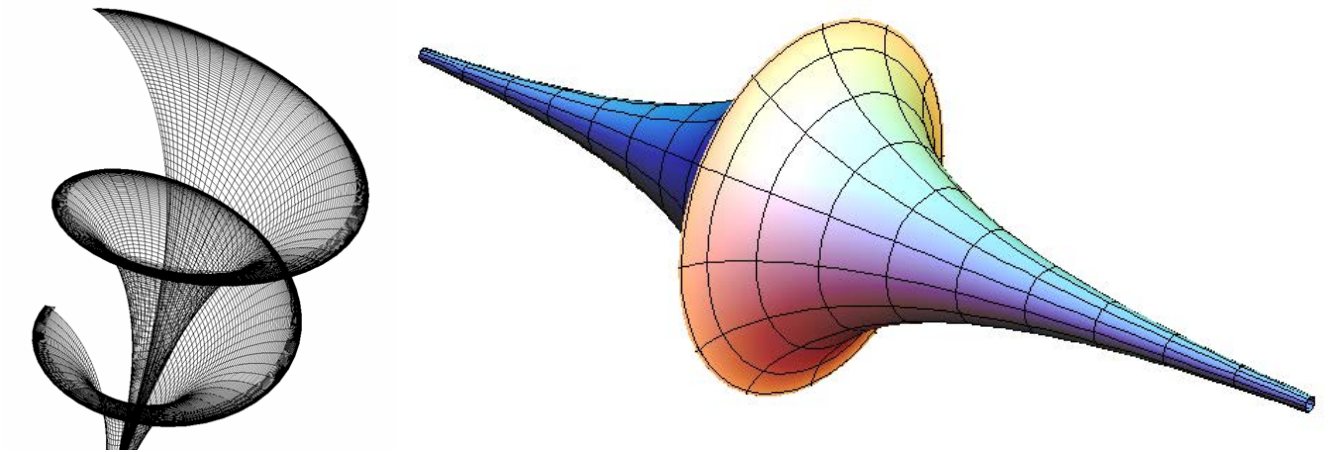

Magnetism is the necessitated spatial expression of inertial loss of dielectricity, which causes spatial reciprocation as the Ether modality of magnetism after which time it must terminate where dielectric voidance is lowest, centripetally on the other pole.

Even magnetic divergence must discharge its own divergence after passing the dielectric boundary of the physical magnet. The Ether fulcrum of divergence must polarize and definitionally reciprocate back to the point of divergence as re-initialized convergence.

Below: The many forms of hyperbolic stereographic projections of dielectricity in discharge which vary based upon gauss, power, and ultimately dielectric condensate zones of immense power where matter itself is created. The hyperboloid of 'two sheets' closes off divergence and creates a condensate of near-infinite inertia, the mass particle, when then necessarily creates its own space, the inter-atomic of the hydrogen atom.

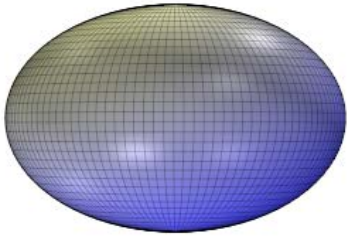

Ellipsoid

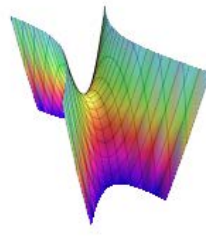

Hyperbolic paraboloid

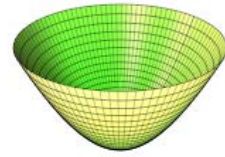

Elliptic paraboloid

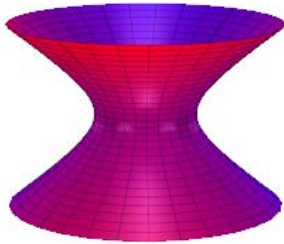

Hyperboloid of one sheet

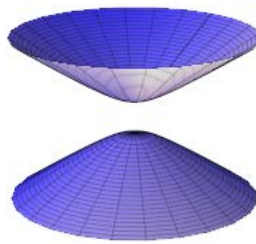

Hyperboloid of two sheets

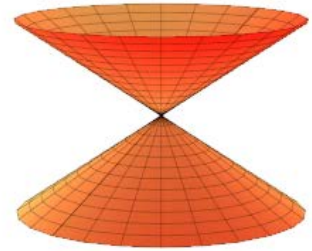

Cone

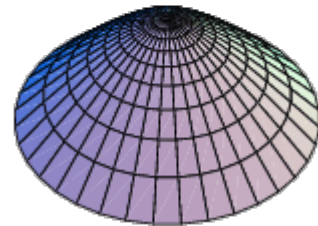
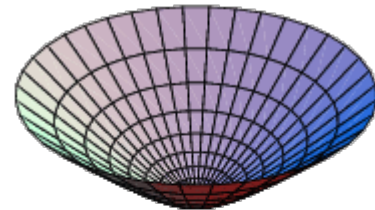
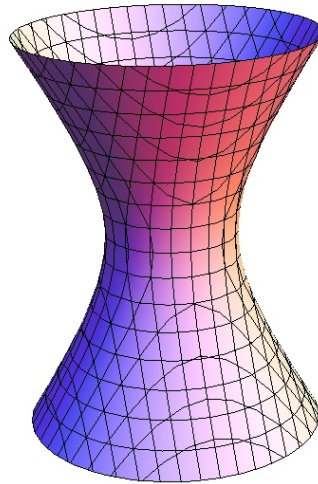
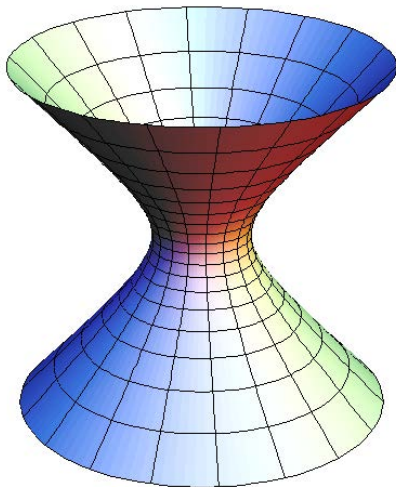

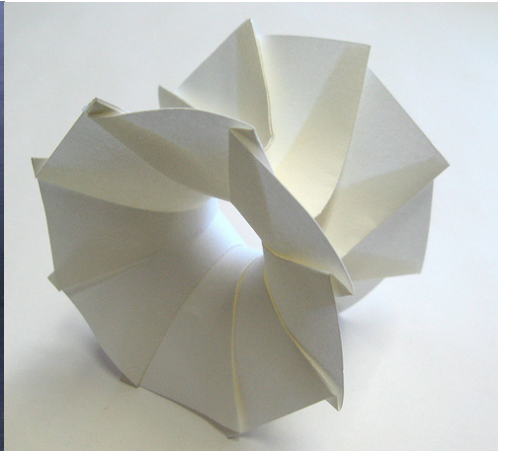
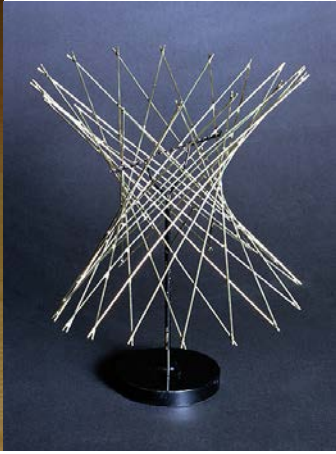

The Euclidean Ether expressed in four modalities and one principle of inertia

There is no such entity as warped space, only fields that are mediating pressures centripetally, centrifugally, transversely (dielectromagnetism), or radially as found in longitudinal dielectrics which are radial and without a transverse electrical constituent. As we already know full well, magnetism forms the complete hyperboloid of vortex reciprocation of dielectricity in discharging pressure mediation in the loss of its inertia in discharge. The Ether fulcrum of pressure mediation between dielectricity in its counterspatial inertia and magnetism in its polarized (=creates space, motion) centrifugal divergence are merely complimentary and necessitated expressions of one radial inertia principle and divergence attribute both as a consubstantial whole.

As you can see below, even the magnetic hyperboloid is comprised of curvilinear radial lines that are vectorized as necessitated by discharged or transferred inertia. All energy archetypes are Ether modalities with attributional necessitated modalities of differentiation which distinguish them as unique but absolutely not separate in any way.

Below: All four ether modalities can be expressed simply and with clarity to the point that even a 10 year old might grasp it. The universe is not complex, it is simplex, however its compounded formations and Ether modalities are rapidly complex, never the less, the principles themselves are not.

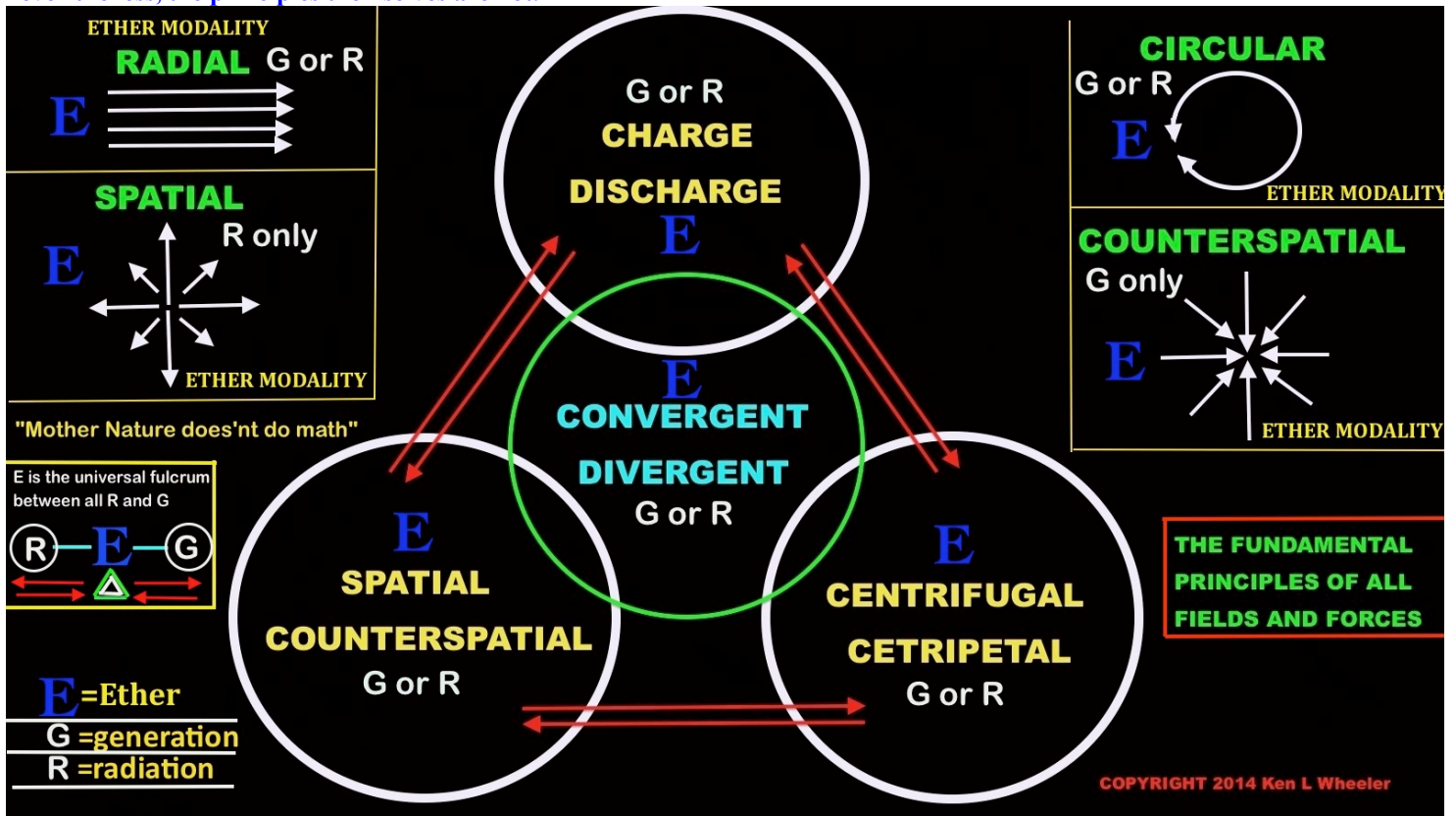

Below: As is seen, all Ether modalities can be expressed by radial lines of divergence, convergence, transverse, circulatory and otherwise attributional phenomena. The motional discharge and spatial vectorization govern the attributional qualities of this radial inertia as expressed in four different modalities.

ALL ETHER MODALITIES DERIVED FROM STRAIGHT LINES.
A SINGLE FULCRUM FOR OPPOSITE MOVING FORCES AND
FIELDS CREATES ALL MODALITIES OF ETHER MOVEMENT

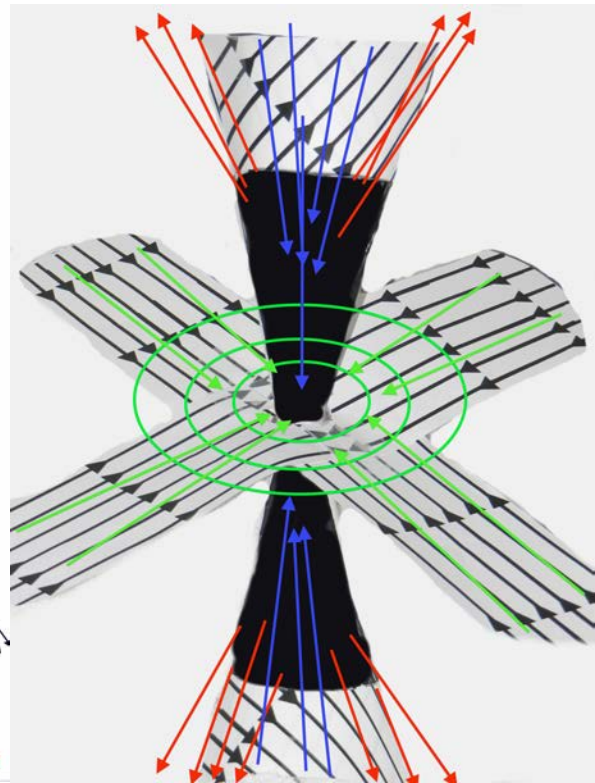
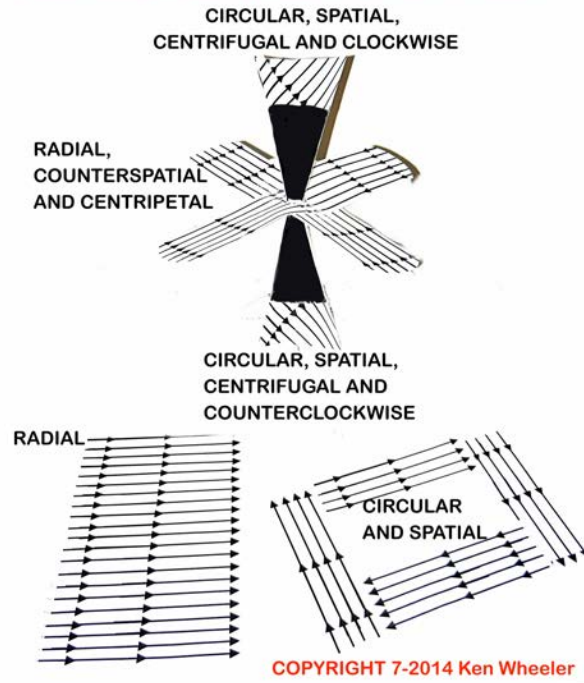

Below: Magneto-dielectric conjugate pressure formation analogous to the Ether pressure mediations as found within the “magnet” on left. On right, self-explanatory simplicity that must be grasped to have any fundamental comprehension of field modalities.

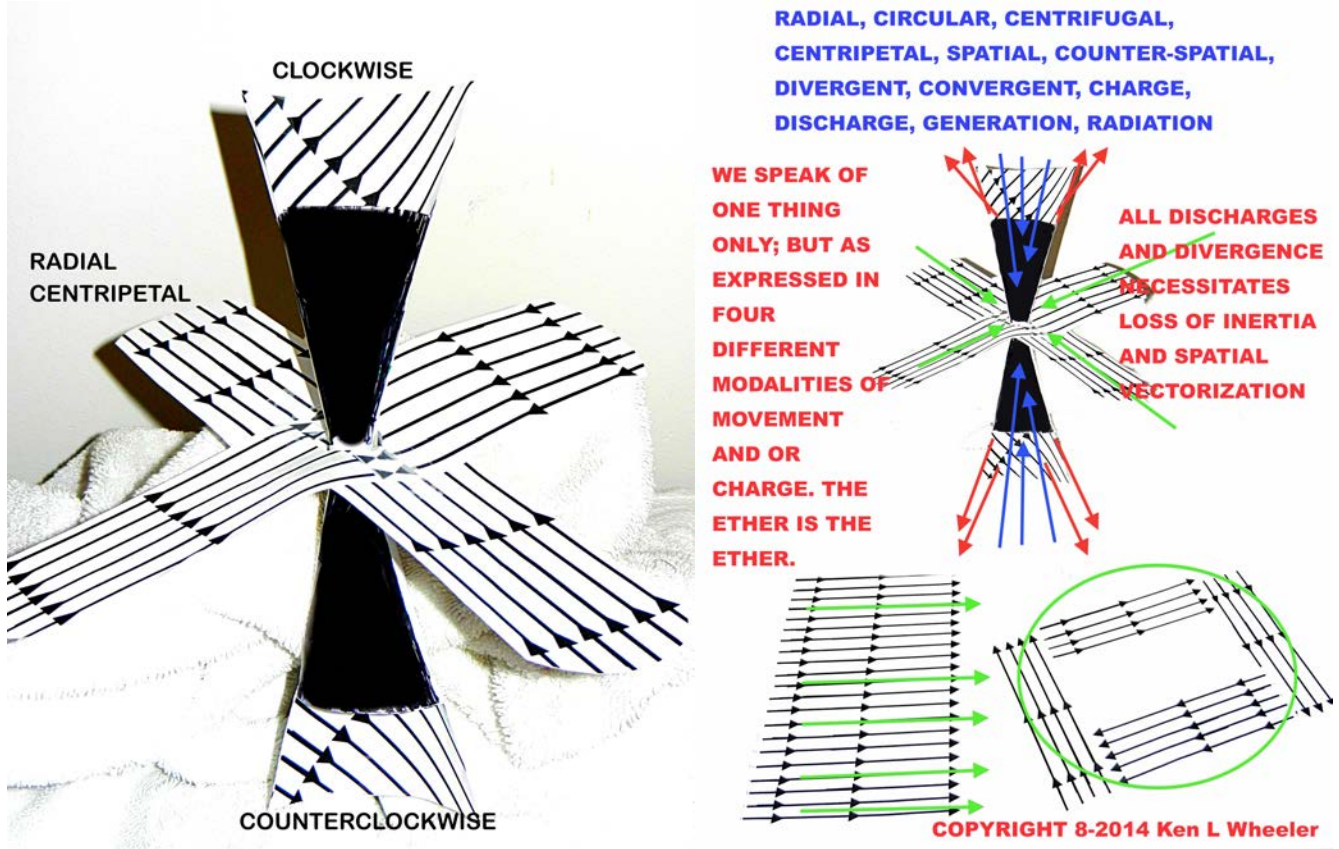

Below: New discoveries in vortex light and D.E.M. transmissions are unfolding rapid. Compounded data volume transfers are being realized at an exponential rate and are at the cusp of changing the world and communications.

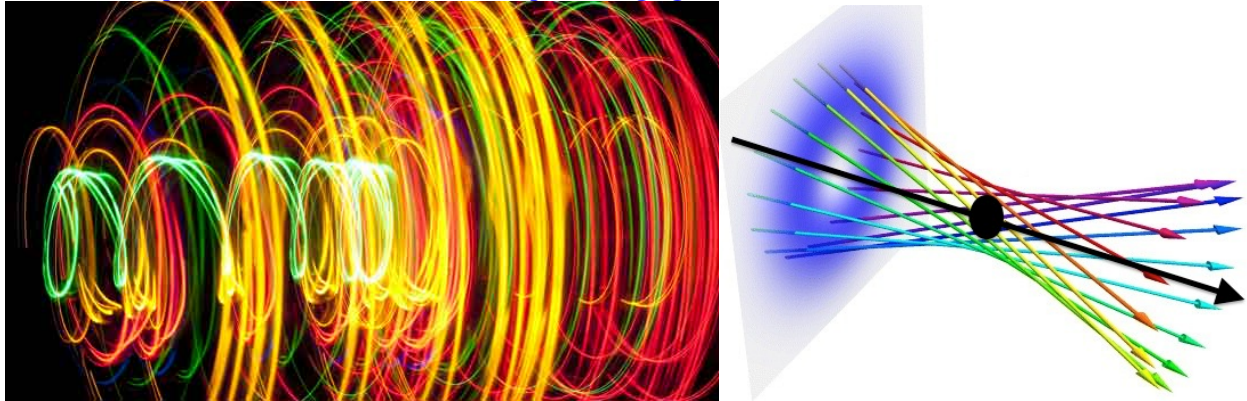

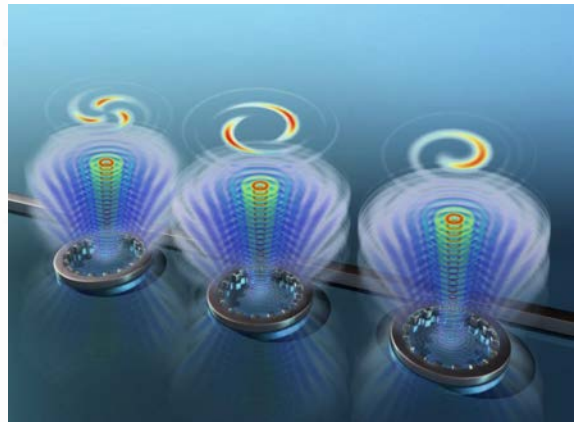
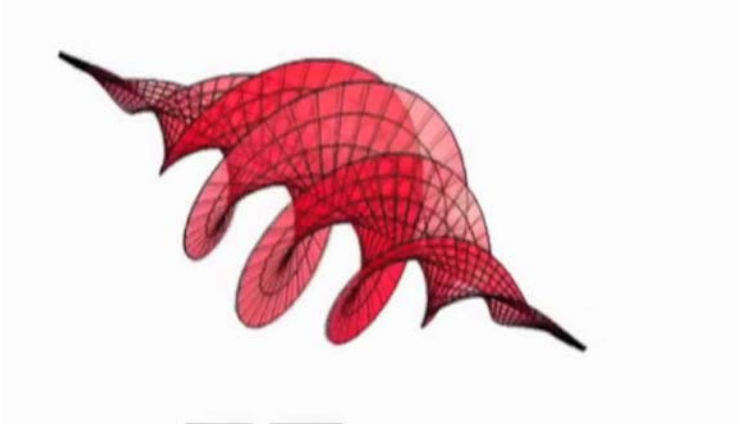

Below: Dielectricity, Ether inertia, is literally the line by which an extremely wide array of vortex and twisted hyperboloids can be created, both in magnetism, dielectric magnetism with its radial dielectric component, either visible, radio or otherwise. The future is only beginning in creating phased and unphased EM spectrum phenomena to change the future.

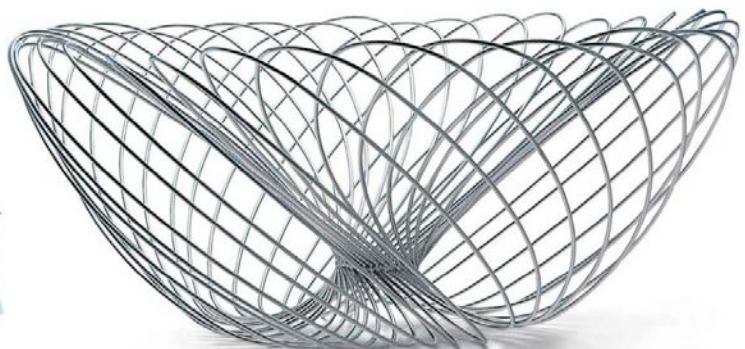
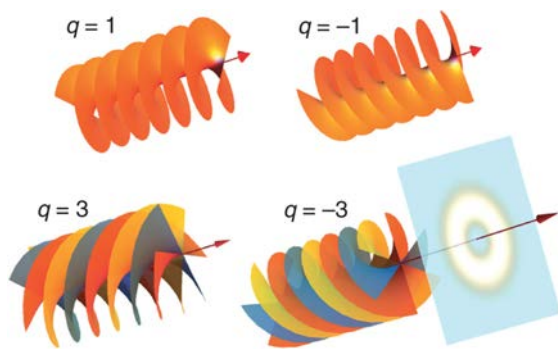

Below: All radial inertia Ether modalities find their pressure mediations, either as radial or longitudinal modalities or as hyperbolic dielectricity in discharge centrifugal magnetic hyperboloids or otherwise. If it cannot be illustrated or described by Euclidean geometry and math, it does not exist in nature. Quantum is a convoluted fairy tale.

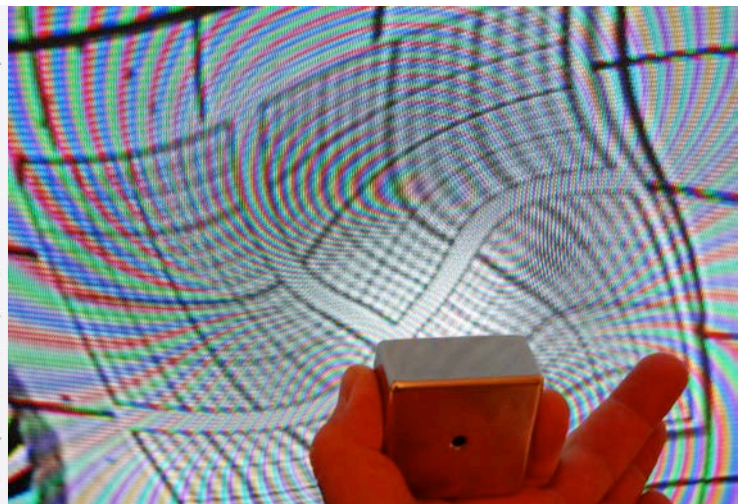
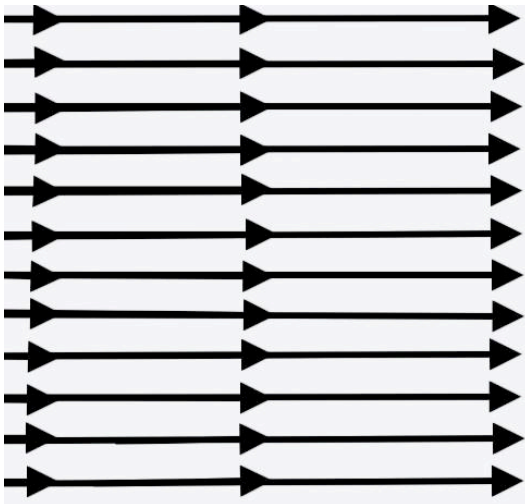

The RGB LED discovery of the dielectric voidance of light at the dielectric inertial plane of the ‘magnet’

Discovery copyright June 18, 2014 Ken L. Wheeler. RGB magneto-dielectric dispersion using the T. Vanderelli ferrocell invention.

As was predicted, tested and first discovered by myself, magnetism disperses the light with its Z-axis radial dielectric component just as the Faraday effect would predict it would, however even Faraday had no idea as to the reasoning behind this phenomena. The inventor of the ferrocell, T. Vanderelli, has been contacted and he has confirmed this phenomenon has never been seen before.

The blue light has higher dielectric pulses and capacitance as per (see later part of this book) the missing component of light, that being the Z-axis radial dielectric constituent of light. As for the blue light, there is much less of same is seen along either divergent poles of the “magnet”, which is why the blue light is almost not present along either pole. Second and third party testing has confirmed my discovery as was predicted to occur by myself. While the divergent blue light can be seen along the pole, the convergent magnetism has completely displaced the high dielectric capacitance of the blue wavelength light.

Below: On left, RGB LED cell, middle 3.1mm RGB element. Far right, greatly filtered light showing the RGB elements illuminated. Under normal viewing, the light is intensely white and there are no red green or blue elements visible.



Below: Blue light and green light have much higher dielectric radial capacitance in light from a great many more dielectric pulses than does red spectrum light. As such, as seen below, red light is very present around the “magnet” (divergent magnetism) whereas green far less, and blue further still much less to the point of barely being there requiring longer exposure times to be visible by the camera.

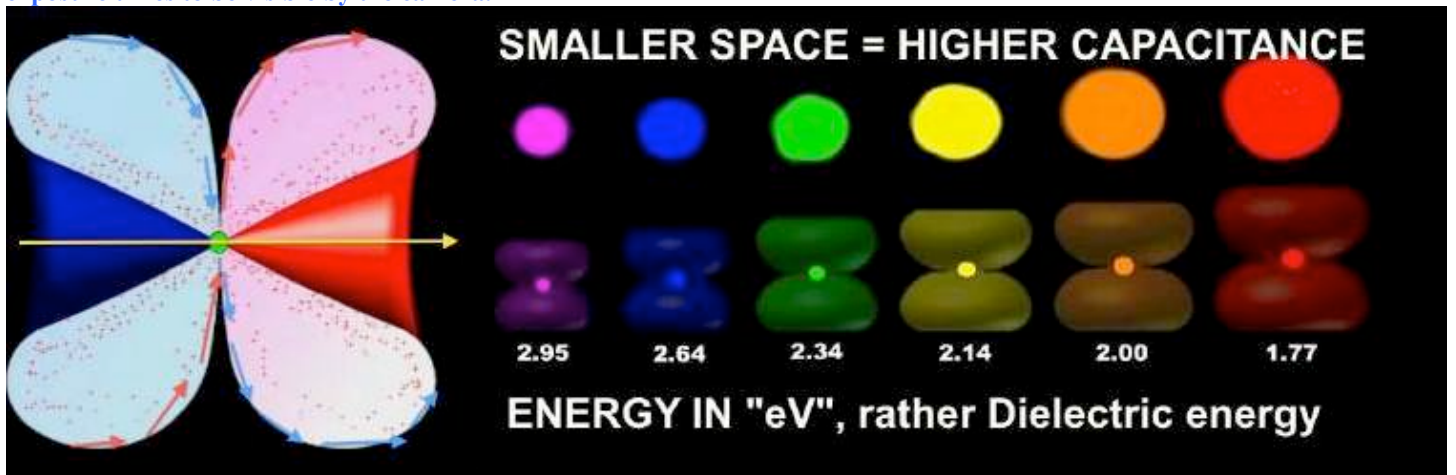

Below: As predicted and discovered by myself there is white light along the dielectric inertial plane of a N50 1" cube neodymium (any magnet as a matter of fact) and red and green light along the poles due their lower dielectric capacitance. Literally the three magneto-dielectric (convergent, divergent, and dielectric) pressure field-zones of the "magnet", the divergent centrifugal, the convergent centripetal, and the dielectric inertial plane have dissected the light into its relevant constituents based upon the magnitude of their dielectric pulse compositions proportional to wavelength. The invention potentials for this discovery have yet to be fully realized but are to be sure, enormous.

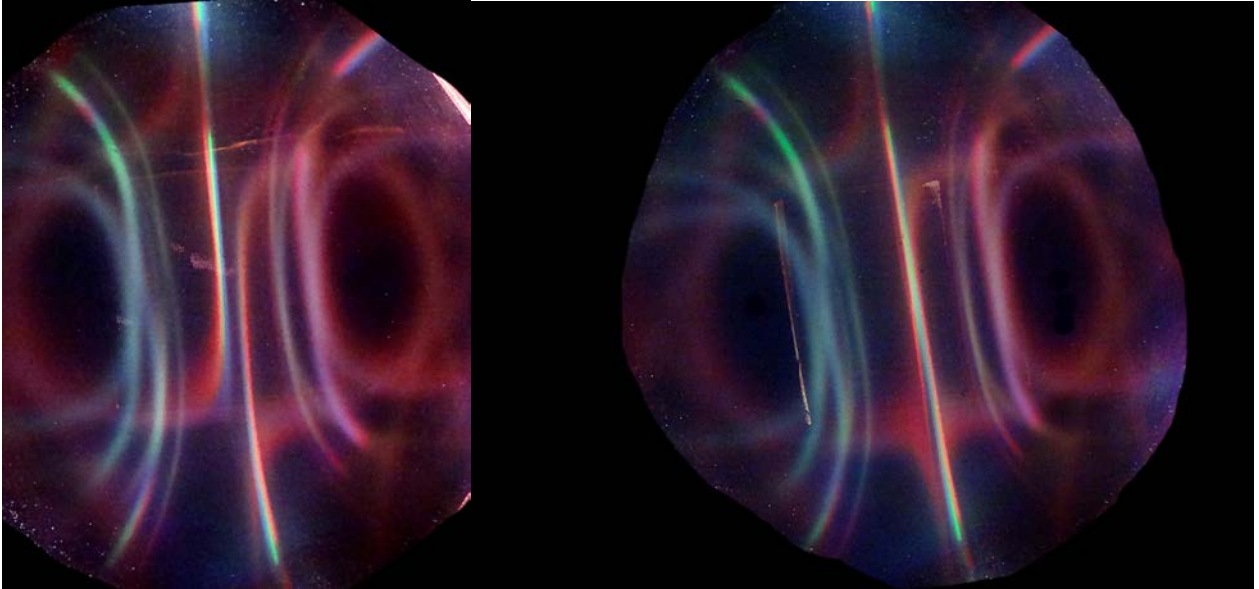

Below: On left very low light levels showing all light being brought along the dielectric inertial plane; both poles are left and right in the image. On right is blue light concentrated along the dielectric inertial plane and some visible along the centrifugal convergent point. All predicted by myself before testing, and perfectly logical once comprehension of the so-called "magnet" is fully realized.



Below: Left, green illumination, roughly a midpoint dielectric exposure between red and blue, and resultantly about a midpoint exposure of light between red and blue in what is absorbed along the dielectric inertial plane and centripetally as contrasted with the red on right with maximum exposure and low levels of dielectric pulses resultant to the red wavelength light directed upon the pressure zones of centrifugal, centripetal and dielectric inertial. Exposure times of the camera must also be considered in that the green and blue are both substantially more absorbed along the dielectric entry points of the 1" cube.

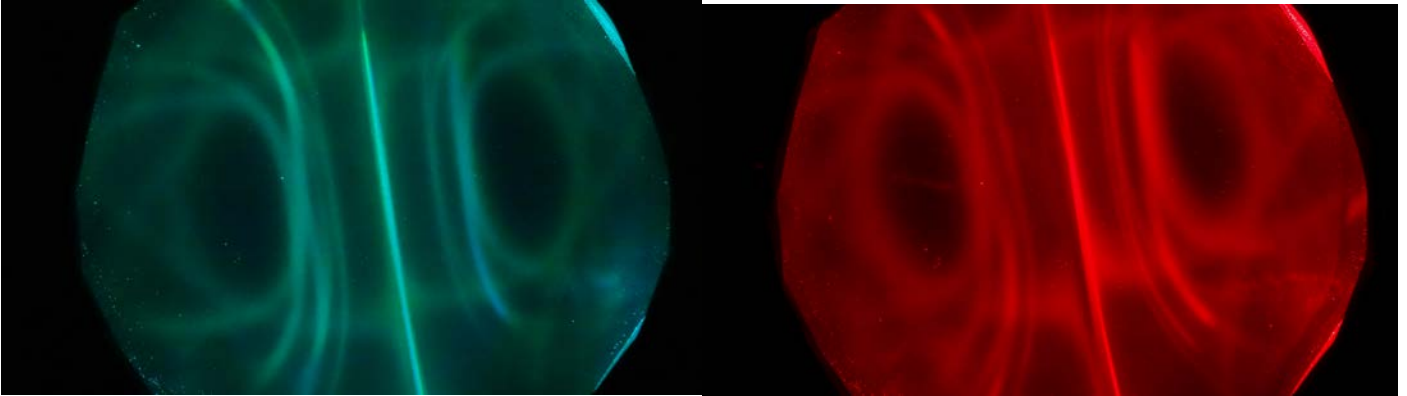

Below: Left and right cube magnets under the T. Vanderelli ferroc cell [Photo courtesy of Michael Snyder of revolution-labs.com]

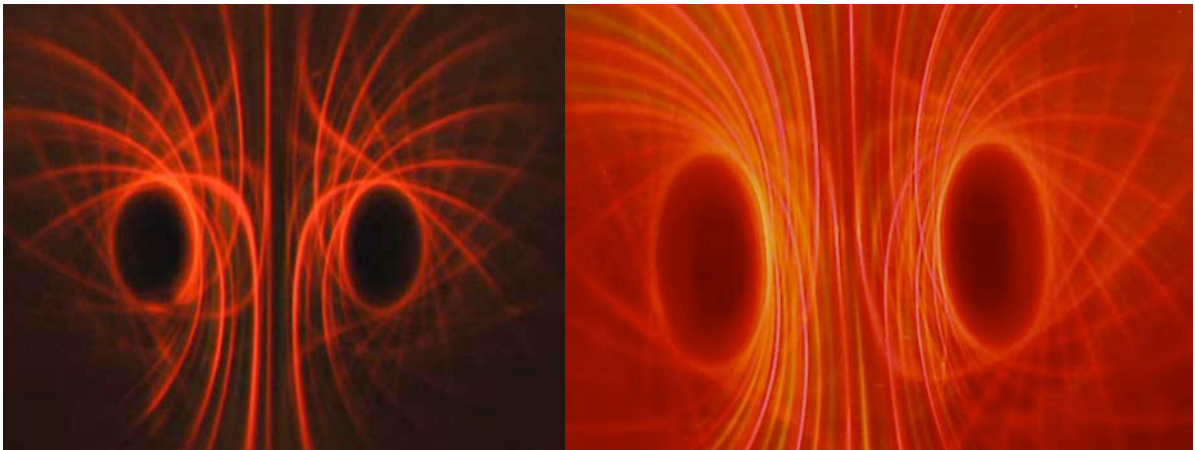

Below: Multiple magnets directed multi-colored LED light along the path of the dielectric inertial plane. You will notice the red and orange light still visible at the center however the higher capacitance green light vanishes quickly before reaching the centerpoint. [Photo courtesy of Michael Snyder of revolution-labs.com]

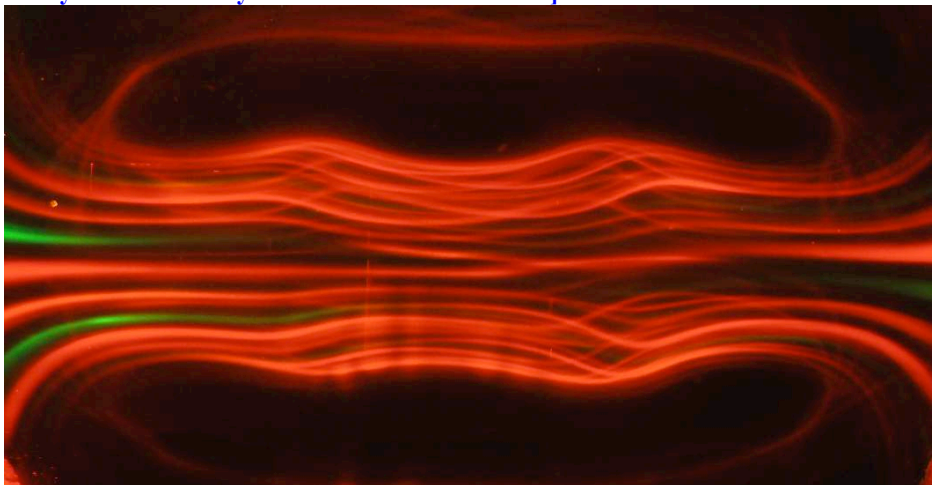

Below: Independent third party confirmation by Kris Lang of the RGB LED discovery. Photo courtesy of Kris Lang of Kirkland Lake, Ontario Canada. Turtle Island

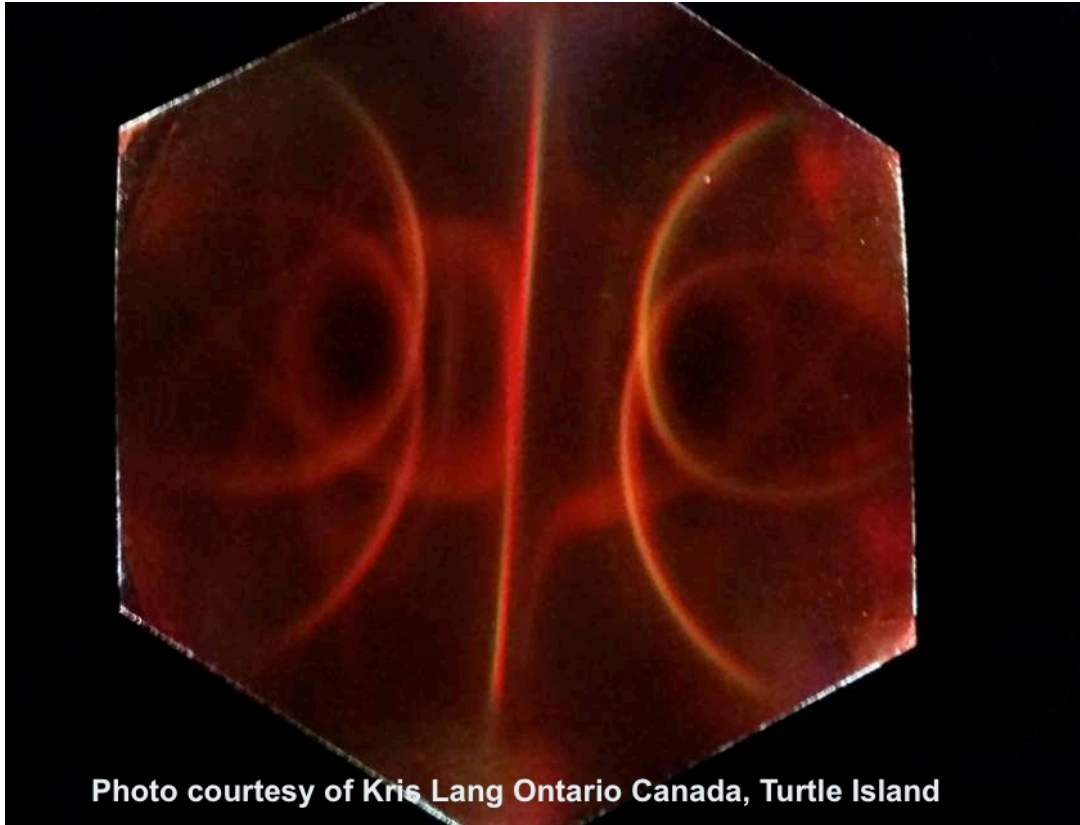

Photo courtesy of Kris Lang Ontario Canada, Turtle Island

Magnetism vs. Dielectricity, redefining the long-held nonsense of “magnetic attraction & magnetic repulsion”, or ‘the middle’

What have I illustrated below further than scientific ‘art’? The premise of comprehension that must be understood is that magnetism is not ‘driving’ any and all ‘magnets’; this ancient belief is pure uninformed insanity and illogical nonsense. Magnetism is the radiation, the hyperboloid spatial vectorization and polarization of dielectricity in discharge. Likewise further pressure mediation between objects that are merely under magnetic induction and dielectric coherency, which are therefore magnetically dominant while under induction mediate their pressures at full counter-voidance (repulsion) to the high dielectric capacitance as against the “magnet” against which they rest.

Inversely so to these objects, likewise “magnetic” objects with high dielectric inertia/ capacitance mediate their pressures along the dielectric inertial plane of the “magnet” against which they rest. This dielectric inertial plane is illustrated with a green line below in the images. In simplex, objects are either dielectrically dominant or under magnetic induction and have no increase in dielectric capacitance, only coherency, likewise further still have a forced decreased dielectric ‘presence’ while under magnetic induction, as such they are magnetically dominant in more ways than one, therefore only resting in pressure mediation perpendicular to the dielectric inertia plane where inertial resistance is absolutely minimal.

Below: 2x2x1" block neodymium, sitting on top is a disk magnet, on the side is a steel disk, sitting perpendicular to the dielectric inertial plane, bottom is a steel ring with a knife-thin edge also sitting perpendicular to the dielectric inertial plane. Middle picture is same but with the ring on the side. On the far right, a different angle of the middle picture. The dielectric inertial plane is marked with a green line.

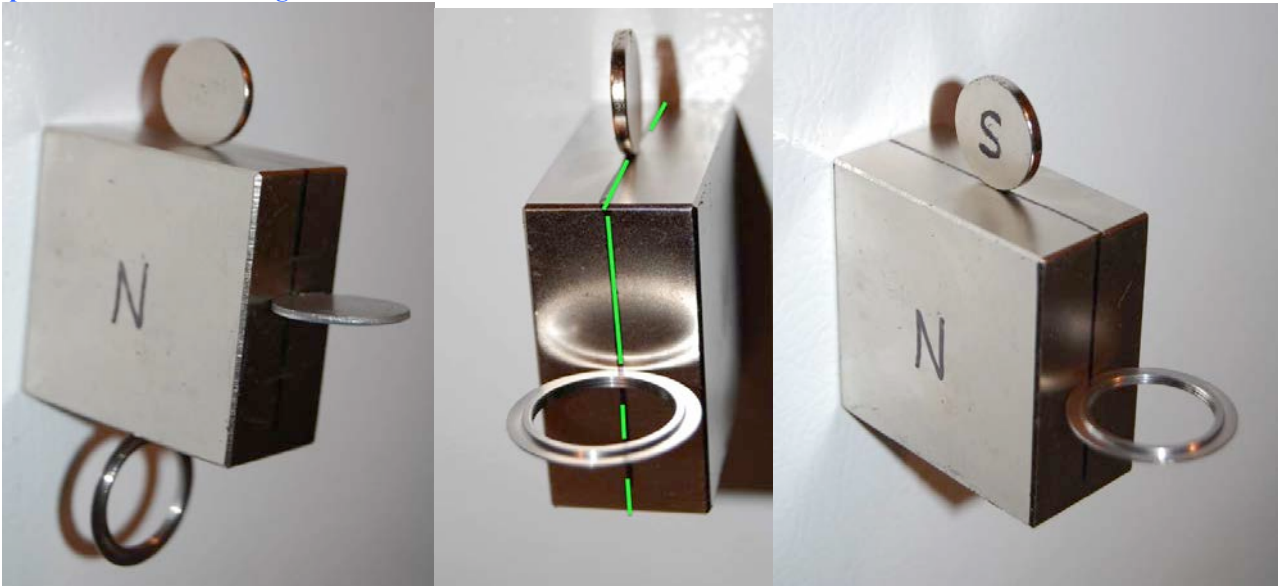

Below: Left is a 5/8" neodymium with a disk magnet in parallel to the 5/8" dielectric inertial plane, also a steel ring sitting perpendicular to the dielectric inertial plane. Middle picture, steel disk perpendicular to the inertial plane. Pictured on right is a large ring neodymium magnet with a 5mm ball neodymium on the I.D. with its inertial planes lined up with the ring magnets. Sitting on top is the steel ring sitting perpendicular to the dielectric inertial plane, and on the bottom right is the disk magnet sitting parallel to the inertial plane of dielectricity. The dielectric inertial plane is marked with a green line.

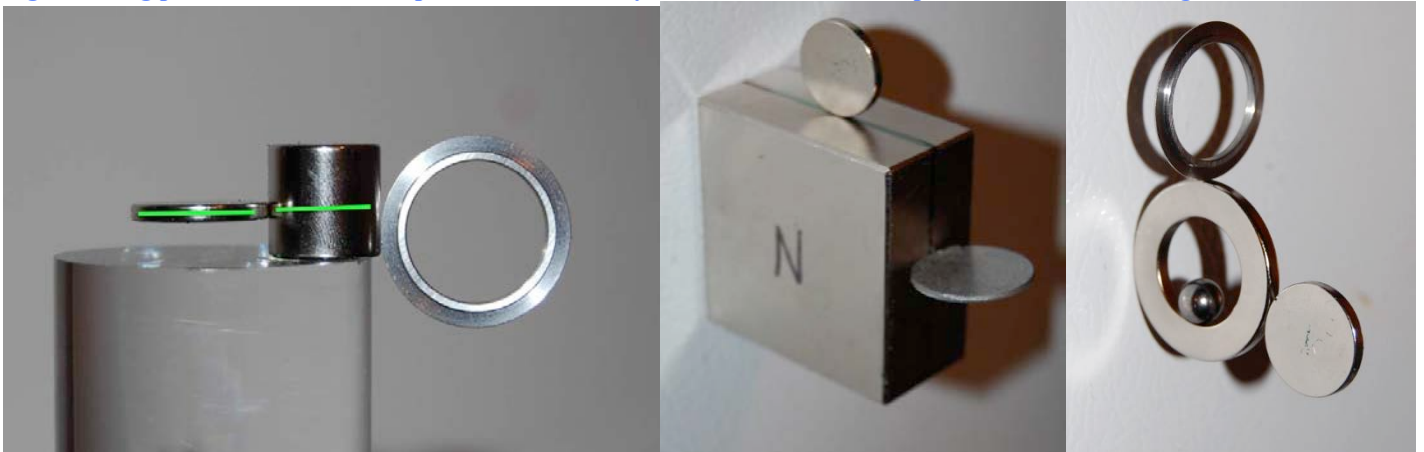

Below: 3/4" sphere magnet with its dielectric inertial plane marked, sitting at the angle of gyromagnetic precession. It is sitting on top of a large ring neodymium magnet. Atop the sphere is a copper coated steel ball to further show the gyromagnetic precession angle. Pictured on the right, are both the sphere magnet and ring magnet resting along each others dielectric inertial planes. So-called "magnetic attraction" is a complete lie and an age old perpetrated premise based upon the perceptual ignorance of magnets "attracting" steel and other ferrous bits. What is driving dielectric voidance ("attraction") is dielectricity. Magnetism does not attract, as a force, anything whatsoever, it only displaces and diverges, as is its nature of the Ether modality of divergent discharge, or radiation. The dielectric inertial plane is marked with a green line.

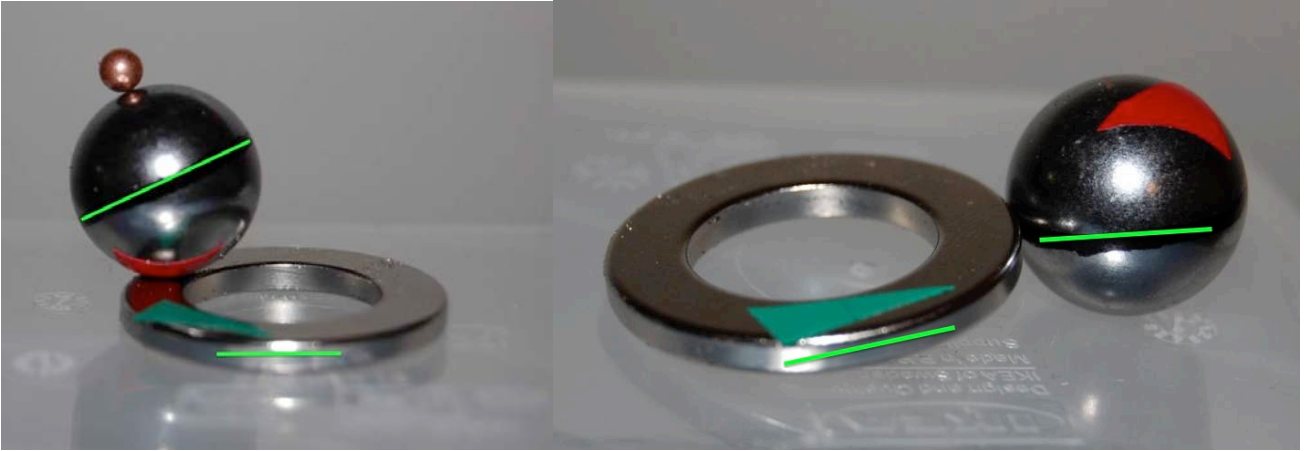

Below: 3/4" sphere neodymium and disk magnet sitting in perfect pressure mediation along their mutual dielectric inertial planes. Likewise on right, showing ϕ^2 contact as necessitated by gyromagnetic precession.



Below: Left, $\frac{3}{4}$ sphere neodymium sitting at the angle of gyromagnetic precession as it naturally rests with two steel balls on top to further delineate this angle. The entire neodymium sphere acts like one giant atom within any “magnet” except for the rotational precession that occurs as the hyperboloid does in magnetic divergence. On the right showing that gravity is irrelevant of any position of steel or neodymium regarding pressure mediation between what is merely under magnetic induction and therefore dielectric coherency and the disk neodymium which has both dielectric coherency and increased dielectric capacitance. Iron is literally, in analogy, a ‘rubber band atom’ which can store both higher dielectric capacitance, especially in a neo-iron-boron lattice, or iron can undergo simplex dielectric coherence while under magnetic induction which causes resultant dielectric capacitance.

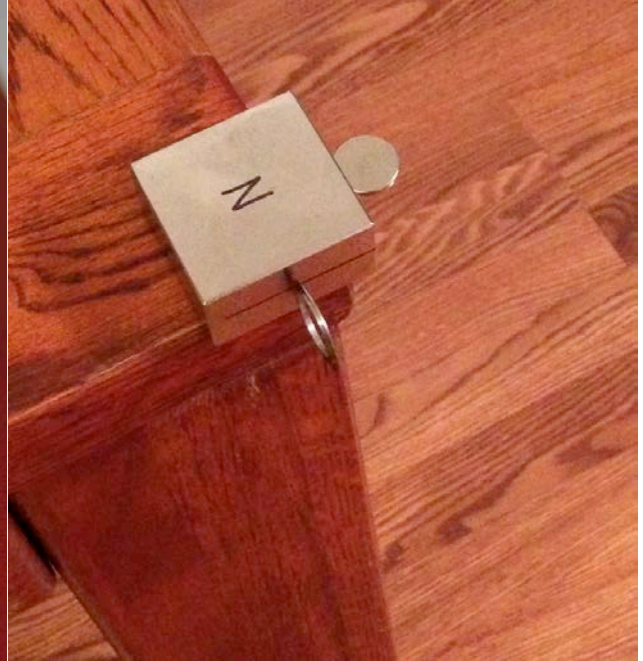
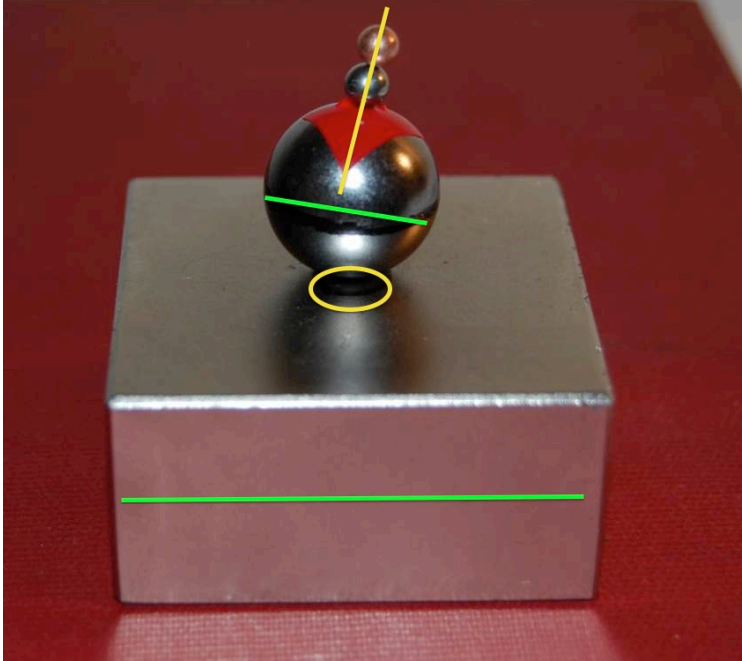

Below: Both artistic and interesting, the key point is to illuminate the nature of and differentiate the magnetic induction of steel with increased dielectric capacitance of a neodymium (or any “magnet”) wherein which field pressure mediation is 90 degrees opposite for both the steel and the neodymium along its adjacent ‘resting’ position. It cannot be stressed too much or often enough that the binding magneto-dielectric fields within the inter-atomic of all and every atom is expressed by and thru inertial planes of dielectric inertia and polarized pairs of magnetic hyperboloid forming hyperbolas.

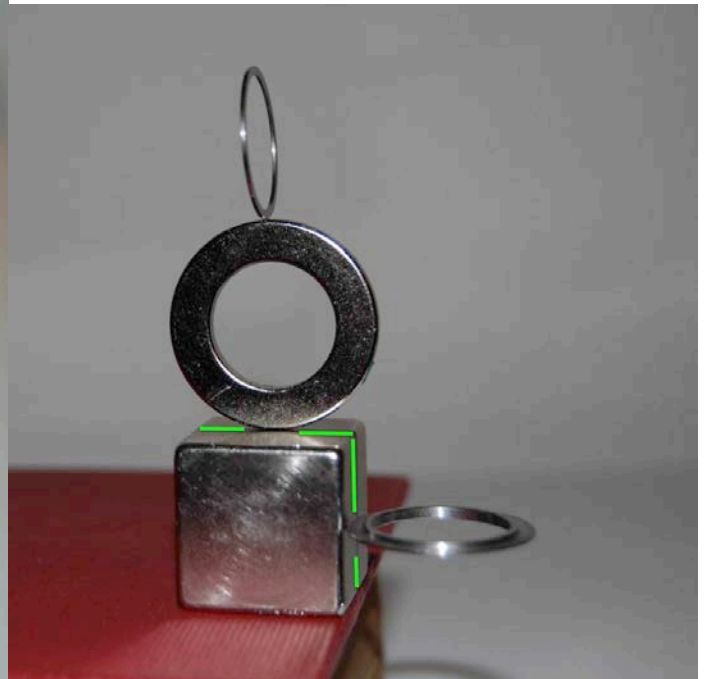

Below: Further examples of where magnetic induction finds its pressure mediation vs. high dielectric capacitance finds its pressure mediation along and or against the 1" cube magnet. The steel can only rest perpendicular to the dielectric inertial plane whereas the "magnets" can only rest in parallel to the dielectric inertial plane.

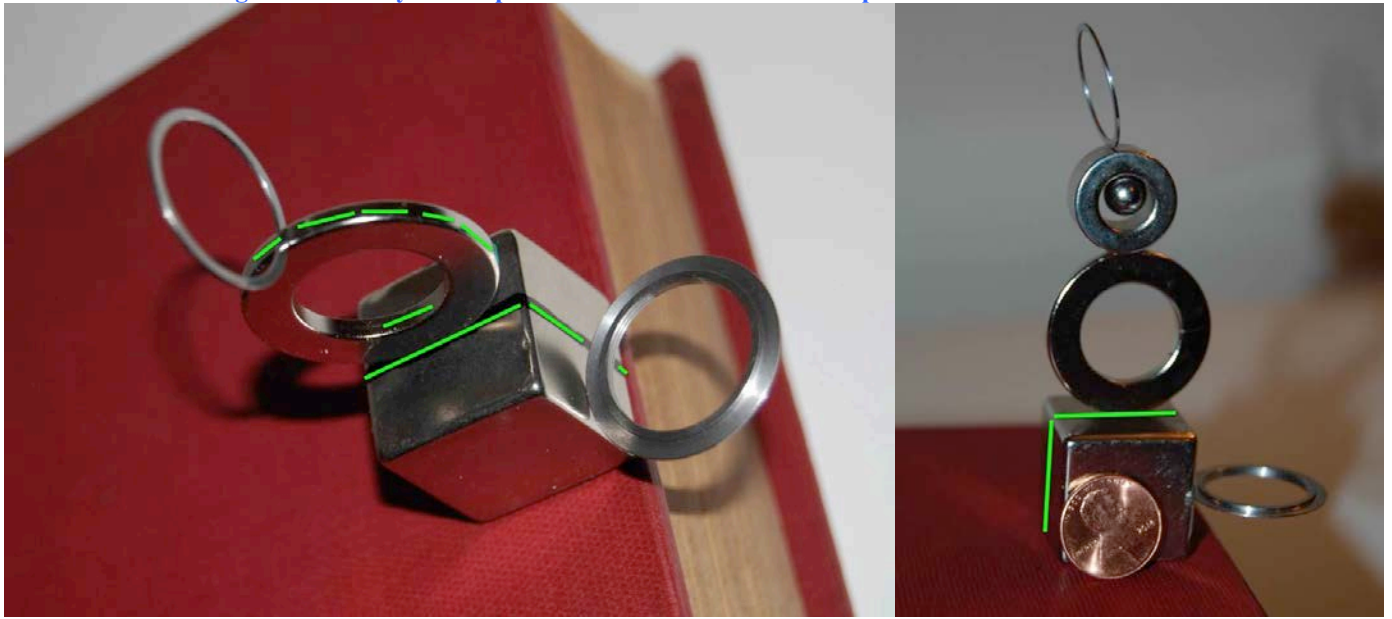

Below: When you understand how magnetism and dielectricity mediate out each others pressures the images below become lucid and clear child's play intellectually. On the right we have pyrolytic graphite resting on its thin edge against the divergent centrifugal "flow" of hyperbolic magnetism just like a stick in a stream will run end to end along the flow of the stream and not crosswise, or against the pressure flow.



Below: Pyrolytic graphite easily balanced along its edge in line with the divergent centrifugal magnetism to which the diamagnetic pyrolytic graphite is repulsed due to high order dielectric inertia within the carbon crystalline lattice of the graphite.



Below: Bismuth disk's final resting place, perpetually ending at the same spread leaving the same golden ratio attraction (voidance) and countervoidance (repulsion) position along the 2"x1" cylinder neodymium. This harmonic precession always finalizes in the same location due to mutual pressure mediation between the diamagnetic bismuth and the centripetal convergent point of the cylinder neodymium. Contrary to popular conception, bismuth, the universes most diammagnetic element, is as 'attracted' the so-called magnet as is steel, however the expression of same must take into account its very low magnetic permeability.



Below: Valid perpetually repeatable results of spinning a bismuth disk on top of any magnet that its circumference will not stray from the centripetal convergent point of any “magnet”, and will likewise rest on this edge, in perfect pressure mediation of the bismuth’s diamagnetic counter-voidance of its extremely high magnetic reluctivity and likewise its dielectric permittivity as expressed by its voidance at the centripetal convergent point of the “magnet”. This is always a mutual golden ratio expression; in this case Phi (1.618033) and 1/Phi (.618033).

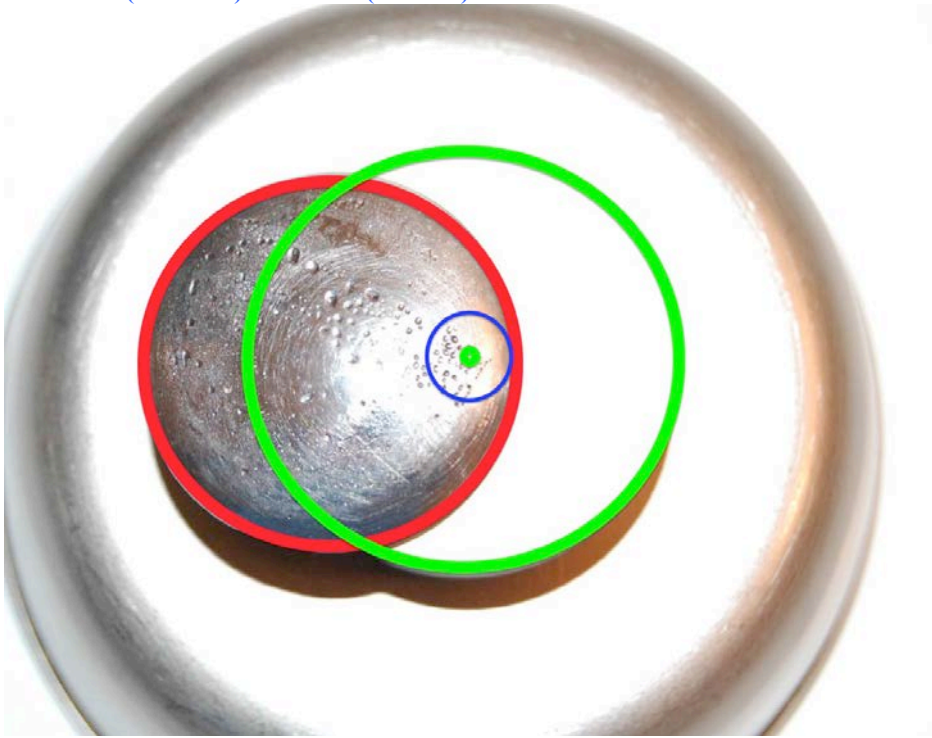

An analogy, both of the “magnet” and human ignorance

In the "magic faucet" amusement, there is a meaningless faucet seemingly hanging in the air with no source for its water nor its support; it constantly pours out water, contrary to conventional visual views and logic, it is amusing to watch. Of course, what is holding up this faucet is a clear plastic tube within which water is being pumped up thru the tube to just inside the faucet, and then over the edge it flows via gravity outside the clear tube, both occluding the clear tube from view and making it seem that water is only pouring out, rather than up and into the faucet. All of this is driven by an electrical water pump hidden in the pool, which is not visible.

In a “magnet”, the "pump" driving the magnetism (water), which flows, is the dielectric inertial plane concentrated and focused at the center (actually its everywhere, but forced to the midpoint by incommensurate magneto-dielectric geometry of opposite fields in a binding system, the "magnet". As such dielectricity is NOT 'located' at the center.). While in the case of the “magic faucet” amusement, gravity is causing the resultant convergence back to the pool from which it was pumped, in the case of the “magnet”, convergent return of the ‘dielectric field’ (i.e. magnetism) is driven by simplex pressure mediation of the reciprocating and “flowing” divergent radiation that is magnetism resultant from the point non-specific dielectricity either coherent or increased dielectric coherence, as present all throughout the physical “magnet”.

Below: The “magic faucet amusement”. Water is being pumped from an unseen pump in the pool up through a clear tube to just inside the faucet and allowed to pour out around the tube via gravity. What is driving magnetism is not magnetism, rather dielectricity, and this is the “charging pump” within each and every magnet. Whether the “magnet” was created via mere induction from a powerful magnet or created by increased dielectric capacitance makes no difference; the resultant in the same.



Simplex human stupidity only “sees the waters” (magnetism) even a more intelligent person who knows how this trick works, only “sees” the water, and while knowing how it works, is amused at and by the spatially flowing (in our case, magnetic fields) demonstration. All flow, all radiation, all discharge, is driven by a **charge, a prima causa**; in the case of the magnet, dielectricity, and in the case of the amusement, an electrical water pump which is hidden. Therefore, as is the case, dielectricity is radial, centripetal, counterspatial, inertial, and its very nature is “hidden” as well. Dielectricity and magnetism are the two co-principle conjugate Ether modalities in the universe, one is charging, the other discharging, one is counterspatial, the other spatial. One is inertial, the other is circulatory. Contrary to conventional logic, as per fields, increased movement is decreasing inertia and implied of magnetism in discharge. Likewise decreasing movement is increasing inertia and implied of dielectricity in charge or centripetal convergence. The stasis of inertia requires discharging magnetic polarization and resultant vectorization as space (not into space) to maintain the conservation of Ether inertia in the dielectric.

Dielectric coherency (in a soft magnet) or dielectric capacitance increase from discharging coils results in the unique magneto-dielectric coherent pattern as seen in so-called “magnets”. In both cases, the resultant radiation (magnetism) has been either made apparently polarized (magnetism is always polarized definitionally so, but is in disorder and incoherent between normal atomic matter inside the interatomic) or both coherently polarized and increased; **likewise any coherency of one necessitates the coherency of the other**. Amusingly, in the creation of a powerful magnet from discharging coils in which capacitance is increased, we are “feeding our horse” (dielectricity) with more food/charge, we likewise expect resultantly a ‘much larger discharge’ from the ‘other end(s)’, in this case radiative high gauss ratings of divergent discharging Ether fields, as meant our magnetism.

Contrary to popular conventional thinking, a higher gauss magnet does not have a “longer reach” in magnetic effects, rather in fact a SHORTER ONE SPATIALLY as is both logical and necessitated. A higher dielectric inertia necessitates a more and more, or increasingly spatially shallow magnetic vectorization to maintain this dielectric inertia. Likewise a LOW VACUUM pressure has a greater spatial effect than does an extremely HIGH VACUUM pressure. This is high counterspatial dielectric inertia expressing its fundamental discharging magnetic polarization with a more shallow spatial gauss flux phenomena. The higher the counterspatial ‘vacuum’ the smaller the spatial aperture. The lower the counterspatial ‘vacuum’ the larger the resulting spatial aperture.

Below: Prima Causa is the last and ultimate allegory. It derives from the ancient Platonic idea of the 'Unmoved Mover' a. First Cause is no cause, only attribute. This discovery from ten years ago is $1/\Phi^{-3}$. There can be no first cause definitionally.



No fields can, have ever, will never terminate “in space”. This is the cornerstone of J.C. Maxwell, C.P. Steinmetz, Tesla and others, and is accurate. Space is a terminal for nothing, and of nothing. Space has never “done anything”, nor caused anything. Space is the posterior attribute of fields. As such, no field can "terminate into space", they can into themselves and other fields, but space itself has no capacitance other than the inductive ability granted it by the field(s) to which it is a byproduct thereof.

Divergence and Convergence as a model of dielectric discharge, magnetism, and centripetal convergence

One of the best analogies to understand magnetic divergence and convergence is its counterpart in nature, pressure flow mediation in the atmosphere. Additionally it helps (or should) you understand that the four counterparts of mutual pressure flow (dual inverse spin convergence and dual inverse spin divergence) typify one system of magnetic pressure mediation, centrifugal divergent, centripetal convergence, reciprocation, and inverse spin/flow. Just like the air in divergent and convergent weather, we have one Ether, with four modalities, however expressed dually in the so-called “magnet”; that being dielectricity, and dielectricity in discharge, i.e. magnetism. As has been said many times, nature gives you the answers to all its system in other systems; you only have to have open eyes and clear minds to see the obvious.

Below: One can just as easily rationalize the trough axis in a weather system of air pressure with the dielectric inertial plane where mutually divergent and convergent systems both move from and towards each other in mediating field pressures, or in this case air pressure. Below is merely a different modality of natural expression of what occurs, but not comprehended until now, in and of the permanent magnet. Obviously so the earth cannot have simultaneous high pressure everywhere or inversely low pressure everywhere, nor can a magnet be a 'one way fire hose' of magnetic centrifugal divergence. Magnetism, or dielectricity in discharge cannot exist independent of its source and is necessitatively reciprocating upon itself.

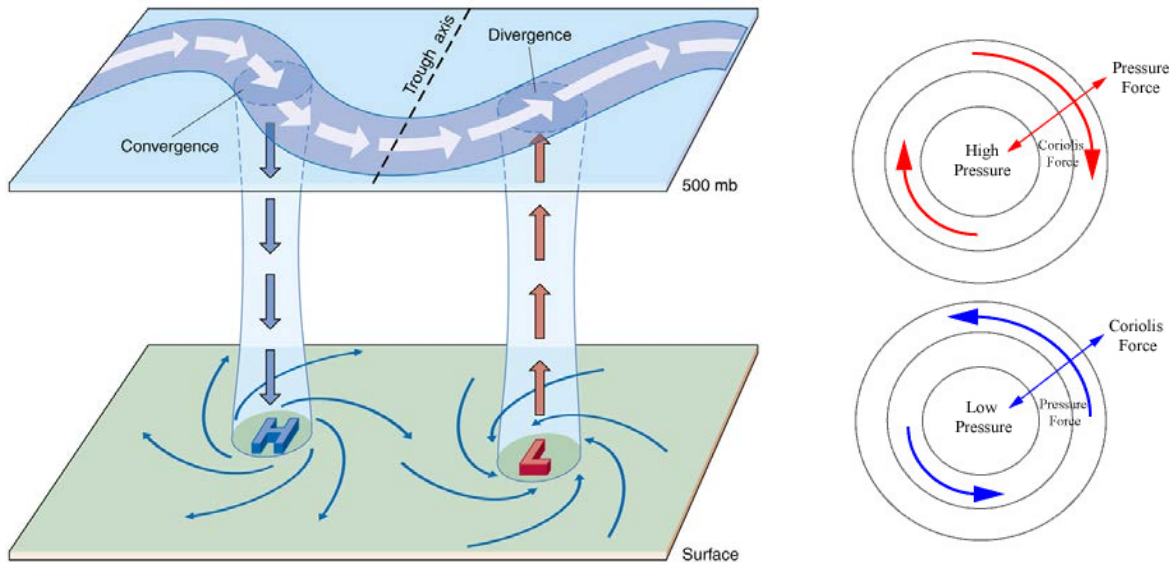

Whereas in the case of the sun warming various parts of the earth unevenly due to reflectance, day and night heating and cooling, we have a perpetual quadrapolar divergent-convergent system of pressure mediations wherein which the earth's atmosphere is perpetually self-adjusting its own pressures resultant to expansive hot and contractive (centripetal convergent) air movements, the sun's heat, and many other factors. As any gauss meter will register to you, the highest pressure points on a magnet are its divergent centrifugal edge, and secondly its convergent centripetal point at the center of every polarized side.

Below: Global daily cooling and heating drives, like a 'magnets' dielectric inertia does, a system of perpetual pressure mediation.

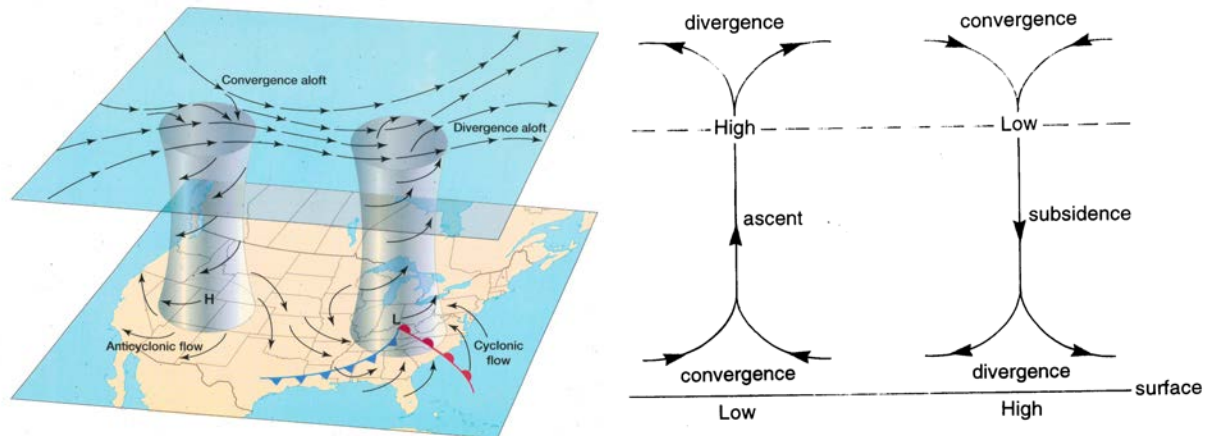

Magnetism is the necessitated spatial expression of inertia loss of dielectricity which causes spatial reciprocation as the Ether modality of magnetism after which time it must terminate where dielectric voidance is lowest, centripetally on the other pole. Even divergence must discharge its own spatial divergence since it has no energy of its own, only as impelled to divergence by the dielectric in discharge which initiated the centrifugal discharge.

Below: Likewise as a magnet, we have high-pressure atmospheric divergence and low-pressure convergence both necessitatively due to pressure, and likewise is the case, that no line of field flux can or may terminate in space, it is impossible.

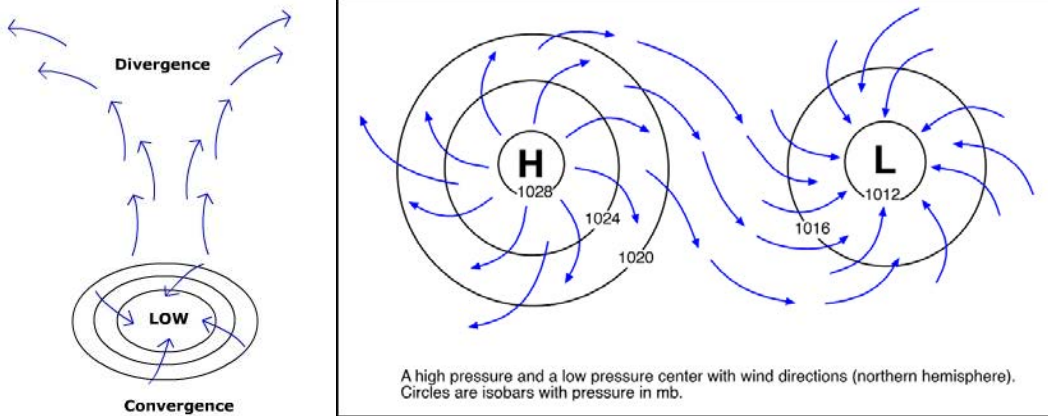

Below: While spatially separated in location, you can imagine both surface convergence and surface divergence existing mutually as a necessitated pair on both poles of every 'magnet' that exists. Every 'dipolar' magnet is in reality a quadrapole with each pole having both necessitated divergence at the edge of centrifugal magnetism and necessitated convergence at the center of centripetal dielectric voidance and inertial reintegration. Superluminal spinning trillions of coherent atomic 'magnet' nuclei are the impetus for the inter-atomic magneto dielectric principle of atoms which, in the case of the 'magnet' is coherent and has enormous macro-atomic phenomenal effects.

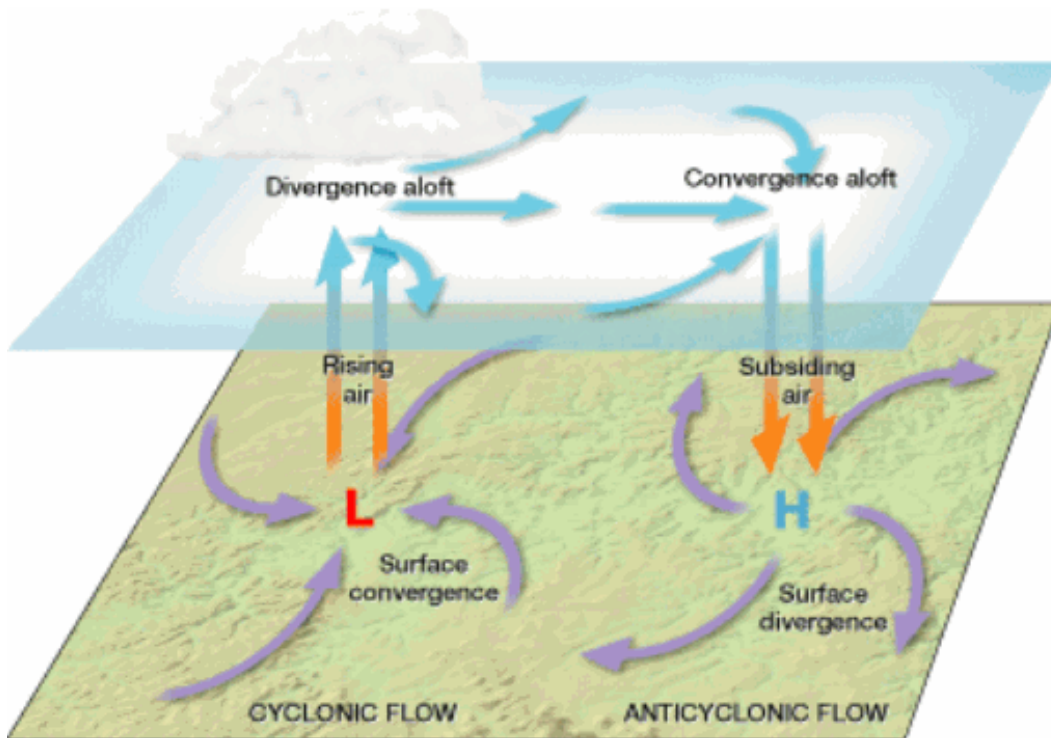

Dennis Tasa

Below: While mutual quadrupolar divergence-convergence is necessitated in total, with both existent on either pole, it is necessary to understand that magnetism is not driving magnetism, or are divergent and convergent weather patterns of air movement driven by air movement. In the case of the earth, it is perpetual heating and cooling from daily day and night heating and cooling cycles, likewise the case with the presumed 'magnet', which is driven by coherent dielectric inertia, which in discharge necessitates divergent magnetism and convergent re-integration, or dielectric voidance.

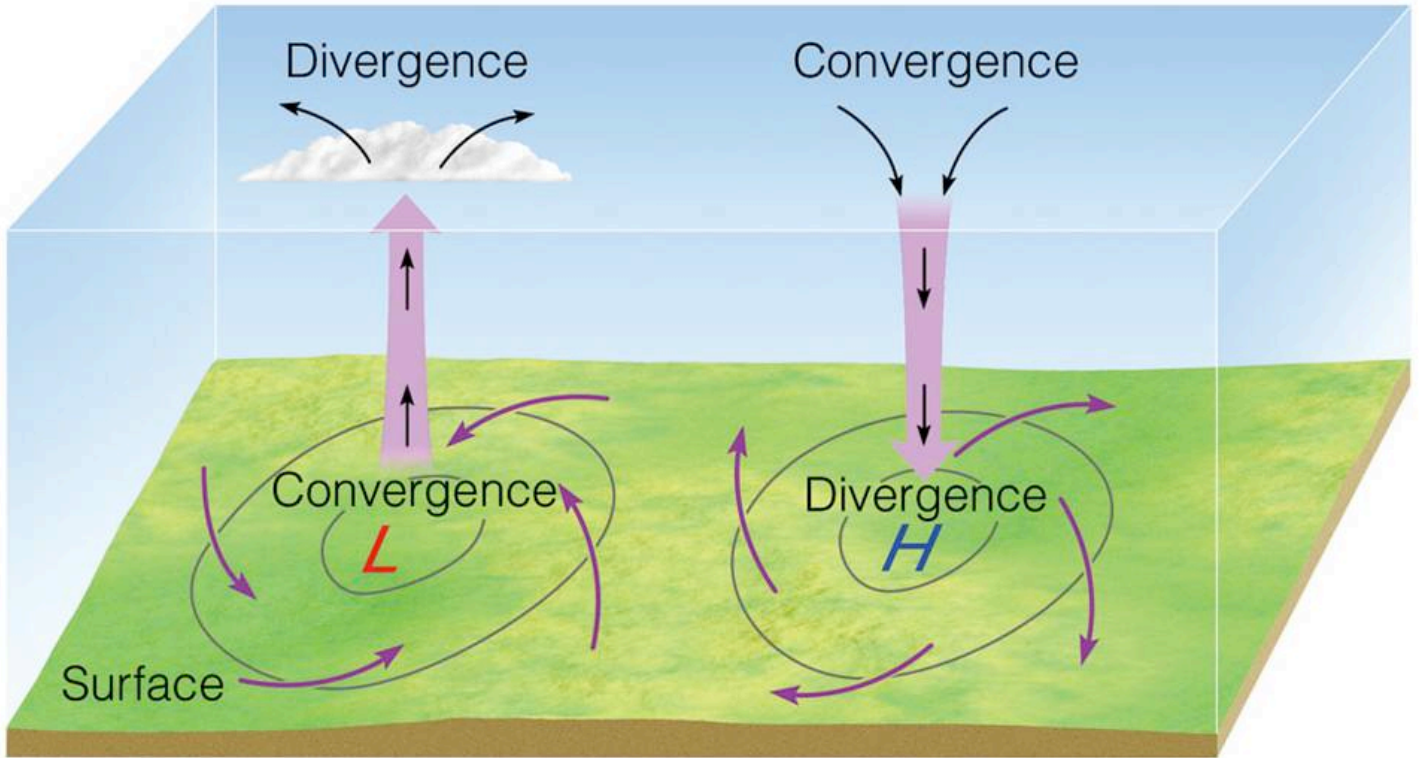

Below: Every pole of every magnet has a centrifugal divergent anti-cyclonic pressure zone and a centripetal voidance zone of cyclonic pressure. Field pressure self-regulation is the Ether fulcrum of inertia within which discharge causes the creation of space resultant to magnetic fields, and this causes additionally, a loss of inertia and cyclic discharge.

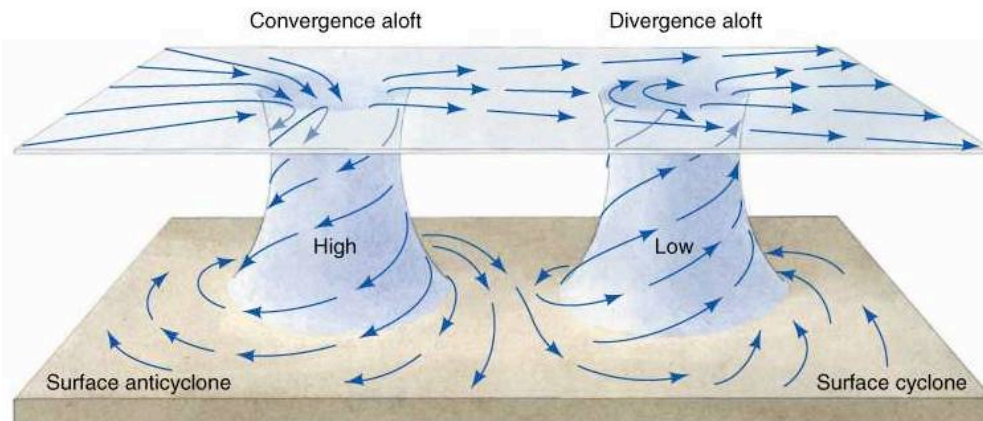

Surface isobars as they appear on a map

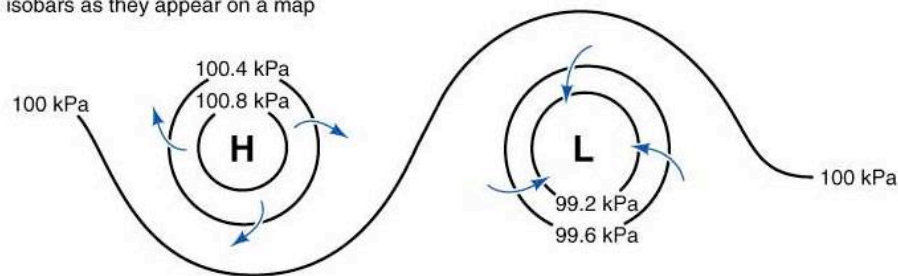

Below: On the left we can imagine the dielectric inertial plane of every ‘magnet’ within which the magnetic breaking induces the perpetual circuit of magnetic divergence, upon which discharge feeds same and the cycle repeats endlessly. The ‘magnet’ is a literal perpetual feedback loop of magneto-dielectric self-mediating harmony and field pressure reciprocative perfection.

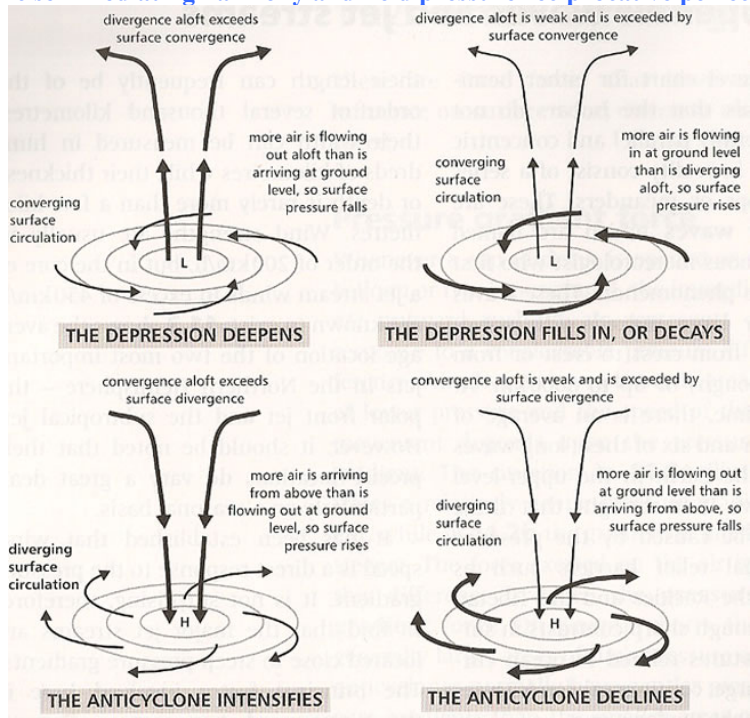
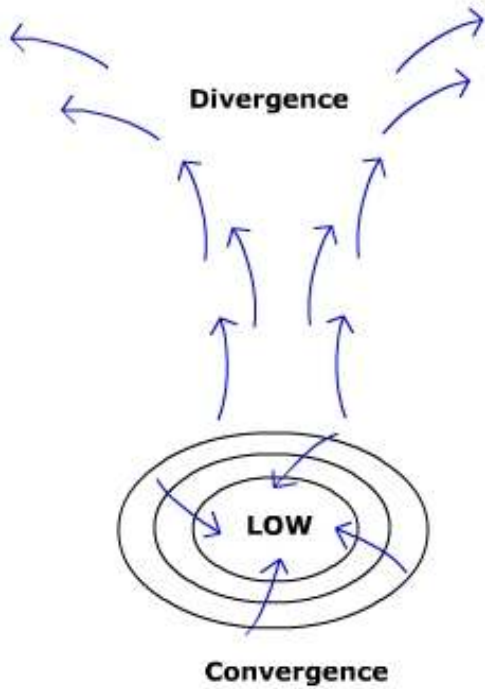

Below: If you can understand how pressure mediation works in empirical models, you can understand same in Ether modalities. Divergence necessitates convergence, and unlike other natural phenomena, fields cannot terminate in space, rather only upon themselves or affectively upon another field. Likewise all polarity is radiation, and in a single binding system, inverse relative polarity spin is not only always observed, but absolutely necessary without exception.



Proof that magnetic centrifugal and centripetal reciprocations follow the golden ratio and are a system hyperboloid of Phi cubed

The math of the magnetic vortex is just expanding and contracting interlacing singular system of a dielectric hyperboloid, composed up of divergent polarized (definitionally obviously so and necessitated) radiation and convergent dielectric voidances at the centripetal point of both polarized spatial divergences ('poles'). The lowest possible pressure mediations necessitated by and thru opposite field modalities, divergent and convergent, and gyromagnetic pressure precessions, can only be expressed by phi and a dielectric hyperboloid.

Below: My formula and discovery for calculating the MEAN FIELD divergences, and convergence of the idealized magnet.
Copyright discovery 7-28-2014 Ken L. Wheeler

MAGNETIC & DIELECTRIC FIELD FORMULA

C3radius x .23606 = C4radius (centripetal boundary)

C3radius x .381966 = C1radius (dielectric boundary)

C1radius x 3.23606 = C2radius (centrifugal boundary)

C2radius = spatial divergent boundary

C1radius X 3.23606 (Phi+Phi) = C2radius

C1r+C2r = Phi cubed

GYROMAGNETIC PRECESSION, MOVEMENT = Phi^-3 (.23606)

C2+C3=Phi cubed

C1r+Phi+Phi=Phi cubed

L to H, or H to L must approximate close to 1 to Phi, or Phi to 1 cube and sphere magnets are exempt from this limitation

INCOMMENSURATE Phi cubed, Phi^-3, and 1/Phi^-3

COPYRIGHT 7-28-2014 Ken L. Wheeler

Below: Mathematical proof that centripetal contracting fields “draw out” convergent spheres of a vortex-toroid, and centrifugal fields “draw out” expanding divergent vortex-toroid hyperboloid spheres. This golden section ratio of divergence and convergence is convergent centripetal fields = centripetal radius of 1; and centrifugal divergent fields are a radius of centripetal-1-value times (Phi+Phi [3.23606]). Or: (C1radius x 3.23606 = C2 radius) which all together = Phi cubed (C1r+Phi+Phi = 4.23606). Phi in the circle = golden angle of 137.5077 degrees. 1 in the circle = C1 radius which is 85 degrees. Copyright discovery 7-28-2014 Ken L. Wheeler

INCOMMENSURATE MATHEMATICAL PROOF OF MAGNETIC CENTRIFUGAL AND CENTRIPETAL RECIPROCATION
DISCOVERY 7.28.2014 KEN L. WHEELER

RADIUS C1 x (Phi+Phi [3.23606]) =RADIUS C2 [3.23606 +1 = Phi Cubed]

1 + Phi + Phi = Phi CUBED = 1/Phi⁻³

C1 = CENTRIPETAL
C2 = CENTRIFUGAL

PHI CUBED

1/Phi⁻³ = Phi cubed = incommensurable reciprocation of magnetism

PROOF MAGNETIC RECIPROCATION FOLLOWS THE GOLDEN RATIO IN PERFECT PROPORTIONALITY

COPYRIGHT 7-2014 Ken L. Wheeler

Below: Extrapolated convergent magnetism and in the middle, convergent and divergent magnetism. On right, the 5+Phi⁻³ discovery of field incommensurability known, but empirically demonstrated. Copyright discovery 8-8-2014 Ken L. Wheeler

Below: Nature's golden section of pressure mediation by fields is applicable to all simple things in nature as well. Any aspect of nature which does not follow the golden section is merely a compounded product of two or more interlacing or converging golden sections (typically very many).



Below: Left, $\frac{1}{4}$ cube magnet under the ferrocell showing the hypotrochoid polarized hyperboloid of centrifugal magnetism. Likewise the same in the middle picture and on the right, the 137.5077 angles of growth, divergence, and spatial movement. This simple formation is the basis of all dielectricity in discharge, i.e. magnetism and of natural growth, phyllotaxis, galactic formations, and DNA; the list is virtually endless.

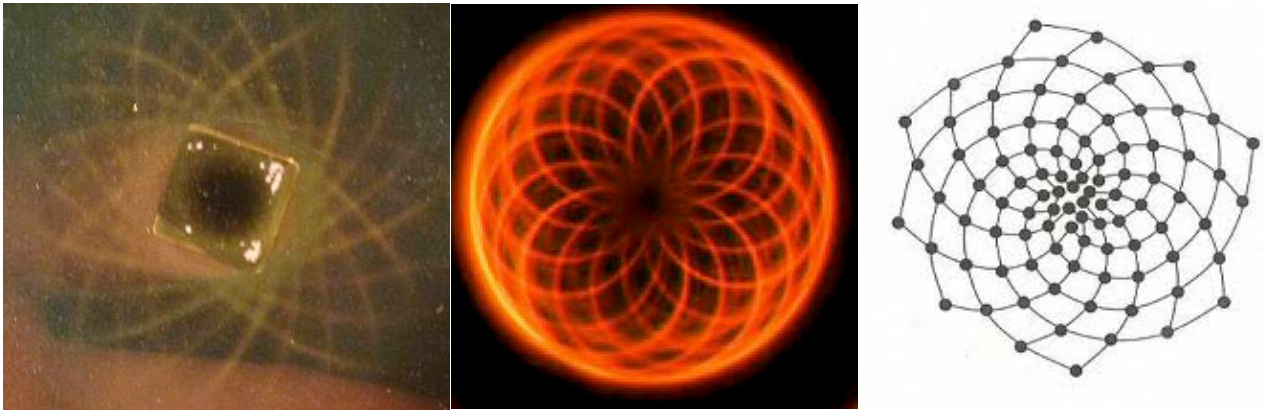

Below: Additionally, the linear divergence required from the center before making the circle has a radius always of Φ^{-3} . The centrifugal field which is drawn out is the **MEAN DIVERGENT FIELD** of centrifugal magnetism, obviously and logically so the field extends both further and shorter than this, but this formula calculates the mean field of the predominance of centrifugal divergence. Copyright discovery 7-28-2014 Ken L. Wheeler

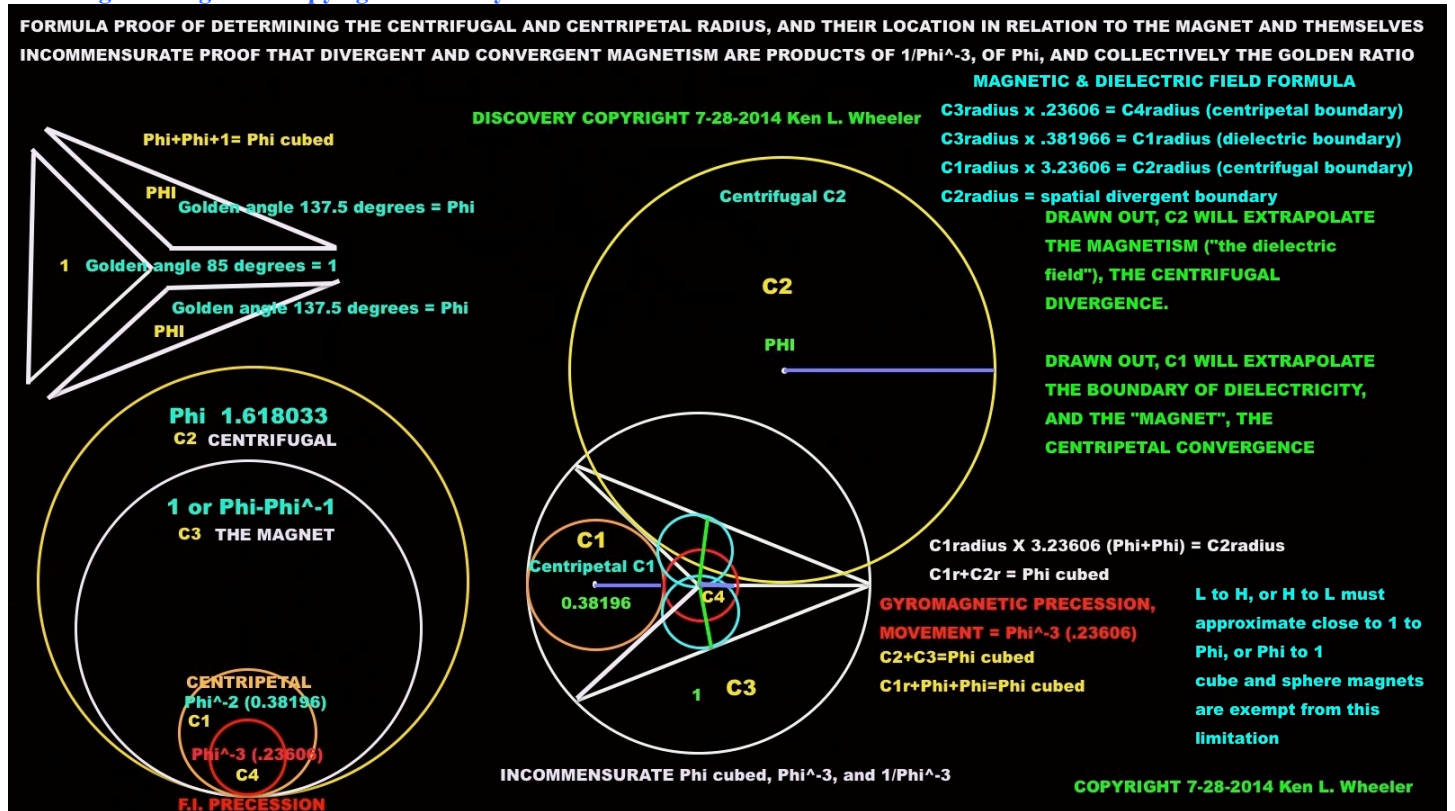

Below: Using my discovered formula, the magnetic hypotrochoid polarized hyperboloid can be extrapolated in simplex.

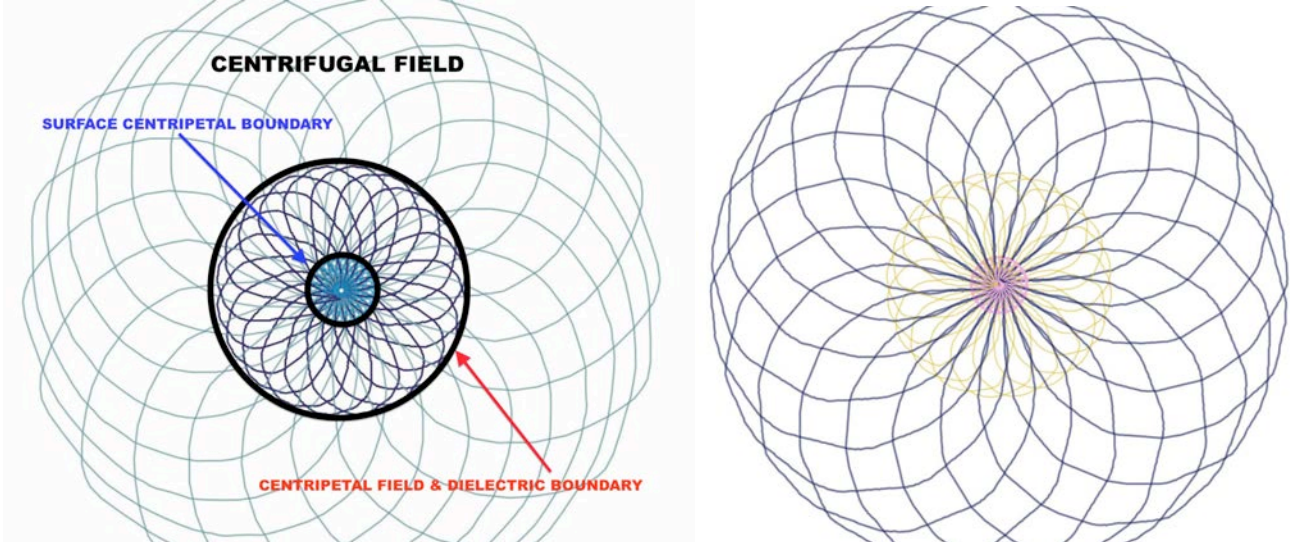

Below: Field divergence and convergence in creation in simplex will demonstrate the spherical magneto-dielectric hyperboloid of the conjugate field dynamics as created and found in the 'magnet'.

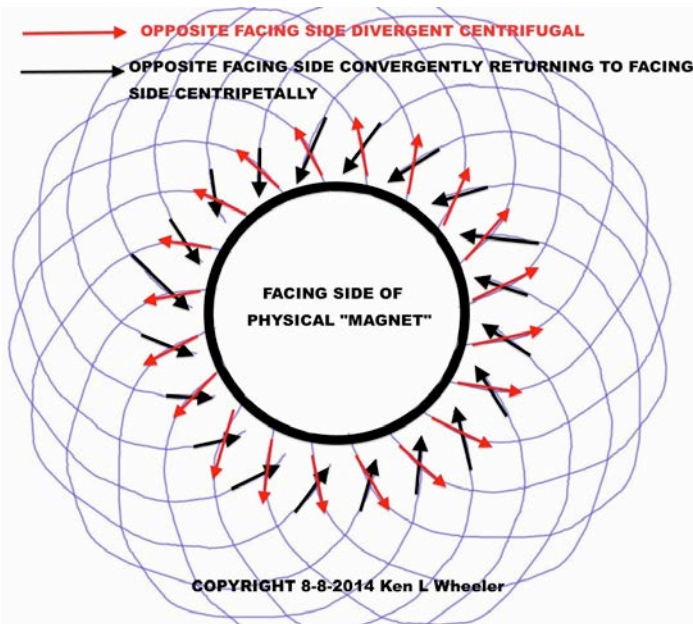

DRAWN CENTRIPETAL BOUNDARY (MAROON)
 DRAWN PHYSICAL "MAGNET" BOUNDARY AND CENTRIPETAL CONVERGENCE (LIGHT BLUE)
 DRAWING (BROWN) CENTRIFUGAL DIVERGENCE

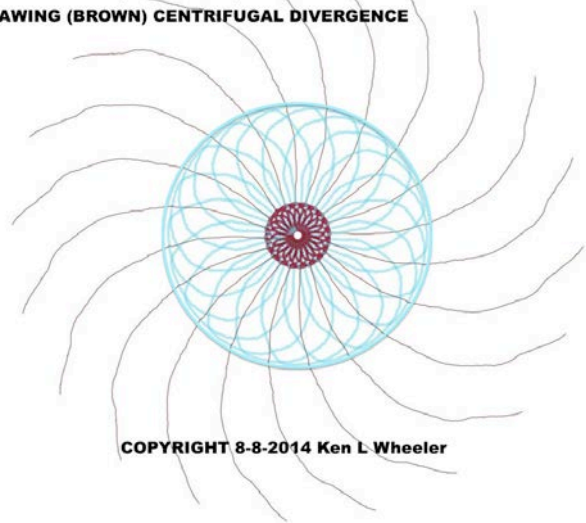

Below: Further empirical demonstration of field pressure mediation as necessitated by the gyromagnetic ratio and the golden section of how magnetic divergences, and convergences of dielectricity in discharge mediates its pressures polarizations and magnetic reciprocations along and against converging magnetic centripetal pressures.

DRAWN CENTRIFUGAL BOUNDARY OF MEAN DIVERGENCE (GREEN)
 DRAWN CENTRIPETAL CONVERGENCE AND PHYSICAL MAGNET BOUNDARY (MAROON)
 DRAWN CENTRIPETAL SURFACE FACING BOUNDARY (BLUE)

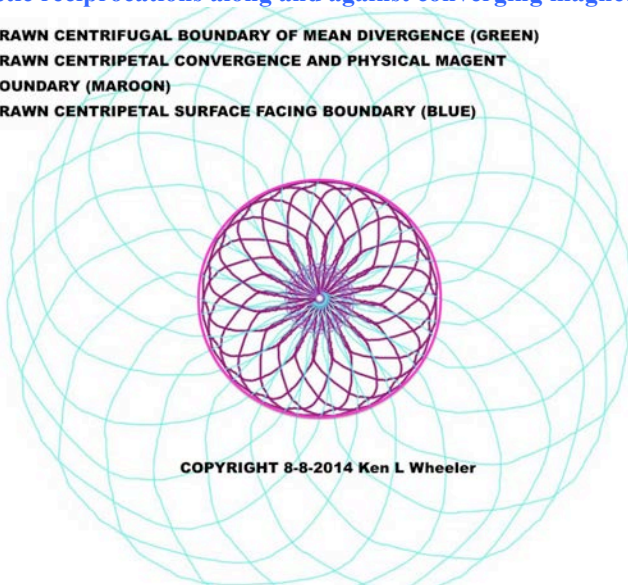

SURFACE CENTRIPETAL BOUNDARY (MAROON)
 PHYSICAL MAGNET AND CENTRIPETAL CONVERGENCE (BLUE)



Below: A clear explanation of yet another attribute of point non-specific field incommensurability.

**IS THE GREEN THE CENTRIPETAL SURFACE BOUNDARY, OR CENTRIPETAL CONVERGENCE ZONE AND PHYSICAL MAGNET AND BLUE CENTRIFUGAL OPPOSITE SIDE DIVERGENCE AND FACING SIDE CONVERGENCE?
OR...IS THE BLUE THE CENTRIPETAL CONVERGENCE ZONE AND THE GREEN THE GREEN THE CENTRIPETAL SURFACE BOUNDARY?**



COPYRIGHT 8-8-2014 Ken L Wheeler

WITHOUT THE 3RD ELEMENT OF FIELD RECIPROCATATION SHOWN, THE ANSWER IS BOTH CAN BE CORRECT. THIS IS INCOMMENSURABILITY

Below: It would take a book in itself to explain my discovery from 13 years ago and this formula finally discovered after four years of looking. Needless to say, it is the golden section mediation of divergence, convergence, and incommensurability which explains the Pythagorean discovery of the importance of incommensurability between the 137.5 golden angle, and the inertia 108-36-36 golden triangle which explains magnetic field reciprocity, growth, plant phyllotaxis, and forms the basis of the discovery of the formula above to accurately model magnetism. Discovery copyright 5-18-2014 Ken L. Wheeler

1/Phi⁻³ incommensurable geometry uniting the 137.5077-21.246-21.246 with the 108-36-36 in a circle = circumference of 1+1+1+1+1.23606 (5.23606) [1+Phi³, or 5+Phi⁻³]. Incommensurate proof of magnetic field reciprocity, divergence-convergence and natural phyllotactic growth and symmetry.
137.5077 = divergence/growth 85 = 1 108-36-36 = symmetry or Phi
85 / 360 = Phi cubed (4.23606)

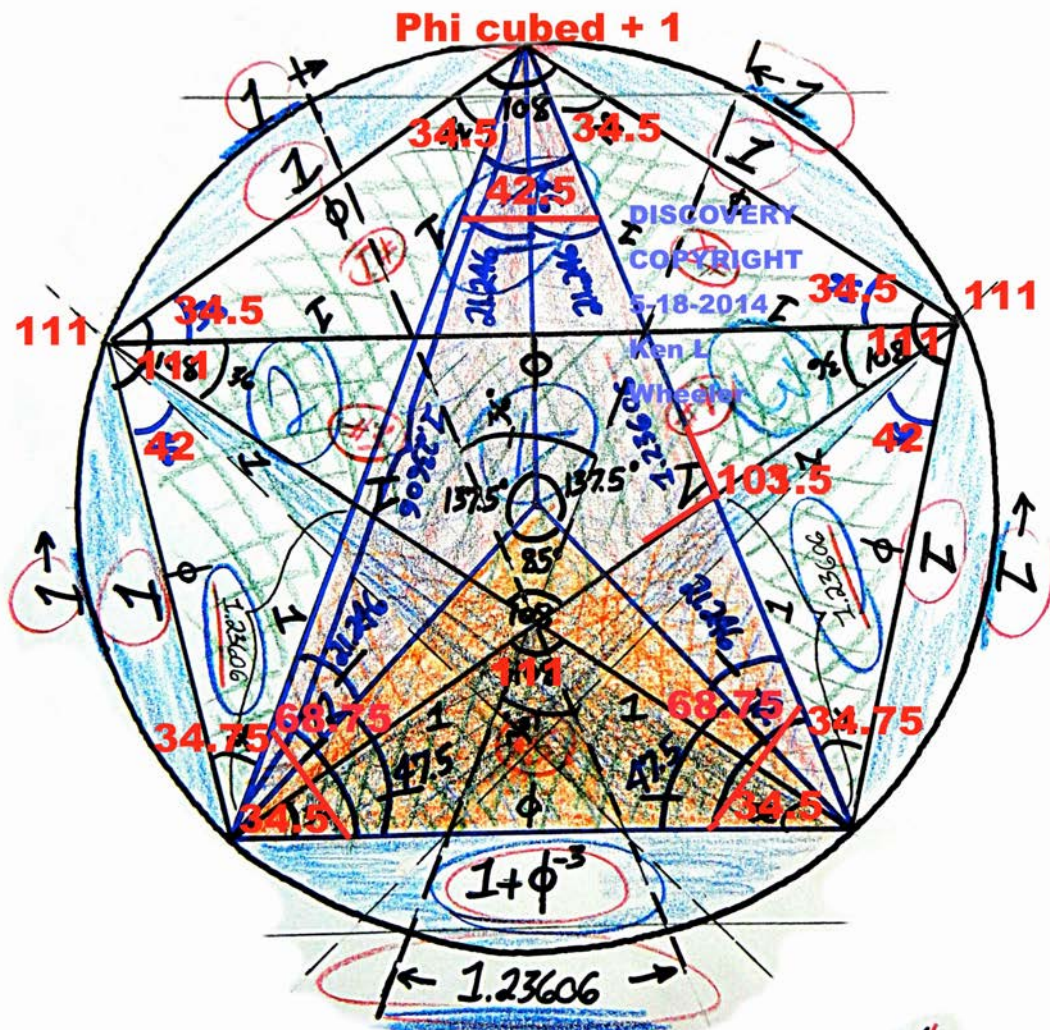

DISCOVERY COPYRIGHT 5-18-2014 Ken L. Wheeler

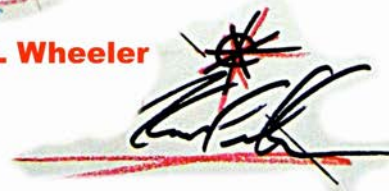

Below: Nature's own hypotrochoid spatial hyperboloid is mirrored everywhere, and as known by myself in my discovery, is likewise found in magnetic field divergent reciprocations. Empirical evidence for this discovery was later confirmed using the ferrocell and many other methods. *All movement is as against (discharge) and around a null fulcrum of dielectric inertia, the fundamental Ether and field modality in the universe.*





CRT Tube dynamics of dielectric influence from magnetic deflection and dielectric voidance

Since the CRT tube is a cathode ray dielectric projector, and knowing that magnetism deflects dielectric inertia, using a large CRT tube as an empirical model to show the field mechanics of the magnet is an obvious decision. Light cannot be directly bent or directed with electricity, only with magnetism. Electricity is $\Phi \times \Psi$ (dielectric and magnetic). Dielectricity in the Z-axis radial dielectric component of light responds to deflection only from magnetism, or the magnetic component of electricity; the magnetic constituent of electricity can direct it to a degree. *Six Fundamental Types of Waves: First set: TEM (transverse electro magnetic) Waves: 1. TE – Transverse electric (dielectric) 2. TM – Transverse magnetic 3. TEM – Transverse dielectro-electromagnetic with dielectric as the longitudinal coaxial Z-axis. Second set: Longitudinal waves: 1. LD - Longitudinal dielectric 2. LM - Longitudinal magneto 3. LMD - Longitudinal magneto dielectric.* Take special note below of the inverse field vortex along either pole, and the likewise inverse spin at the centripetal convergent zones.

Below: Left, testing patters on wall filmed from camcorder and fed to the CRT tube for magnetic testing. Right photo showing conjugate field patterns on CRT from dielectric deflection of the 2” by 1” neodymium magnet.

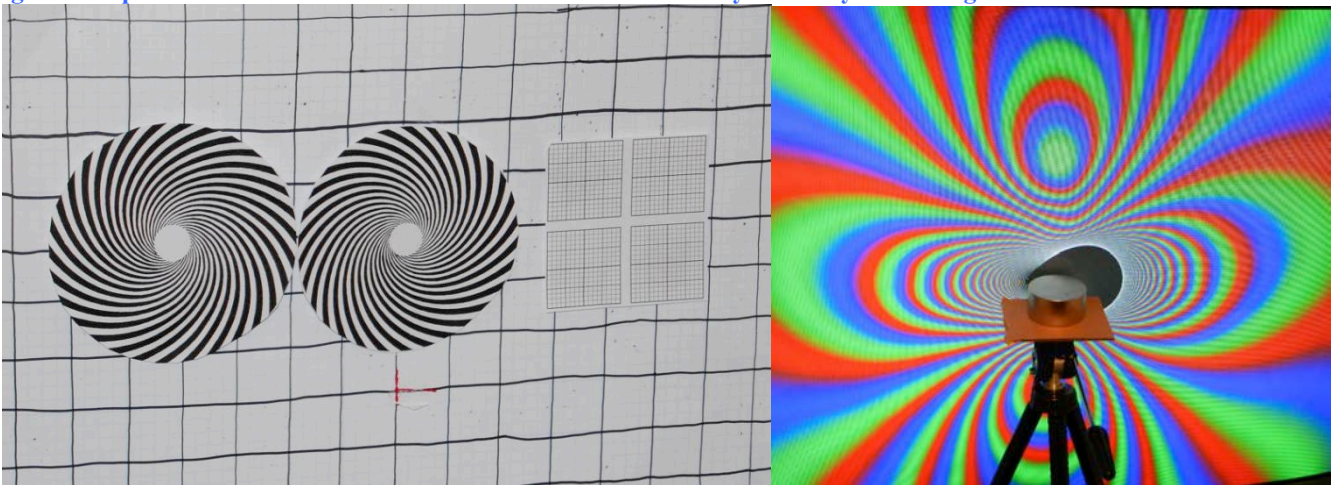

Below: Showing the centrifugal divergent magnetism, the centripetal, and the dielectric inertial plane. On right, 1" cube magnet showing concentration of toroidal attraction of dielectric to dielectric and the blue bowl shaped patterns of divergent centrifugal magnetism and in the center above and below are the green centripetal magnetism dominances.

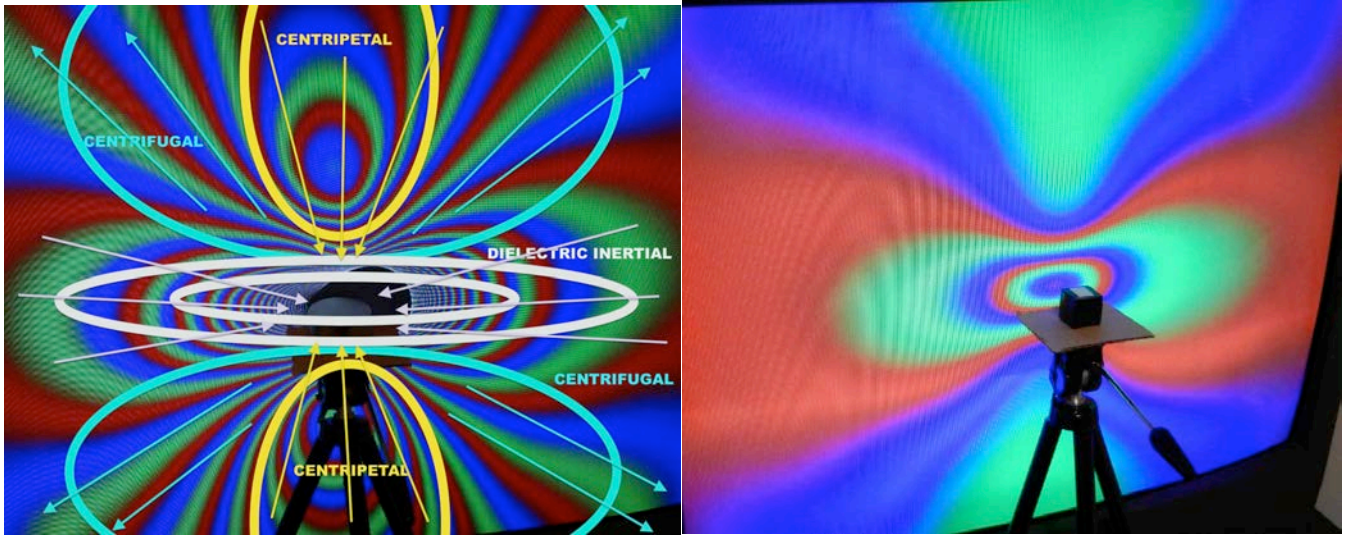

Below: Both images below are the exact same clockwise spiral from the testing pattern on the wall, but the left shows a torus formation proving the centrifugal magnetism on this side of the magnet is CCW, and exactly inverse on the image on the right, in which the CW projected spiral maintains its directionality, proving that this inverse pole of the magnet is moving in the same direction as the projected vortex, which is clockwise.

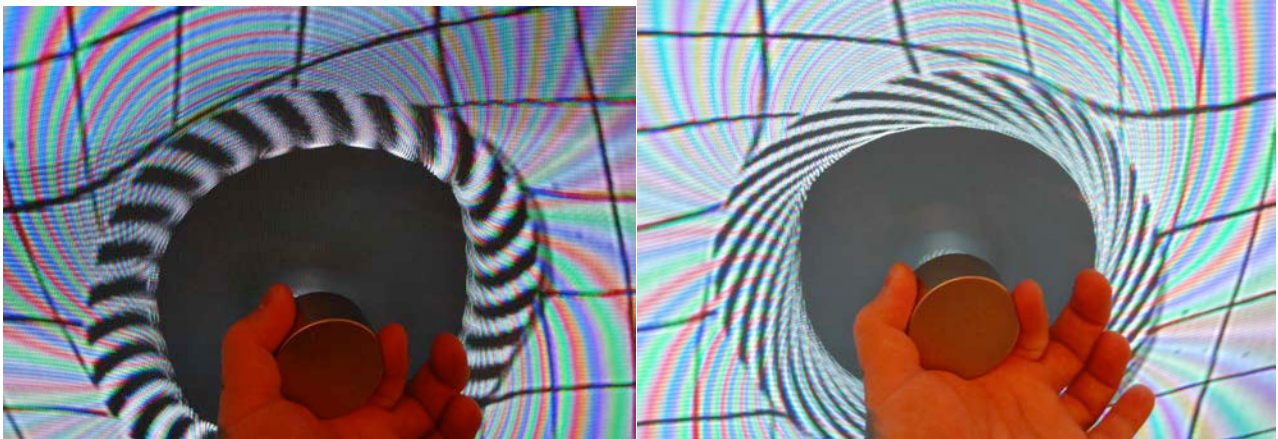

Below: A pair of perfect examples of both inverse pole CW and CCW spin, inverse at both centripetal and centrifugal as must be necessitated! On the left you can see the spiral projected ring has been made to form a torus meaning the centrifugal magnetism is inverse to the projected clockwise spiral, making the centrifugal magnetism CCW, in which case, as is demonstrated you can see at the center a CW centripetal formation. Exactly the opposite on the right, the centrifugal magnetism is going in the SAME direction as the CW projected vortex on the CRT, and as must be the case at the center, the centripetal magnetic convergence is going CCW.

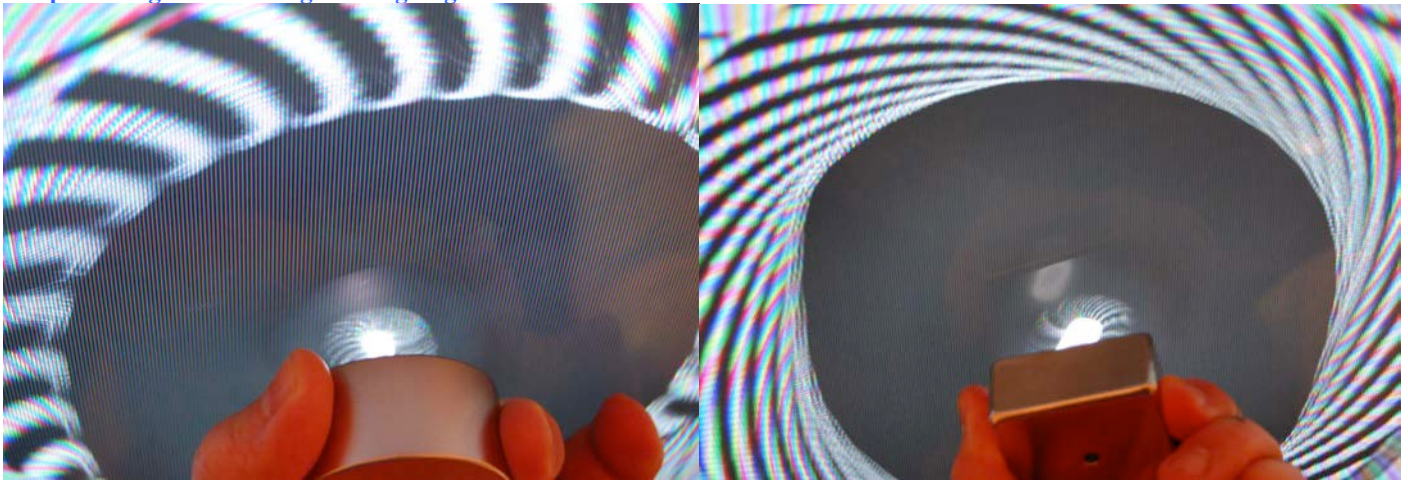

Below: On the left you can see the pair of hyperbolas as being pushed out by the centrifugal magnetism and likewise tighter compression of dielectric inertial plane convergence from the CRT forming a shrinking sphere at the center as attracted to the dielectric inertial plane of the magnet very close to the CRT tube. On the right you can see field pressure mediation very close to the CRT tube at which there is an egg shaped formation. Along the dielectric inertial plane the perfect pressure mediation is a dielectric voidance and a centrifugal magnetic displacement. Likewise you can see along the centripetal point a higher concentration of light. This type of conjugate field pressure mediation is no different than squeezing a circular balloon on one end at which the point of counterspatial constriction is small and the spatial divergence is expanded.

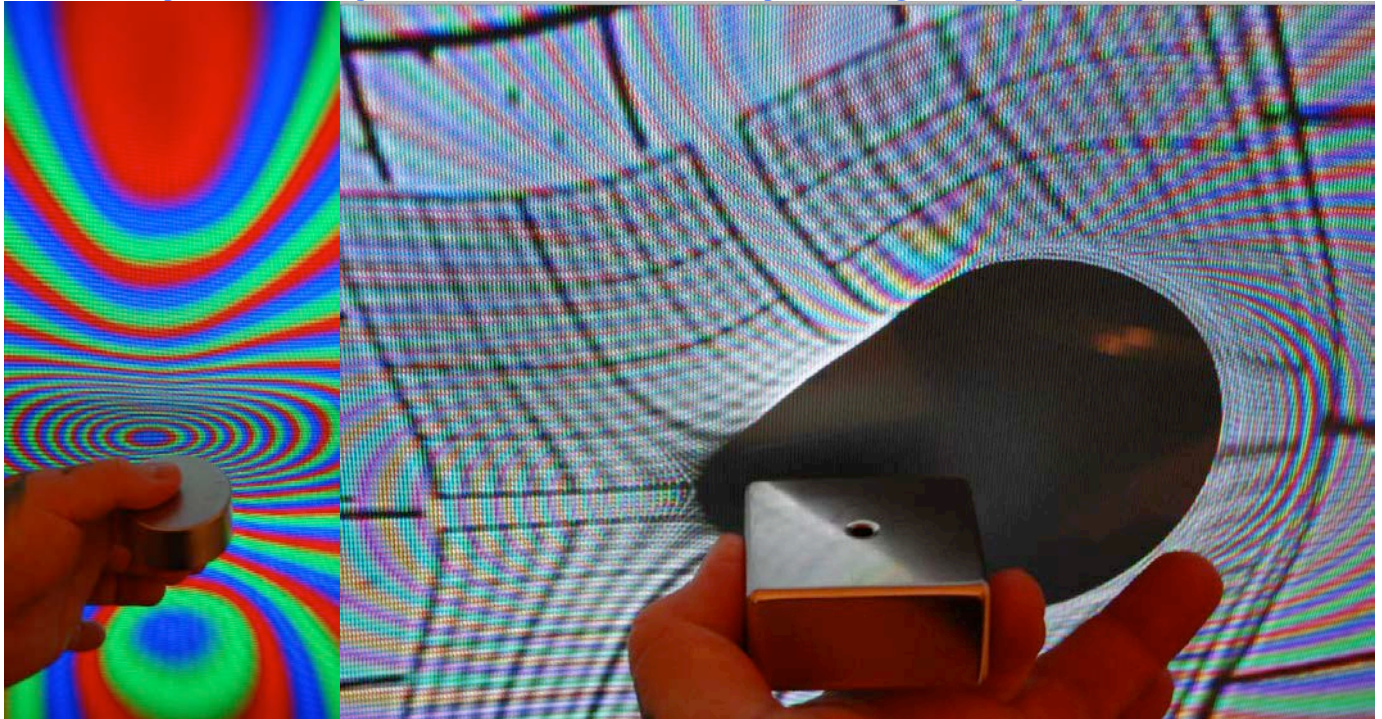

Below: On left, we have the grid being twisted clockwise, on the right we have the projected grid, a dielectric projection of electrostatics being twisted counterclockwise on the inverse pole of the magnet.

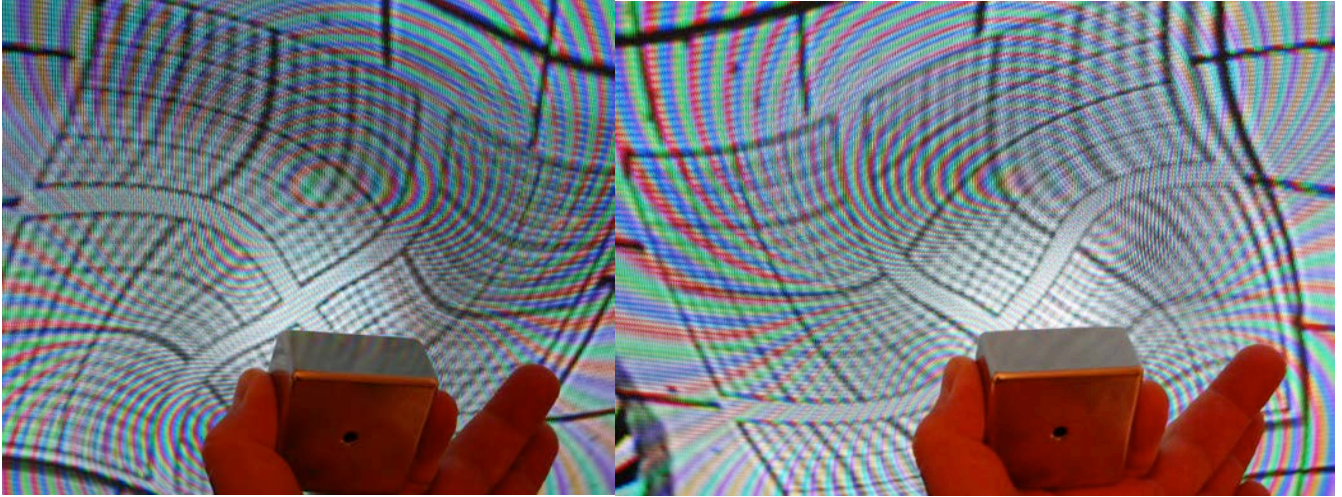

Below: As can be seen below, instead of using the vortex projected, I used the square grid in which you can see likewise CW and CCW dielectric vortex displacement as displayed inverse to the divergent magnetic field displacements as placed near the CRT. Additionally as always and must be the case, the centripetal bright spot at the center is the dielectric convergent point of centripetal voidance between both the magnets dielectric inertial plane and the projected dielectric from the CRT. Notice inverse centripetal movement respective to the centrifugal.

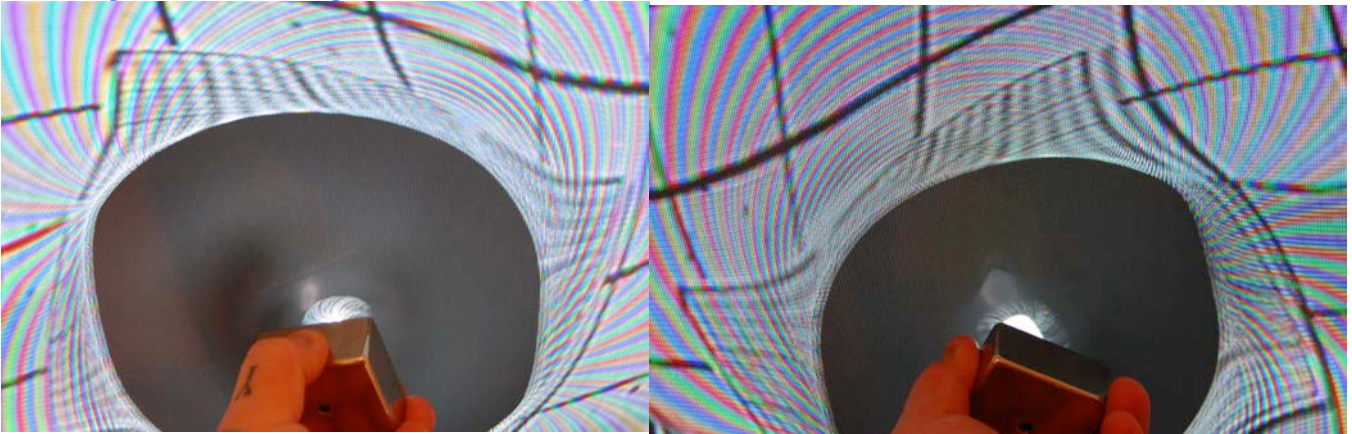

Below: Alternating rings of cloudy light and dark as necessitated by dielectric displacement from the centrifugal magnetism as against the CRT.

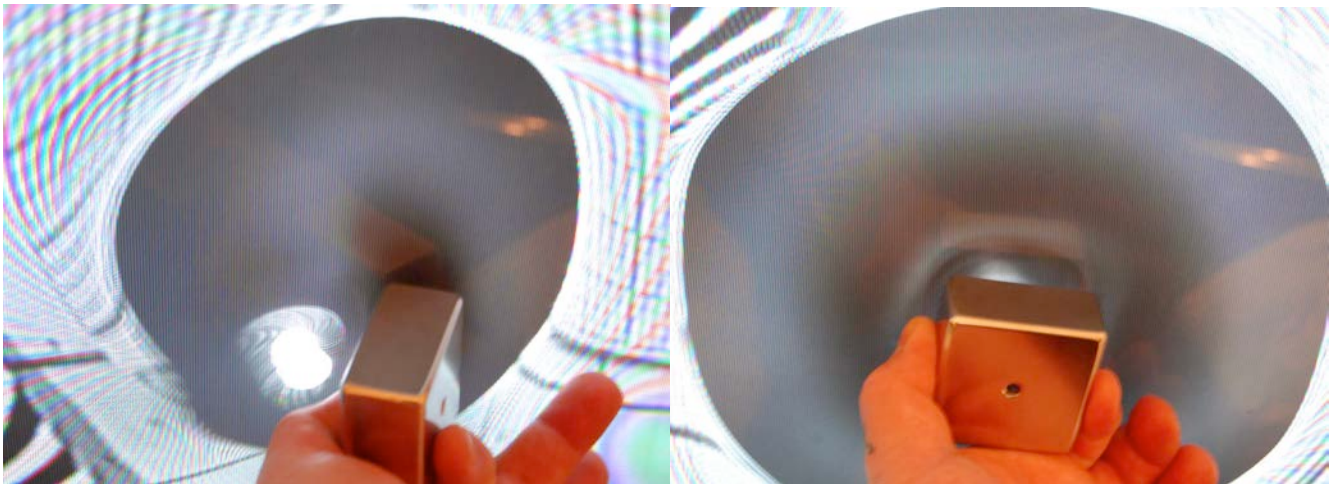

Below: Showing vertical orientation of the magnet relative to the CRT screen in which, as has been incorrectly described by others in the past as showing “four poles of a magnet”, it shows in fact no such nonsense. What is seen are the centripetal points, two at either pole, and both top and bottom (as that magnet is orientated vertically) along the dielectric inertial plane of the magnet. All four ‘loops’ at the corners are logically so the centrifugal magnetism displacing the dielectric field from the CRT tube.

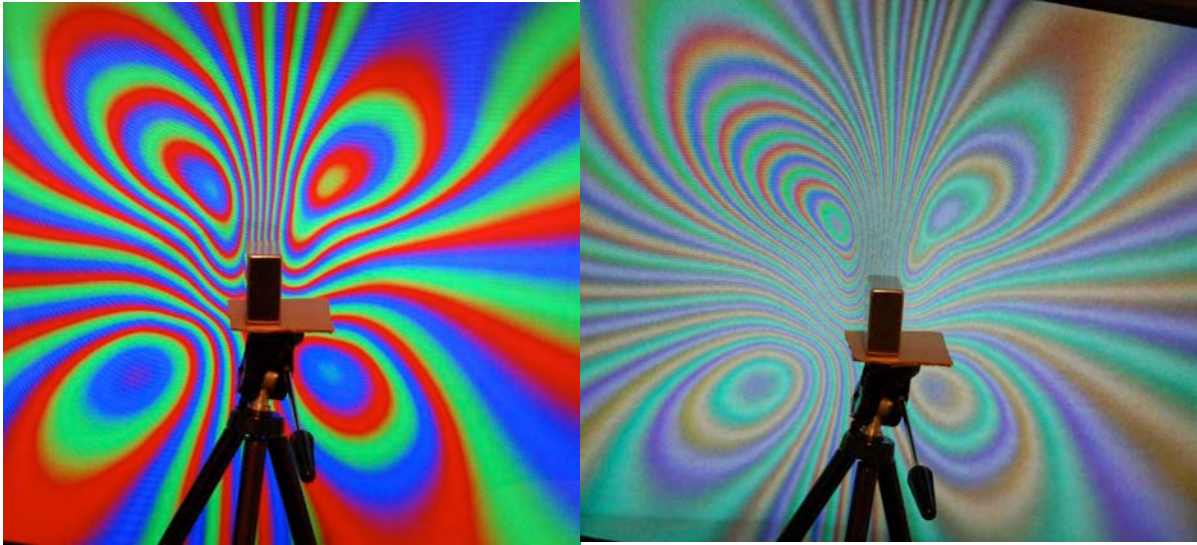

Below: Very close proximity complete dielectric displacement from the centrifugal magnetism. On left from the centrifugal magnetism face-on. On the right from the centrifugal magnetism edge on showing the four corners, or ‘loops’ of displacement at the bottom edge center of the dielectric inertial plane touching the CRT, which has the closest convergence of dielectric to dielectric.

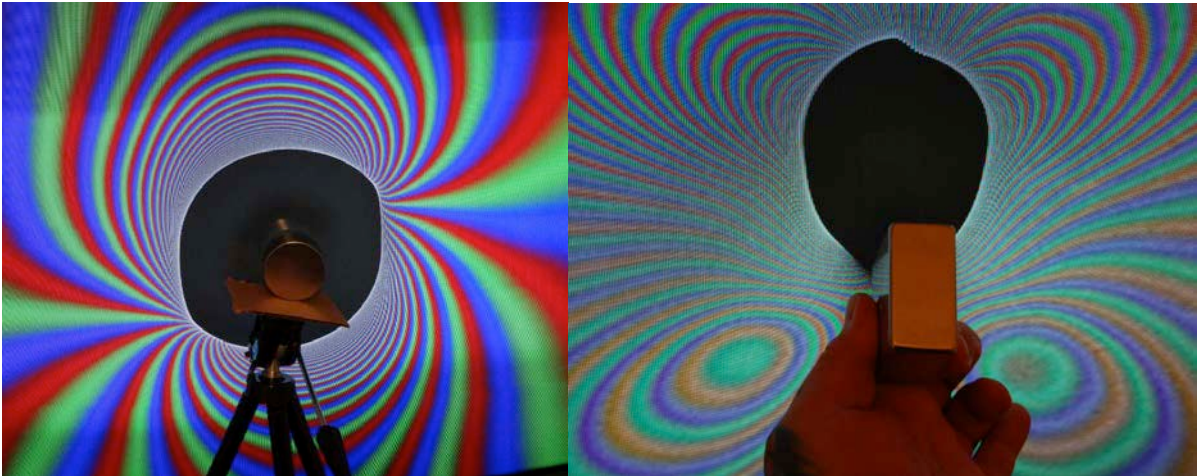

Below: Showing the field pressure mediations of centrifugal magnetism, centripetal and the dielectric inertial plane, both left and right pictures.

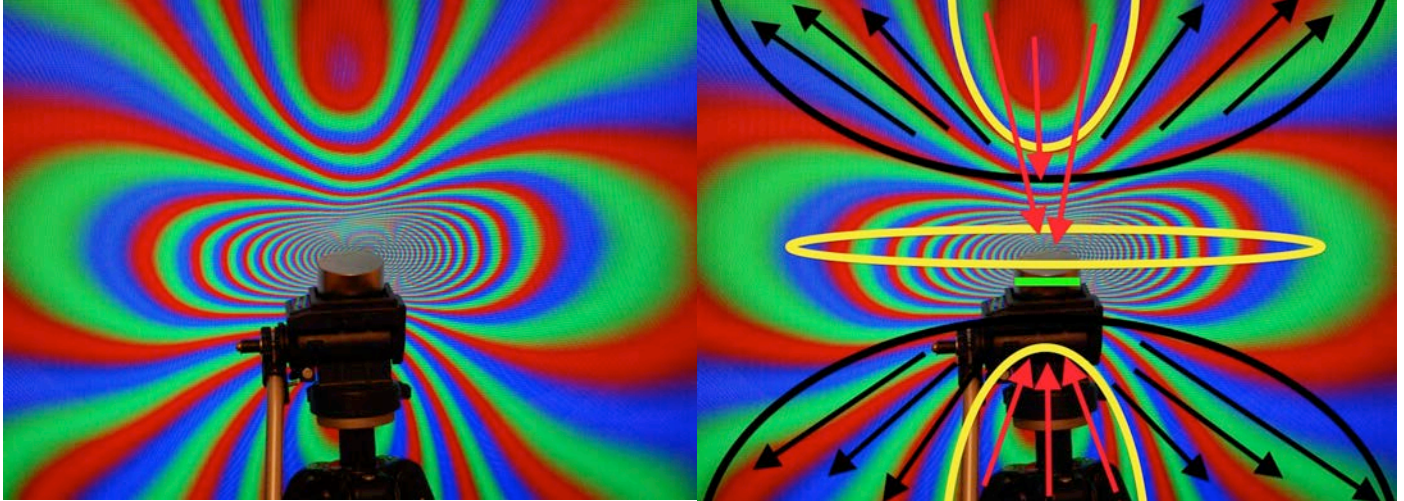

Below: Showing vertical orientation of the magnet relative to the CRT screen, and on the right the four loops of either sides four edges of centrifugal magnetism marked by black arrows. Likewise showing the centripetal entry points in this orientation marked by the red arrows.

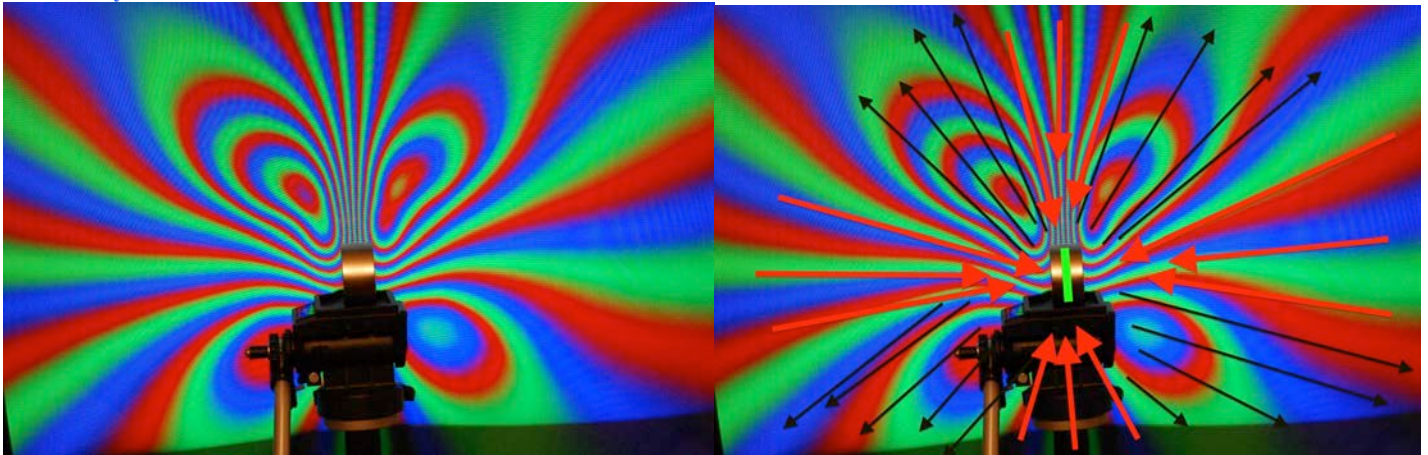

The Ferrocell demonstrations of magnetic hyperboloids and magneto-dielectric divergence and convergence

Inventor Timm A. Vanderelli ferrocell: The magnetic flux viewer utilizes the combined properties of a ferromagnetic colloidal mixture, magnetism and the transmission of light to view a presentation of magnetic flux. The magnetic flux viewer comprises a ferromagnetic colloidal mixture positioned between two optically transmissive lenses, the lenses including a means for containing the mixture there between. Mixture is comprised of a plurality of magnetically reactive particles. There is at least one magnetic source juxtaposed about the mixture and a visible light source that is positioned to project through the mixture. The interaction of light waves and the mixture creates a visual presentation of magnetic flux.

The ferromagnetic colloidal mixture comprises nano-sized magnetite particles coated with a surfactant and suspended in a colloidal mixture that respond to the application of a localized magnetic field thereby aligning themselves in the direction of the magnetic field and forming nano-particle chains. Preferably, the ferromagnetic colloidal mixture is a translucent fluid. When this translucent mixture is contained and placed into a magnetic field, light waves scatter and rotate as they pass through the mixture positioned between the two lenses in regions where the magnetic field has reached its lowest potential. In examples, the viewer also creates a visual presentation of the interaction between magnetic flux and other elements of matter. The claimed magnetic flux viewer makes this Super-paramagnetic event visible. - *Timm A. Vanderelli (www.ferrocell.us)*

The Ferrocell is a simple, low-cost device that will scatter light in a direction determined by the application of a magnetic field (magnetic anisotropy). Polarized *or* un-polarized light will reveal a representation of the applied field with a 3-D spatial geometry in agreement with Maxwell's Equations. Utilizing quantum effects made possible by nanotechnology, this Ferrohydrodynamic Lens has the potential to enhance the performance of many existing Photonic applications.

Apply light and magnetism to either surface. The strength and orientation of the applied field will determine the plane (angle) of light coming out of the cell. Using a permanent magnet is the simplest way to apply a field and see how a Ferrocell will change the path of light. To make this event visible to the naked eye, a large surface area and strong magnetic fields are required. Currently, there are no demonstration units available for smaller scales. Although similar to the Faraday Effect, a Ferrocell affects light up to 90 degrees in a single stage, whereas a Faraday rotator would require two stages to accomplish the same task.. And a Ferrocell will exhibit the same results with polarized or non-polarized light. Using four stages of deflection with a Ferrocell will allow 360 degrees of rotation. - *Timm A. Vanderelli* (www.ferrocell.us)

My deepest and warm thanks go out to Timm Vanderelli of Ferrocell U.S.A. in material support & providing more empirical proof for the worlds first accurate explanation of how a magnet works, as illuminated in this work. Magneto-dielectric field incommensurability (F.I.) can now not only be defined in full but also illustrated in depth by use of the T. Vanderelli Ferrocell invention (US8246356, US20070241745). All my accurate conclusions of magneto-dielectric conjugate field incommensurability now have further empirical validity thanks to the ferrocell; after the fact of my discovery, and my disclosure of the magneto-dielectric field mechanics as to how a 'magnet' operates, its field inertia and discharge hyperboloid formation, I learned of the ferrocell invention. After the 2nd edition, I came across the ferrocell, one of the key empirical validities I needed to prove my theory accurate.

Every institute of learning, even down to high school and lower, should own a ferrocell to educate, inspire, and enlighten future minds as to the fundamental forces of nature hidden within light and especially magnetism; which are governed by dielectric inertia both in whole and in part. The old method of demonstrating magnetism via iron filings is both horrible and an error since the iron dust undergoes magnetic induction. The only true and accurate way to see dielectricity & magnetism is with light, and the ferrocell!

Below: Deep view on left of a cube magnet, illustrated is the dielectric inertial plane in yellow and the hyperbolic bowl shaped depression of centrifugal magnetism as mediated against the opposite-side-returning centripetal magnetism. On the right is a single pole view of a cube magnet. The shape of the magnet has no bearing on the light formation along the poles being other then circular/spherical hyperboloidal convergent/divergent hypotrochoids.

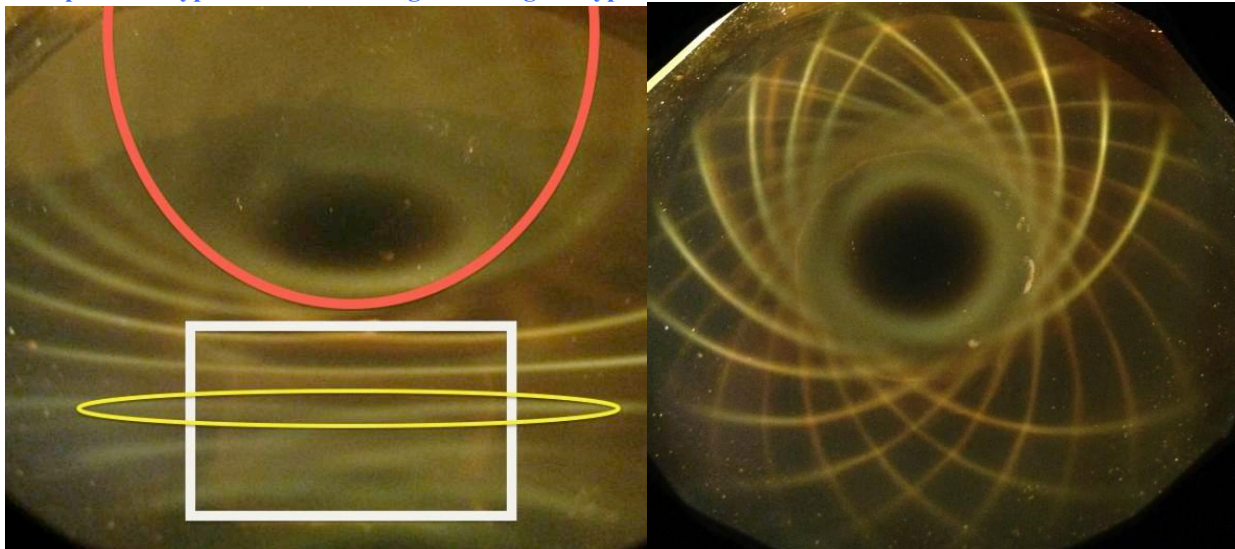

Below: Deep image views at a steep angle of a cube magnet on left, and a disk magnet on the right. Notice the centripetal 'bloom' hypotrochoid that has amazing holographic depth out of a mere micron of ferrofluid!

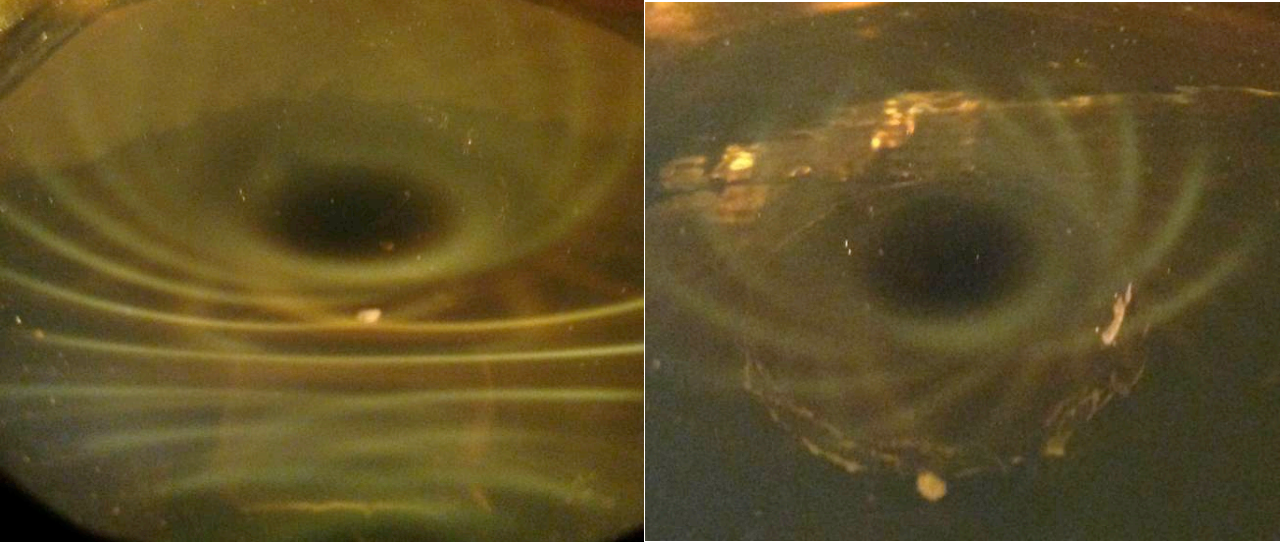

Below: Large ceramic ring magnet on left showing the pair of hypotrochoids. Notice the depth of holographic effect as seen in the sphere on the left at the center of the ring magnet. Closing dielectric voidances are necessitated to be decreasing spheres (or fixed in this case of the ring magnet) as the pressures are mediated as against magnetism and the counterspatial nature of dielectricity. On the right is a cube magnet with polarity top to bottom respectively.

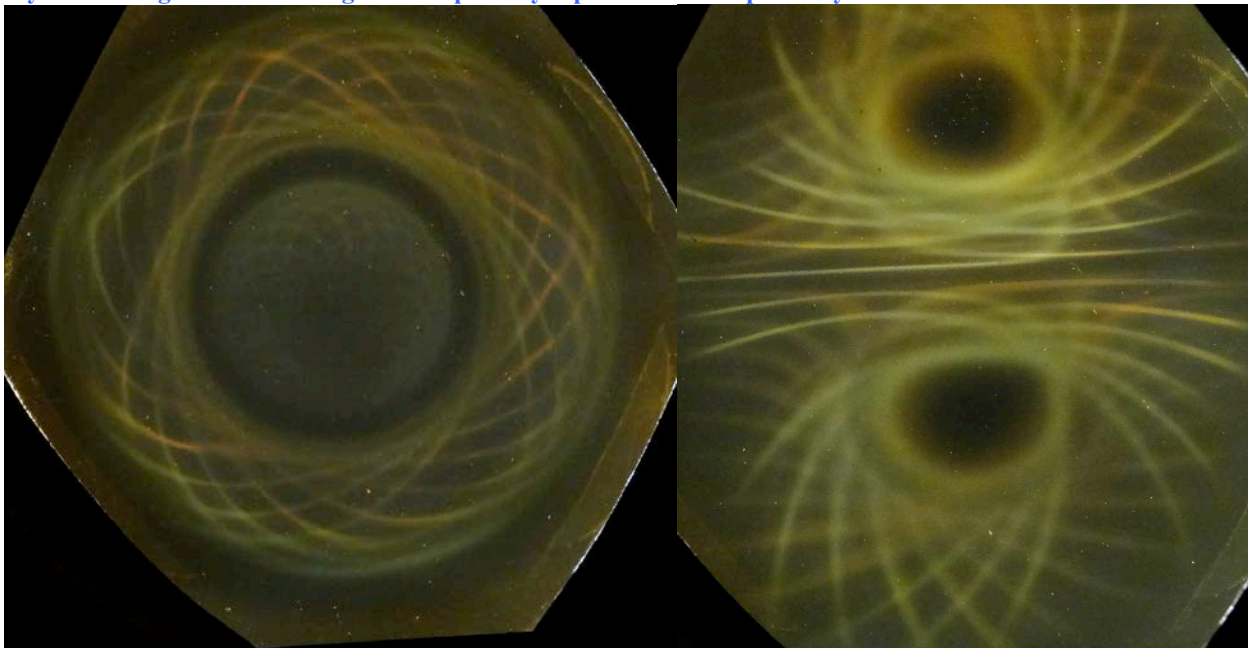

Below: Two pieces of a broken ring magnet on the left, on the right is a 1.5" ring magnet showing the pair of centripetal/centrifugal hypotrochoid patterns of light as directed by the divergent and convergent magnetism.

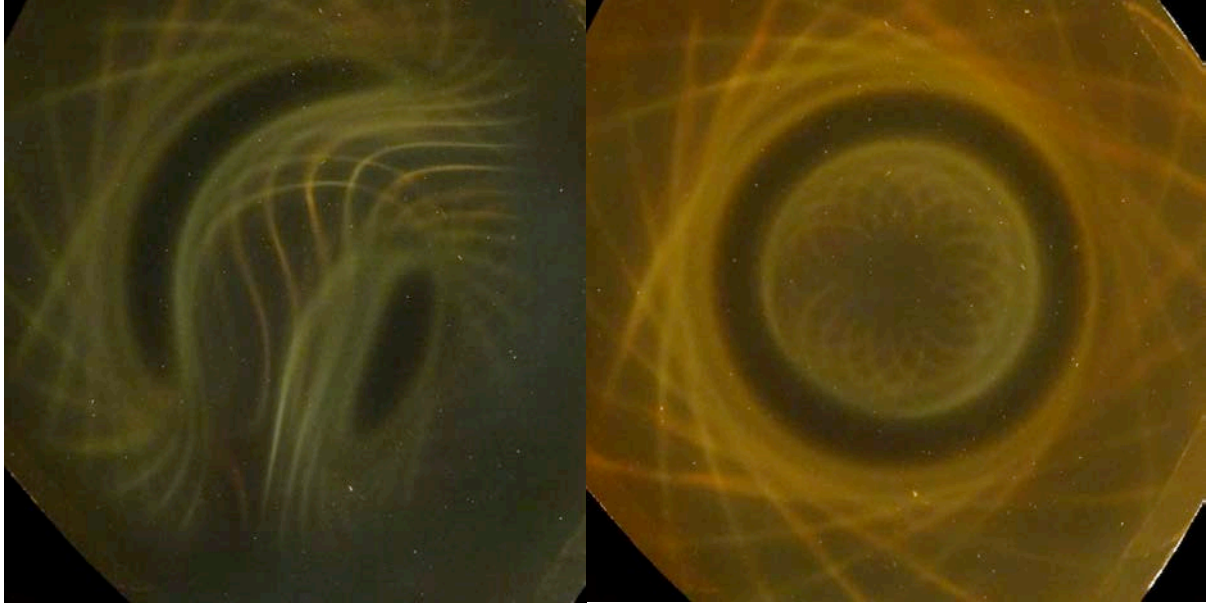

Below: Notice distorted pole on image both left and right as created by image in center of a 1/2 cylinder magnet stuck in the center of a much larger ceramic ring magnet. All field pressures mediate themselves as necessitated along the lowest pressure points of impelled divergence and convergence.

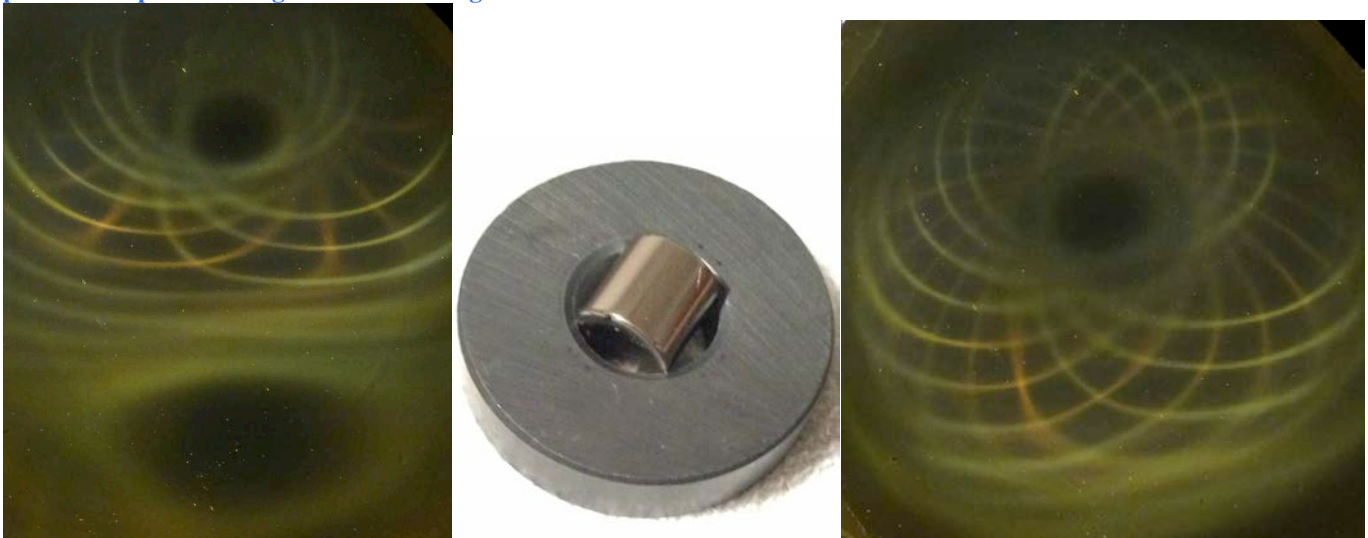

Below: Image on left, two cylinder magnets on the right connected along their non-polarized sides. Image on right broken ring magnet.

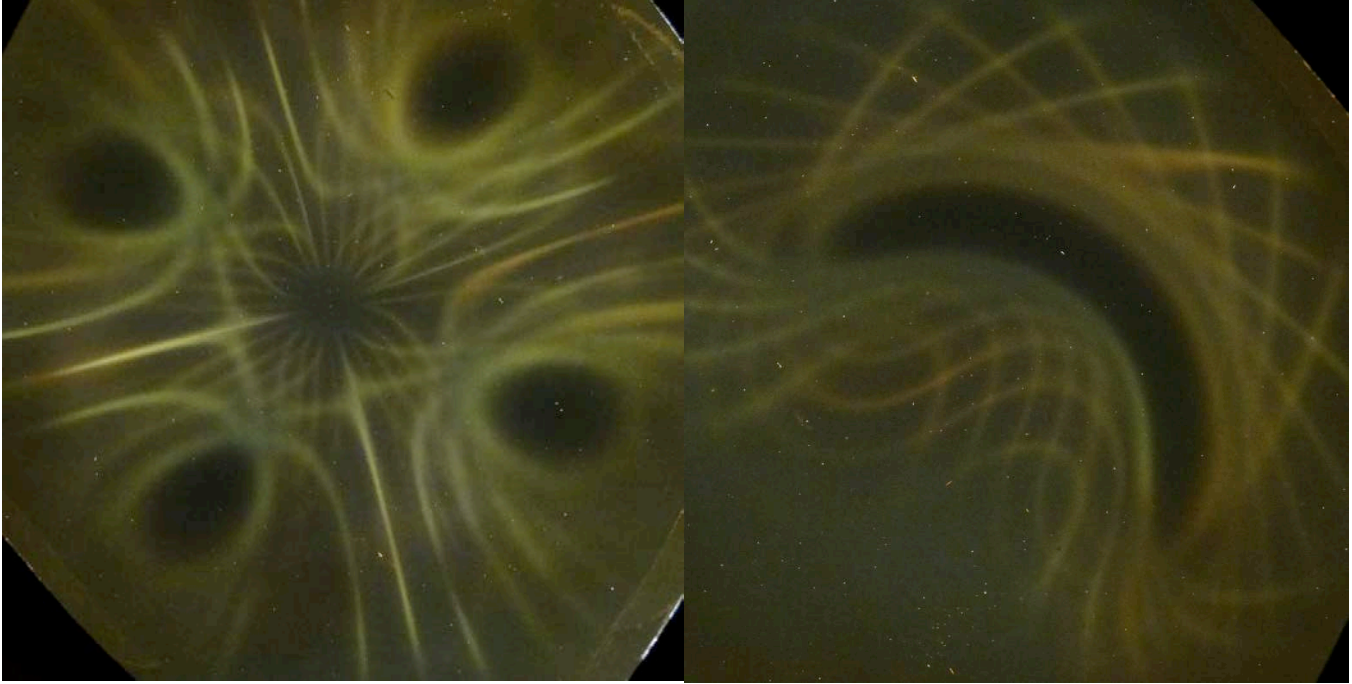

Below: 1/2" cylinder magnet along one pole on the left, and two of the same cylinder magnets on the right connected along their non-polarized sides. Notice the voidance pattern in the middle between these four poles.

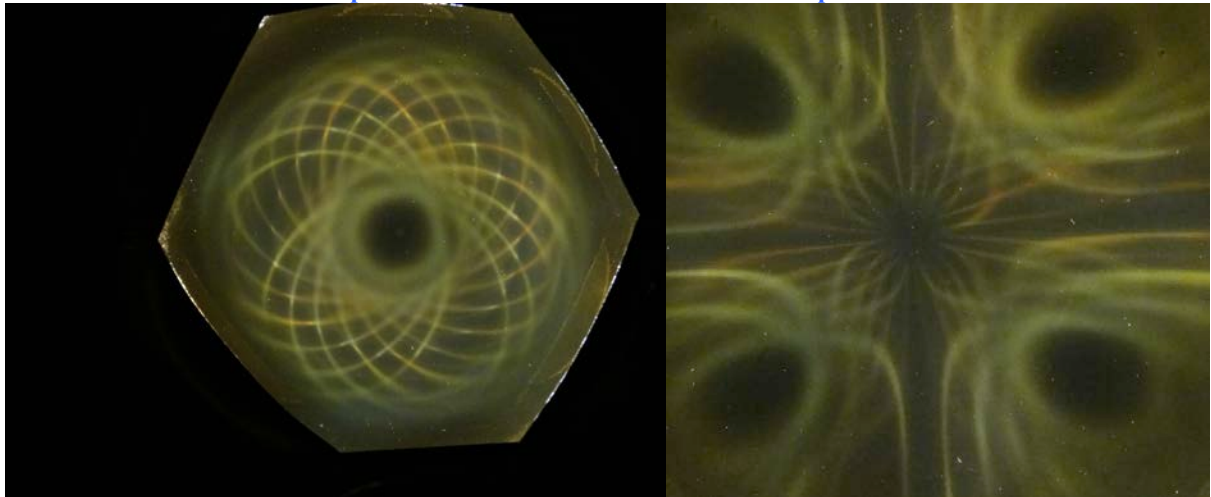

Below: Cylinder magnets. Notice image on the left where the centrifugal and centripetal 'cross' there are bright light spots at this point, this is a mid-point intersection between inverse polarity magnetic radiations at which there is a very small concentration of light as would be predicted and necessitated to exist.

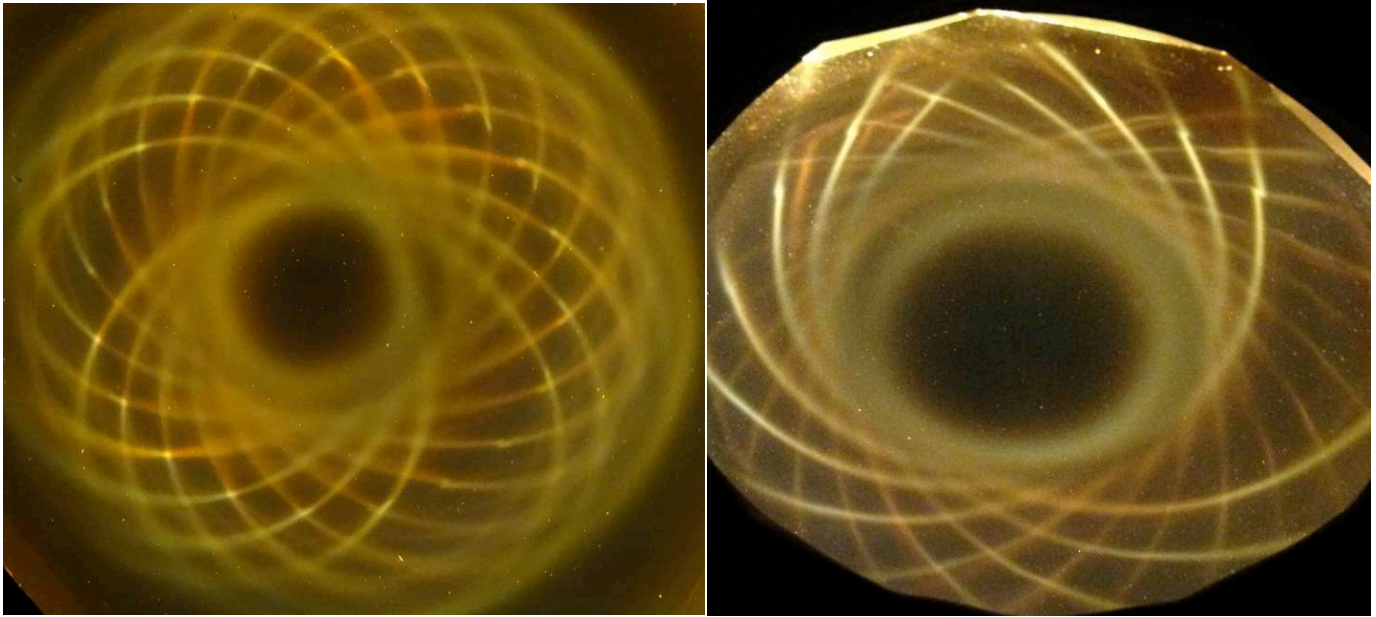

Below: Showing the holographic depth of the ferrocylinder looking at a steep angle along the pole of a cube magnet. Cube magnet, or round magnet makes no difference, field pressure is field pressure, the formations are identical field geometries. Notice on right the deep depression 'bowl shaped' formation as predicted by myself before discovering the ferrocylinder invention.

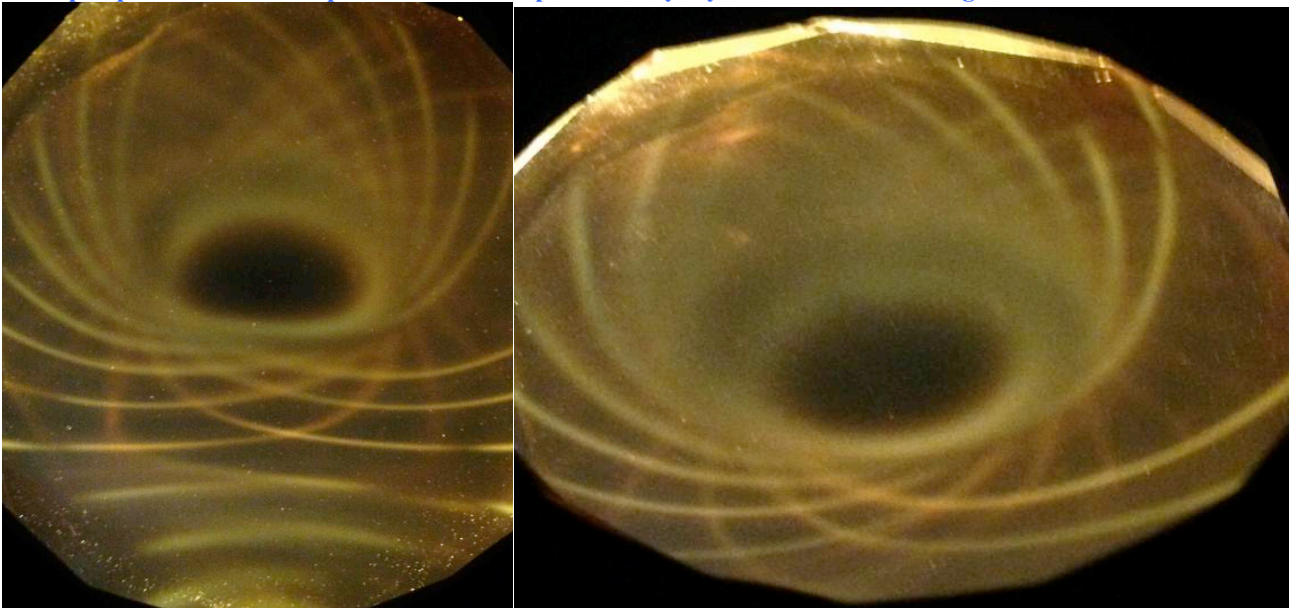

Below: Three images of cube 1" magnets under the ferrocell. Notice the bright white light along the inertial plane on the images, especially on the far right.

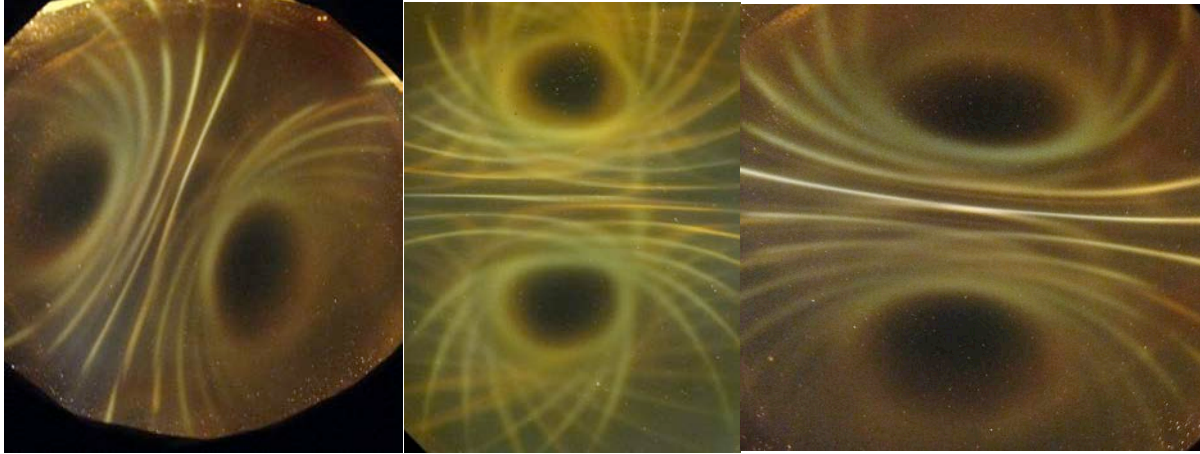

Below: A pair of my predicted discoveries of golden ratio incommensurability which must exist within the magneto-dielectric system of the 'magnet'. Discoveries copyright 7-12-2014 Ken L. Wheeler.

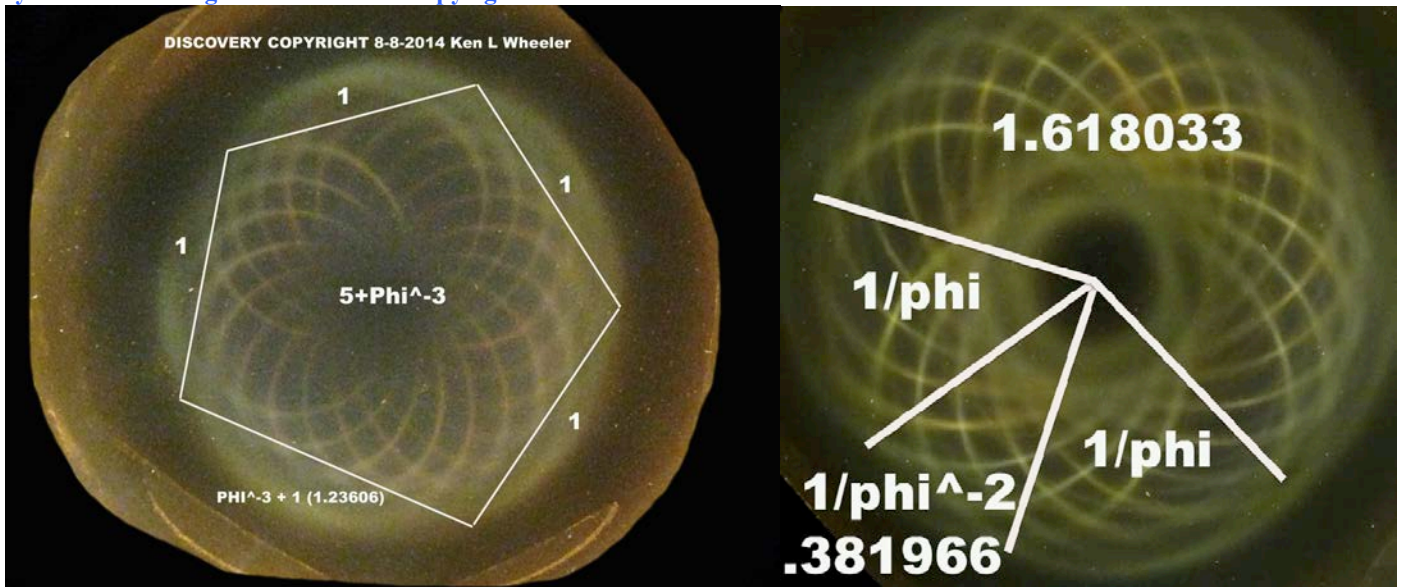

Below: Broken ring magnets. On left showing one larger piece. Middle picture showing larger piece with smaller broken piece. Likewise image on right.

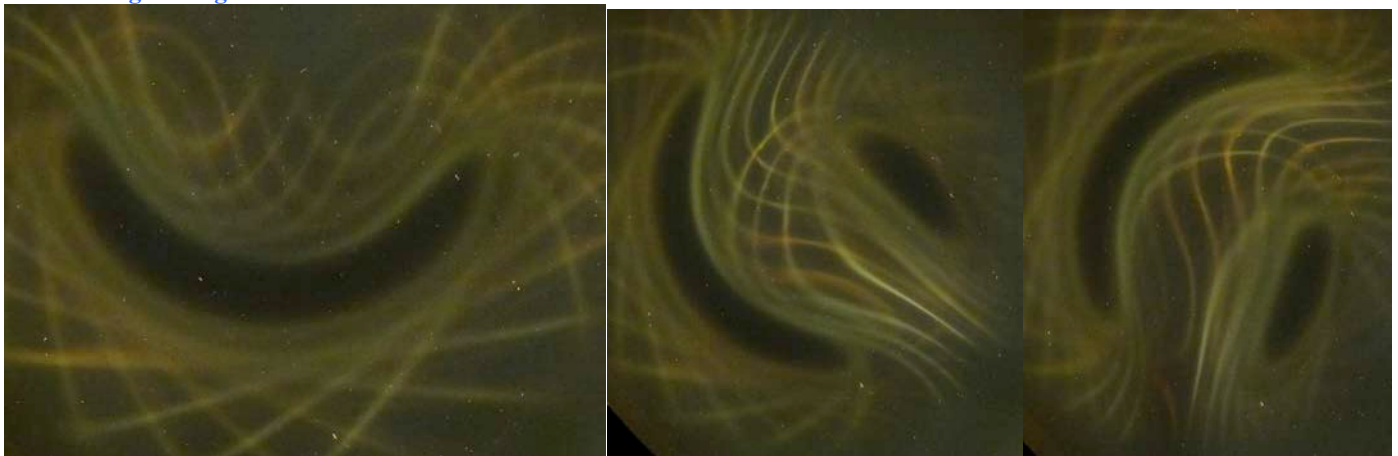

Below: Large ceramic magnet with neodymium magnet attached. On right showing both together under the ferrocell. With field pressures equalized both magnets appear no different than a single ring magnet.

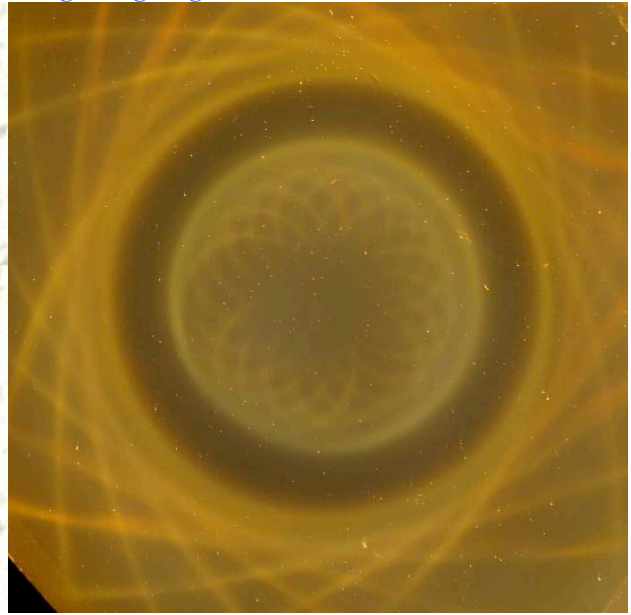

Below: Two color inverted images of ring magnets under the ferrocell. Notice the perfect pair of inner and outer hypotrochoid of convergence and divergence.

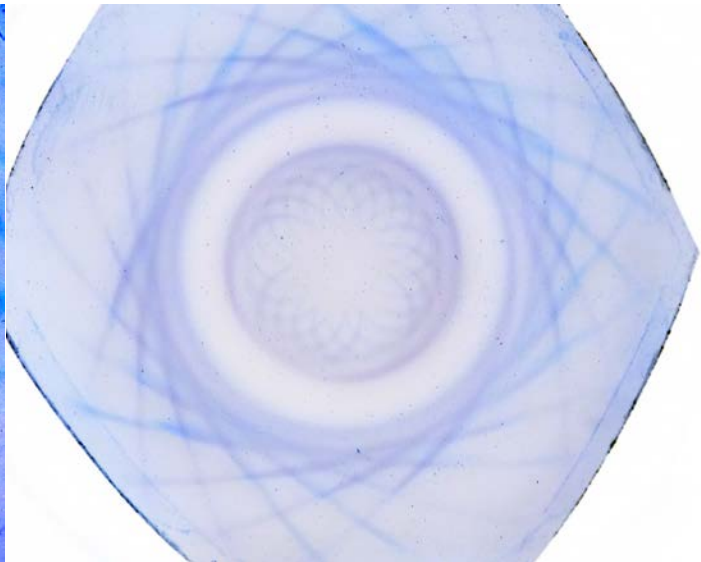
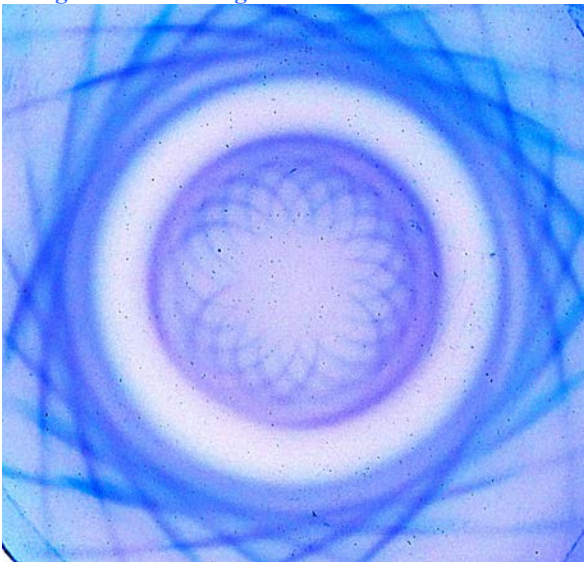

Below: Cube magnet under ferrocell. Polarity is left to right on left image, and top to bottom on right image. Notice the brighter yellow light along the inertial plane of the magnet.

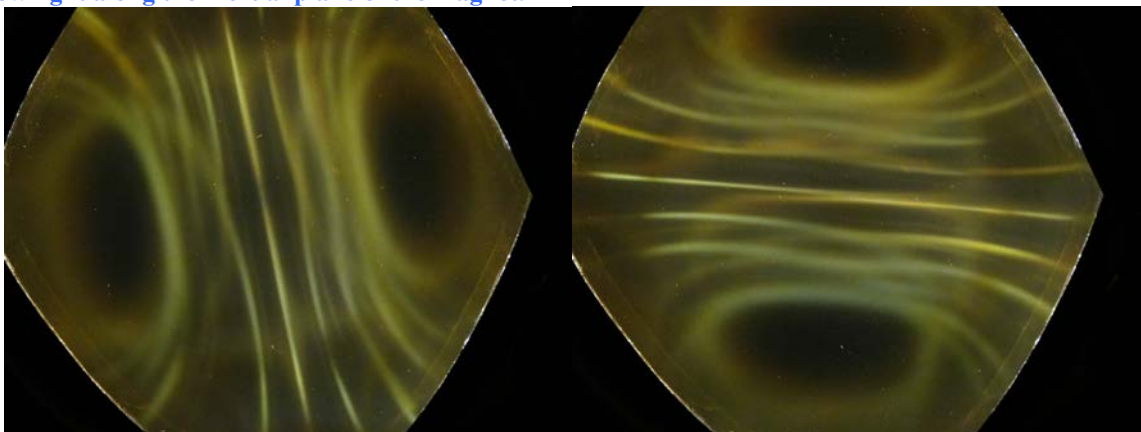

Below: Cube magnet under ferrocell. Image on left has been inverted. Showing polarity top and bottom. Notice the radial compression and voidance of the light along the dielectric inertial planes of the magnet.

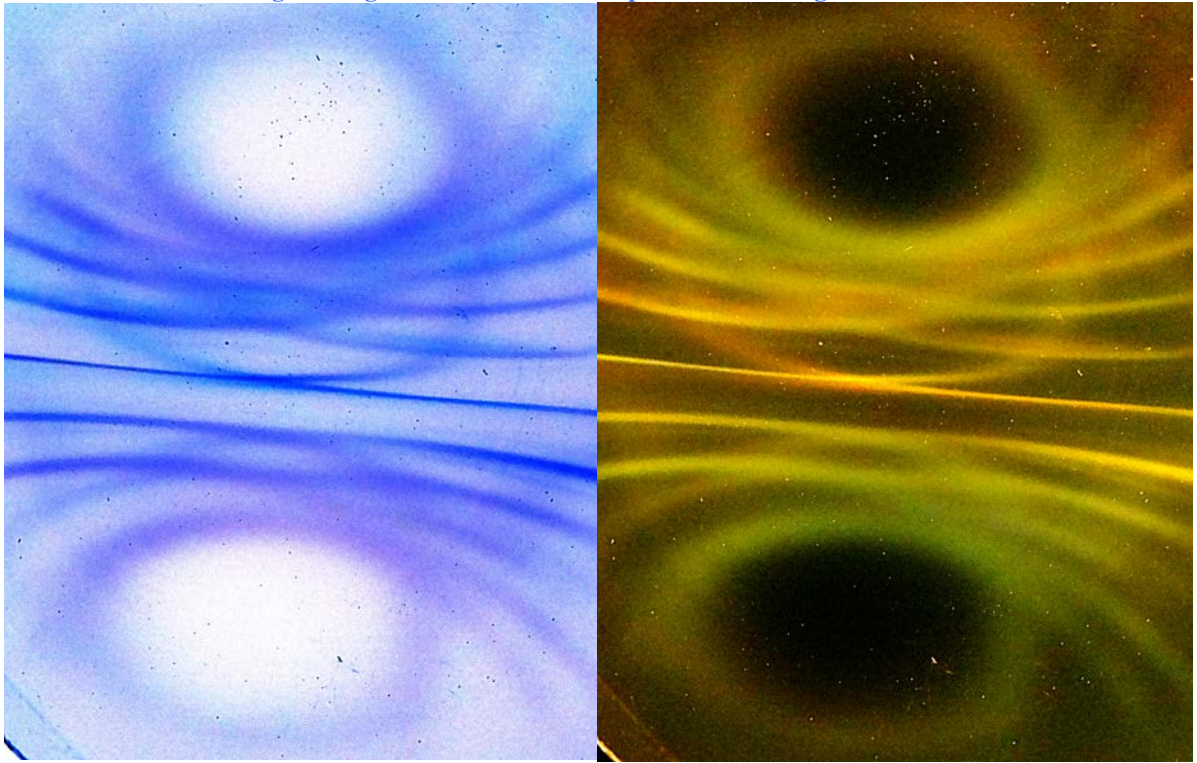

Below: [Photos courtesy of Michael Snyder of revolution-labs.com] Images created by the Timm Vanderelli ferrocell invention. Ring magnets showing the hypotrochoid formations as necessitated by dielectric voidance and centrifugal/centripetal magnetic reciprocation.

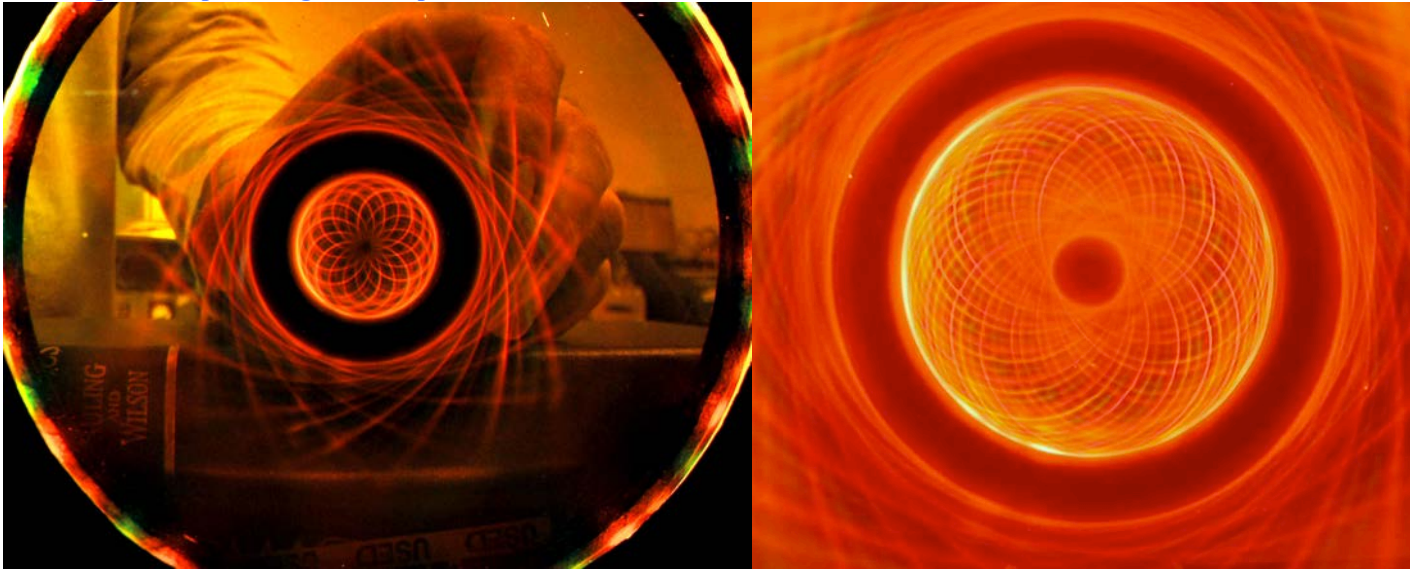

Below: [Photo courtesy of Michael Snyder of revolution-labs.com] Images created by the Timm Vanderelli ferrocell invention. Two ring magnets showing field compression from countervoidance ('repulsion').

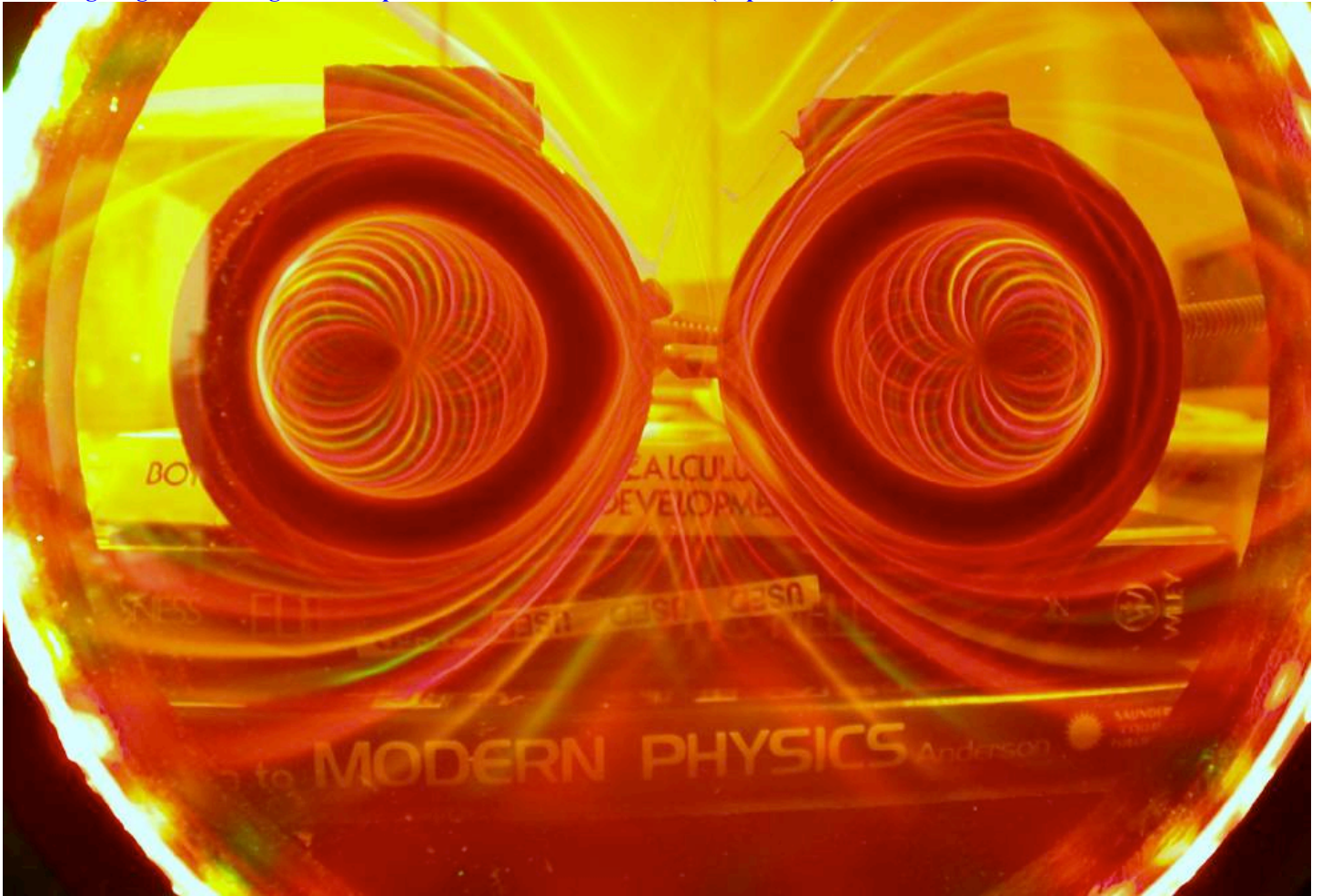

Picture of two 50.8mm ring magnets with their north poles facing the camera.

Below: [Photos courtesy of Michael Snyder of revolution-labs.com] Images created by the Timm Vanderelli ferrocell invention.

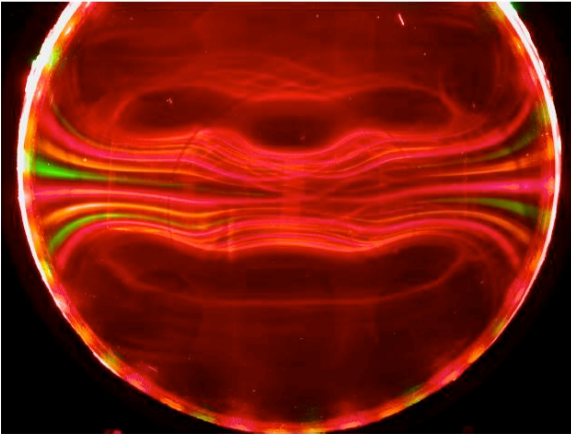

III – In this picture three 25.4mm cube neodymium magnets are held in a PVC mounting with all three north poles at the top and the south poles at the bottom. Notice the pole voids have joined together to form a larger composite magnet and the light paths are nearly continuous from side to side.

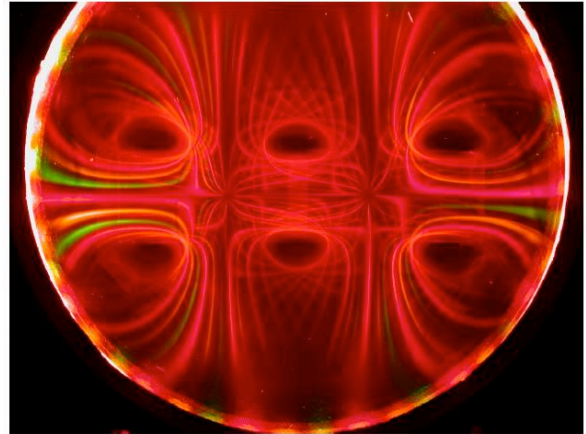

IV – In this picture the same three 25.4mm cube neodymium magnets are held in the same mounting with only the center magnet being flipped; placing an opposite pole in the middle of the configuration. Notice the Points of Inversion that have formed between the three magnets.

Below: [Photo courtesy of Michael Snyder of revolution-labs.com] Notice the color displacements, the green and yellow exist only along the dielectric inertial plane of the magnet, whereas the poles are illustrated (as they must be as per the correct model of light mentioned at the end of this work) in red and orange. Notice the depressed bowl shape formation along the faces of the cube polarizations.

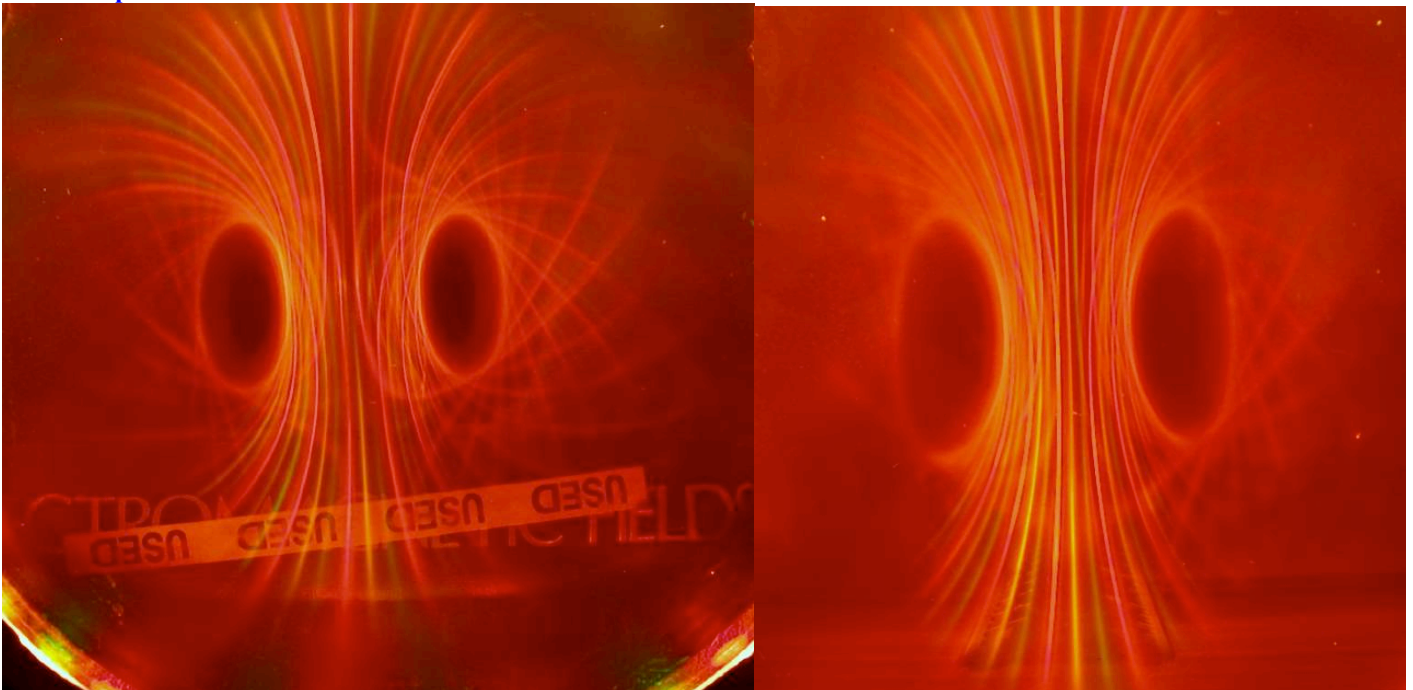

Below: [Photo courtesy of Michael Snyder of revolution-labs.com] Broken ring magnet illustrated by the Timm Vanderelli ferrocell. Notice the color displacements. The red exists along the center where there is lower dielectric voidance, and the yellow exists along the interior rim as does the green.



Below: As predicted and discovered by myself there is white light along the dielectric inertial plane of a N50 1" cube neodymium (any magnet as a matter of fact) and red and green light along the poles due their lower dielectric capacitance as illustrated by the Timm Vanderelli ferrocell. Literally the three magneto-dielectric (convergent, divergent, and dielectric) pressure field-zones of the "magnet", the divergent centrifugal, the convergent centripetal, and the dielectric inertial plane have dissected the light into its relevant constituents based upon the magnitude of their dielectric pulse compositions proportional to wavelength. The invention potentials for this discovery have yet to be fully realized but are to be sure, enormous.

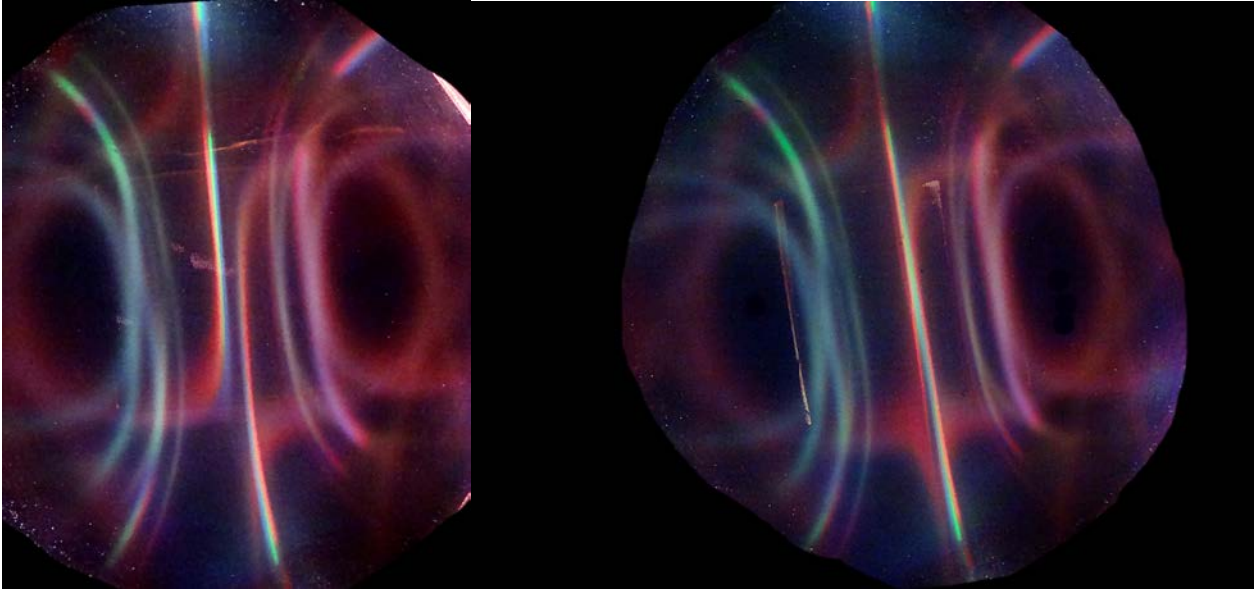

Below: [Photo courtesy of Michael Snyder of revolution-labs.com] Image on left you see a cube magnet looking corner-on behind the Timm Vanderelli ferrocell. Notice the depressed bowl shape formation along the faces of the cube polarizations. There is amazing depth from the T. Vanderelli ferrocell which clearly shows my prediction of centrifugal 'inward sloping' convergent magnetic pressure as opposed to the 'rim' of high magnetic centrifugal divergence. Image on the right you see four cube magnets creating countervoidance pressure formations; this formation will be discussed elsewhere.

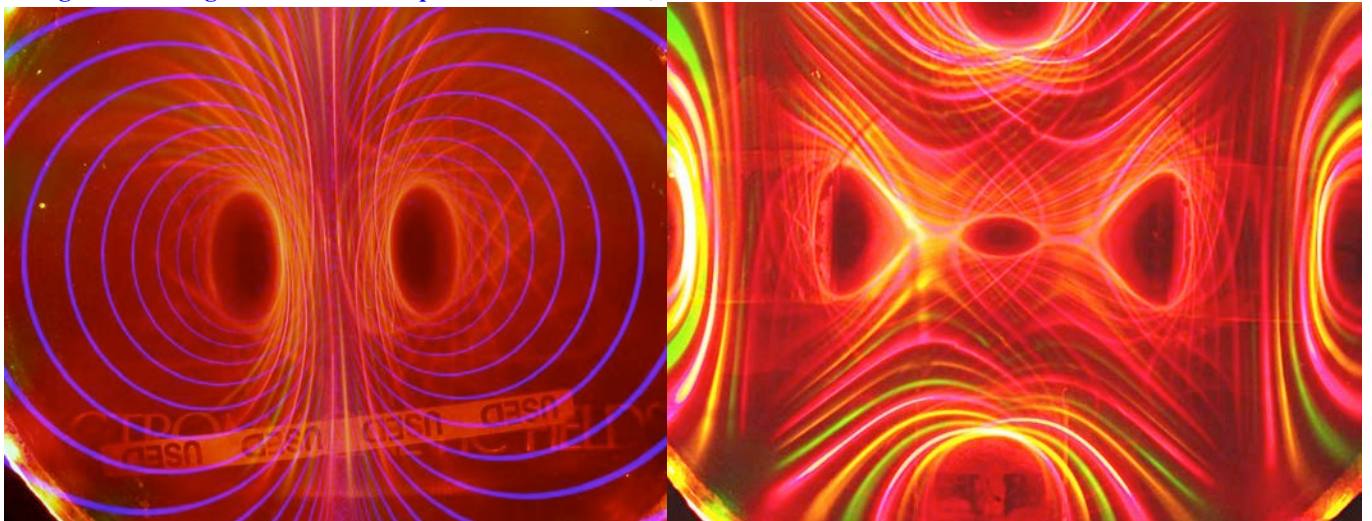

Below: [Photos courtesy of Michael Snyder of revolution-labs.com] Images created by the Timm Vanderelli ferrocell invention.

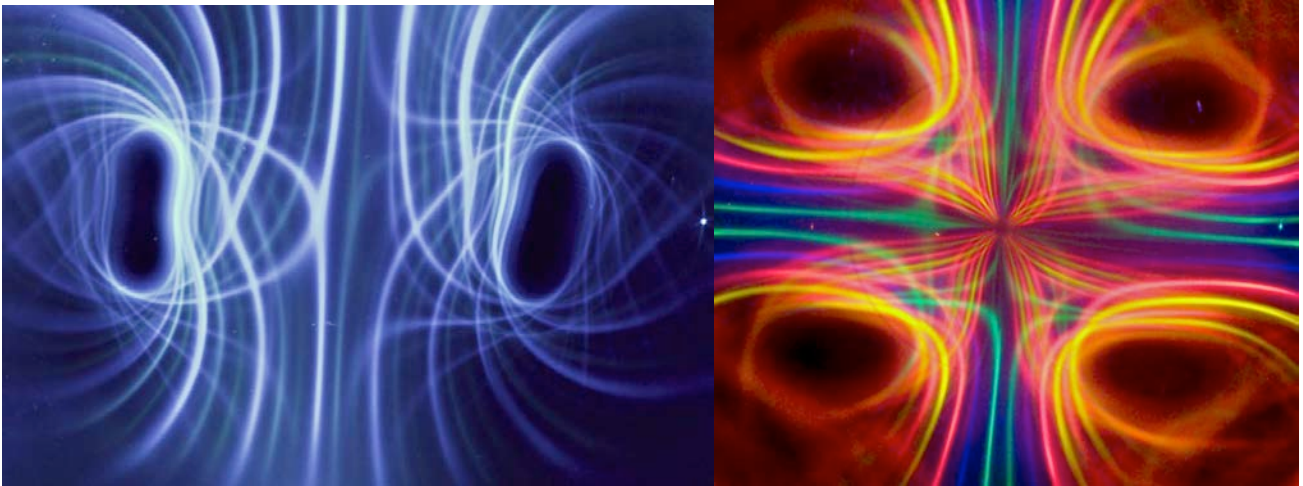

Below: [Photo courtesy of Michael Snyder of revolution-labs.com]. On left ring magnet showing hypotrochoid center; notice the higher dielectric capacitance light is on the periphery and the low dielectric capacitance red light is in the intermediate low pressure zone. On the right you see a cube magnet looking corner-on behind the Timm Vanderelli ferrocell.

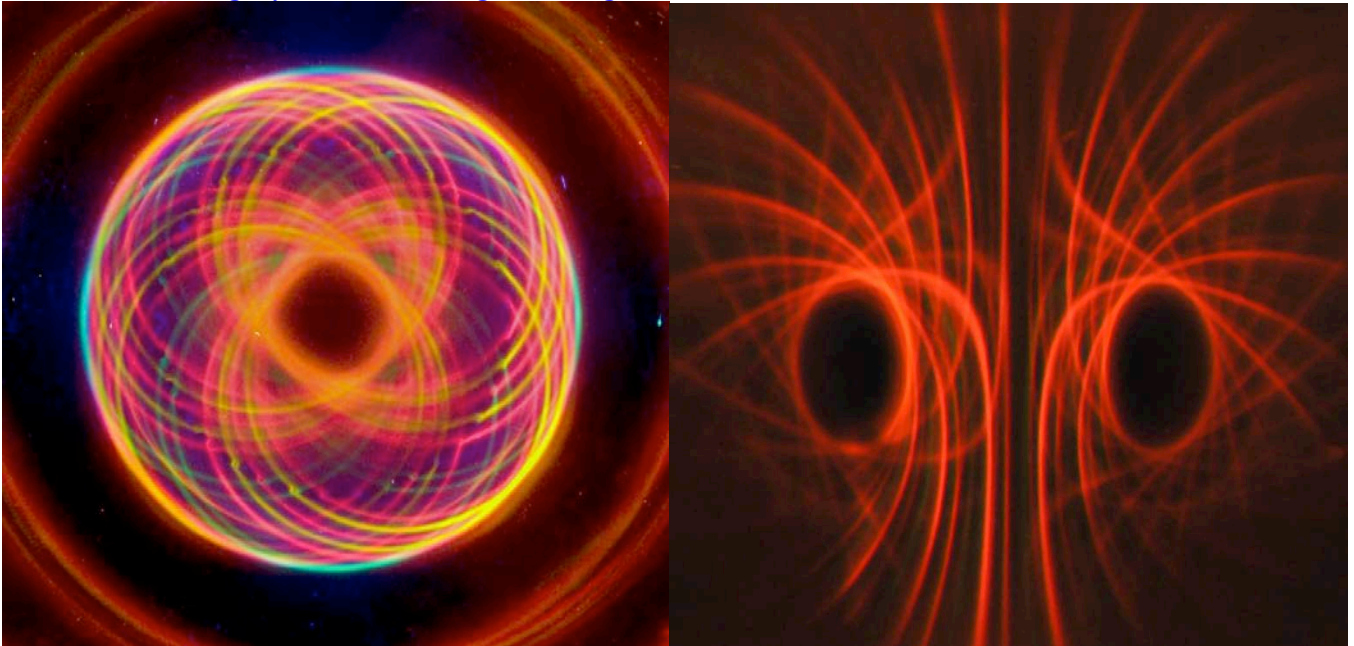

Below: [Photo courtesy of Michael Snyder of revolution-labs.com]. Image on left showing the blue and green (high Z-axis radial dielectric capacitance) being directed along the dielectric inertial plane. Image on right showing three ring magnets showing field compression from countervoidance.

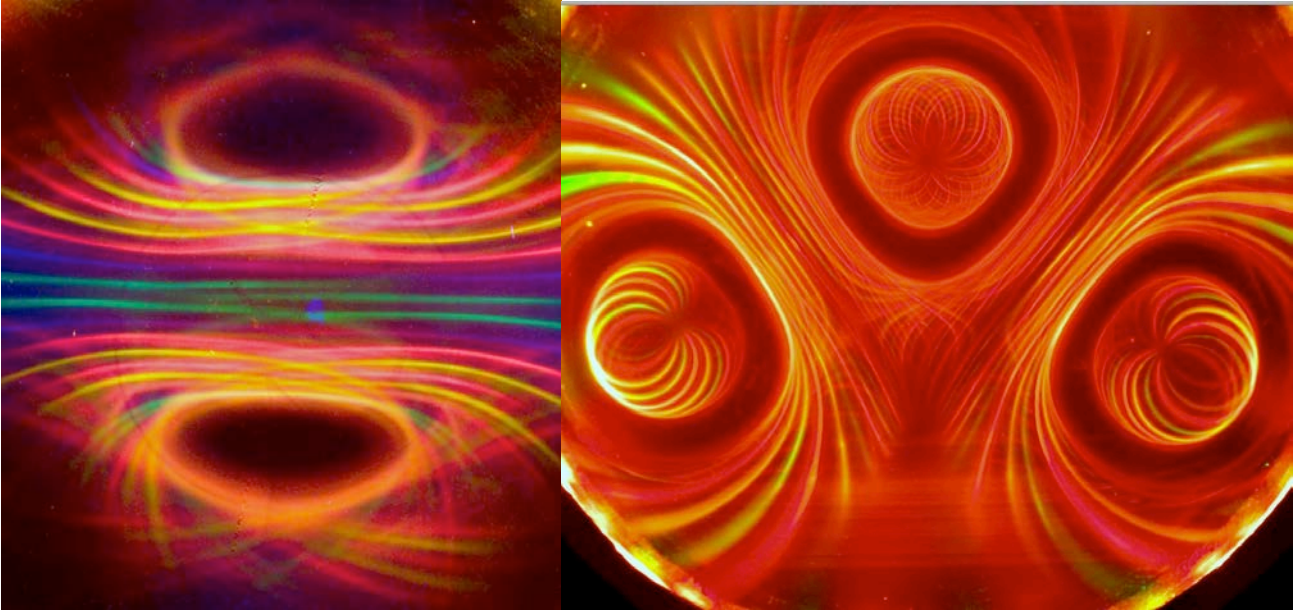

Below: [Photo courtesy of Michael Snyder of revolution-labs.com]. On the left are 3 magnets, some undergoing voidance, and the far left and right undergoing counter-voidance (repulsion). On the right is light being directed along the dielectric inertial plane of multiple magnets.

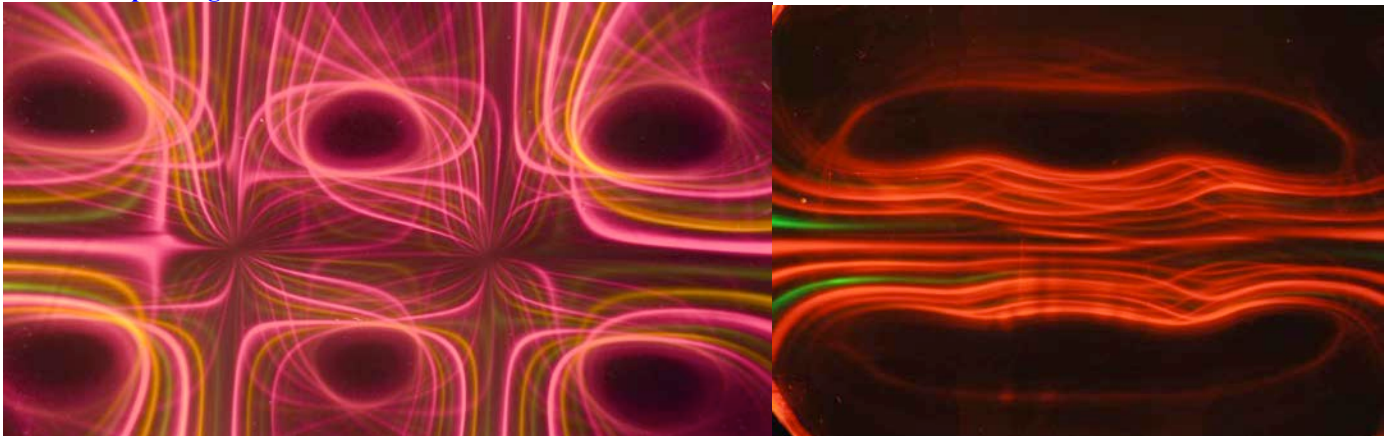

The missing secrets of XYZ-axis spatial-counterspatial geometry in the nature of dielectricity, magnetism, electricity, and gravity

“There are only four types of people in the world regarding discovery and invention:

The most common are those who watch and observe, and profit from invention and discovery; are intrigued by its discoveries.

The second most common are those who dissuade others from invention and discovery, and try to prevent them both mentally and physically from discovery claiming: ‘this can lead to nowhere’, or ‘that course is a dead end, there is nothing there.’

The third most common are greedy and lustful inventors who desire only fame, profit, and acclaim, nothing matters but any angle that can be exploited to be used to exploit others for their own ends. Discovery is not an ends to these people, only a means to exploit others.

The fourth, and most rare are those who do not care about the first three types of people; these rare few have a vision or visions and are hell-bent to uncover the mysteries of the universe, not out of desire for profit or fame or empirical motives, but the only pure, noble, and righteous intent, that being pure discovery and understanding as its own ends. The expansion of comprehension and wisdom”. – Author

When dielectricity is radial along the Z-axis, there is low pressure circulatory XY-magnetism.

When dielectricity is accretional along the XY-axis in a solenoid, permanent magnet, electromagnet, AC lines, there is dielectric distension and magnetic high-pressure jets that circulate perpendicular to the dielectric inertial plane. (However opposite, but appear as perpendicular due to the binding system pressure geometries).

Anytime there is a XY-axis dielectric accretional formation, there is a hyperbolic conjugated spatially increasing Z-axis of centrifugal and centripetal magnetic flow as idealized in a magnet or AC current in the opposite direction of transmission. (Figures 1,2,3 below).

A counterspatial dielectric ‘sphere’ or volume is radial and electro-torsional, if increased and trapped, as in the case of electrification or a magnet; it is a centripetal, toroidal XY-axis inertia plane geometrically. A spatial macro-magnetic ‘sphere’ or volume is circulatory and spatio-accumulative if increased and trapped, as in the case of electrification, or a magnet; it is centrifugal and centripetal (polarized), and a double hyperbola geometrically, and a Z-axis accumulative-formative toroid.

To understand a magnetic spatio-accumulative Z-axis toroid, occurring simultaneous with a dielectric counterspatial-accumulative XY-axis (flattened) toroid is a fundamental necessity to understanding both electrical current and the geometry of magnetism.

Below: Left, looking inside a magnet showing the dielectric inertial plane in green and the reciprocating magnetism along the Z-axis expanding spatially as polarized in spin (however this polarization is a spatial reification of distension). Image 1 showing current around a pair of AC lines, however as mentioned before, this same geometry applies to a permanent magnet if you connect the two AC lines that are the felly of the dielectric inertial plane you have the geometry of a permanent magnet. Image 2 showing the same AC current / spatial-counterspatial geometry of a magnet. The closer the felly radius of the dielectric plane (in AC lines) the greater the dielectricity, and likewise the less magnetism between the lines.

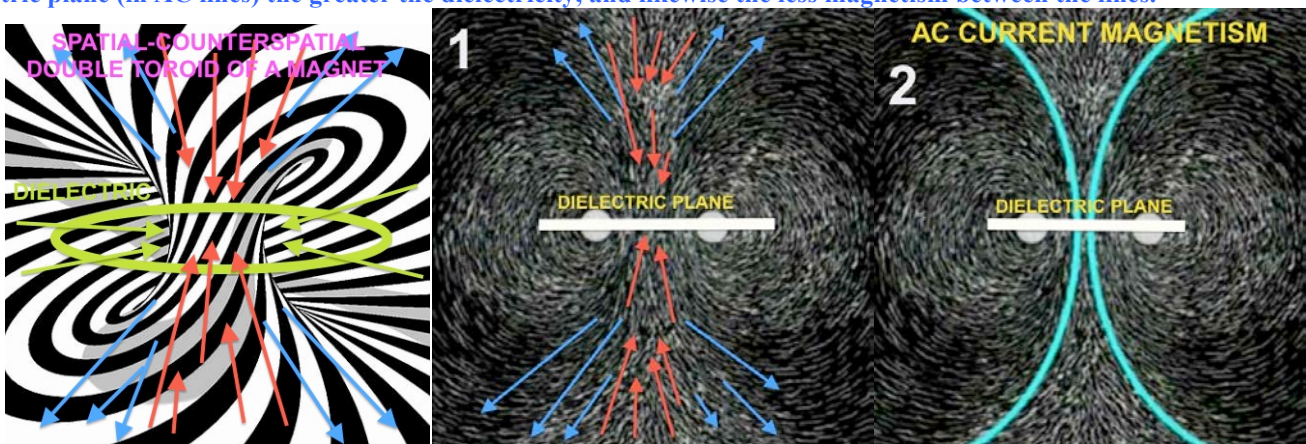

Dielectricity is either the radial centerpoint upon which dielectro-electromagnetism geometry exists, or dielectricity is the radial accretion disk of sheer magnetism. In both cases, dielectricity is centripetal and conjugates electricity, or magnetism, or both, or in strong enough fields, creates matter itself, and is likewise, the basis of and in actually what is incorrectly called the “strong nuclear force” of which the mass particle is comprised.

Dielectricity conjugates radially and centripetally along the Z-axis in dielectro-electromagnetism where electricity and magnetism reciprocate as a vortex toroidal accretion disk along the X-Y axis. In the case of magnetism, dielectricity centripetally moves along a XY-axis as an accretion disk as magnetism moves centrifugally and centripetally along the Z-axis and spatially in a curvilinear motion

towards centripetal return. In further retrodution, in the case of magnetism, the point at which the dielectric XY-axis meets, given sufficient electrification, is the point at which mass is formed.

Below: Left, current moving thru lines in the opposite directions, causing magnetism to push alternating directions of current lines apart, this is the same phenomena seen in high power AC lines. Right, current flowing in the same direction, causing the lines to be pulled close together. Likewise happens in AC lines with there is too much dielectricity running thru them.

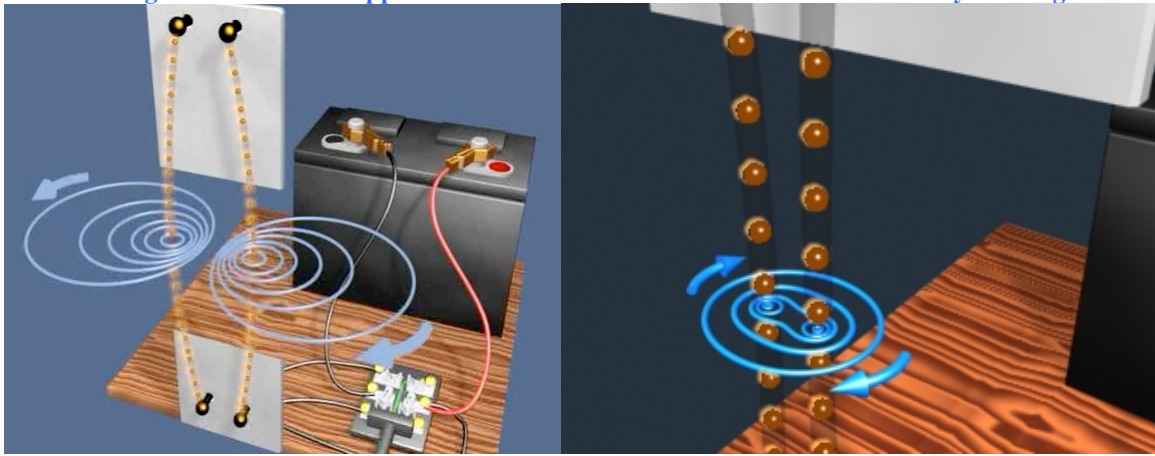

In terms of dielectro-electromagnetism vs. magnetism, the counterspatial component must exist at the Z-axis in the case of dielectro-electromagnetism, or at the XY axis in the case of magnetism in form of an accretion disk. In both cases, obviously, the movement is centripetal and inductive, or inversely, the EM components induce capacitance upon the dielectric, as in the case of dielectro-electromagnetism where perpetual reciprocating induction occurs in its natural and hyper-stable geometry.

In deduction, the radial centripetal dielectric can only exist along 2 simultaneous XY axes in the state of a magnet, solenoid, or matter itself, where the gravitational or mass geometry expands curvilinearly upon and along the Z-axis in accumulation.

A strong alternating magnetic pulsation along a magnetically ‘trapped’ dielectric accretion disk is the creation of matter.

Below: Left, a solenoid, and right a solenoid cross-section with magnetic flow shown in red.

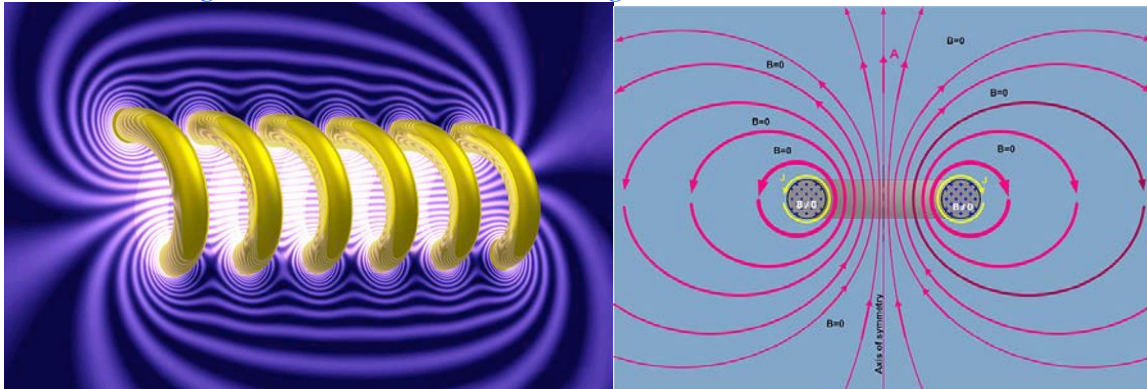

Dielectro-electromagnetism is on the counterspatial radial Z-axis and has electromagnetism at the spatial XY-axis. As electromagnetism centrifugally reciprocates along the dielectric axis, dielectricity centripetally pulsates (is induced) and radially propagates. This mutual reciprocating coaxial geometry is nature's most stable, and most common form of energy transmission. Magnetism at the circular spatial Z-axis has dielectricity at the counterspatial inertial plane of the XY-axis.

Electricity at the radial Z-axis has magnetism at the spatial circular XY-axis.

Electrification, or formation occurs at the Z-axis at which magnetism reciprocates along the X-axis upon the dielectric reflective Y-axis.

Gravity is at the counterspatial (directively, but accumulatively spatial, as mass) all-P radial-axis with magnetism, electricity and dielectricity comprising every point within its sphere. As mass centrifugally accumulates, gravitation centripetally reciprocates within the expanding radius of its field.

Below: Left, magnetic field flow around radial AC current lines, current moving in opposite directions. Image 4 shows magnetic field flow around a current moving in the same direction. Image 5 showing the dielectric inertial plant in parallel to the solenoidal windings and the resultant circular magnetic field flow around and thru the solenoid.

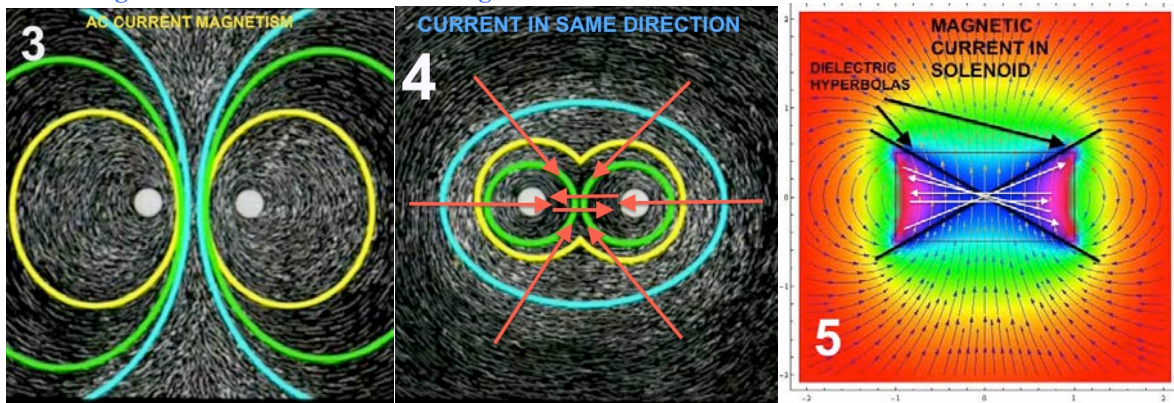

Polarization of the radial centripetal counterspatial dielectric along the XY-axis as in the case of a magnet, or AC current (figure 1), or a solenoid (figure 5), causes magnetic high-pressure circulation along the spatially increasing Z-axis (figure 2). This spatial distension of the dielectric in electrification which is by nature counterspatial, causes increasing macro-magnetic preponderances as is the case in a permanent magnet, electromagnet, solenoid, AC current and likewise.

When dielectricity is allowed to propagate along one radial axis (figure 4), magnetism is circular and of low pressure, as in the case of DC lines or conventional stable inter-atomic volumes where dielectro-magnetic volume are both in equilibrium.

The missing secrets of this geometry as pertains gravity will be revealed in another work, suffice to say that since the “strong nuclear force” in fact is dielectricity and comprises much of all atomic matter, and while magnetism provides the magnitude to mass, the overwhelming predominance of any mass is an enormous amount of dielectric energy which, like gravity is centripetal.

No part of electromagnetism (incorrectly thought of) is in one or two planes, both operate in a spiral vortex. Conjugating pressure spirals of oppositional movement define all wave-fields. It is likewise, as stated, impossible for “electromagnetism” to exist without a center radial dielectric conductor, acting as counterspatial axis for EM reciprocation.

Below: The conjugate relationship of and between magnetism and dielectricity in different current and carrier phenomena.

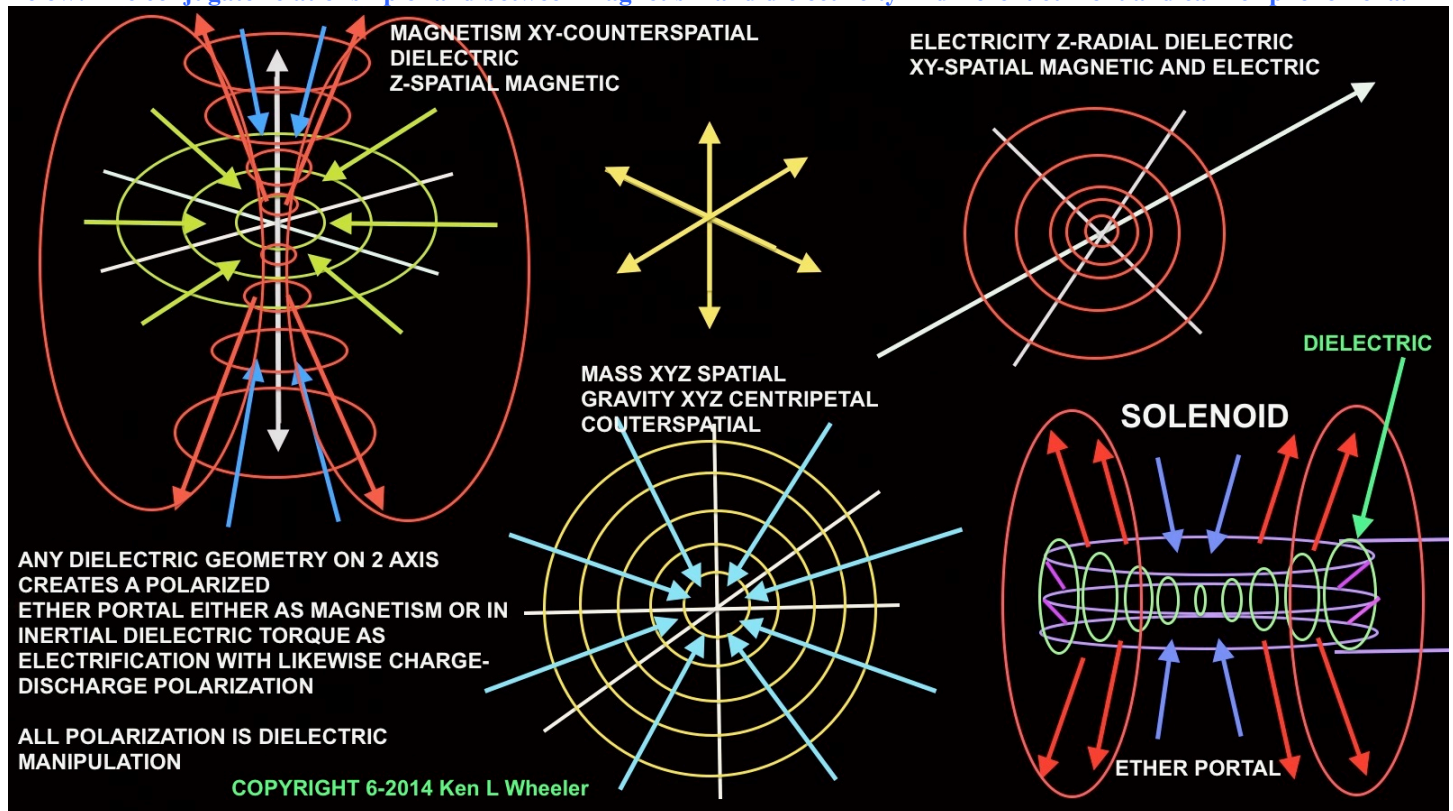

Below: Showing strictly the field geometries inside a permanent magnet. However also this would be the same geometry if one were looking down a pair of AC lines to infinity. However, while the axis vectors would be different in the AC lines, the field geometries would be identical in appearance.

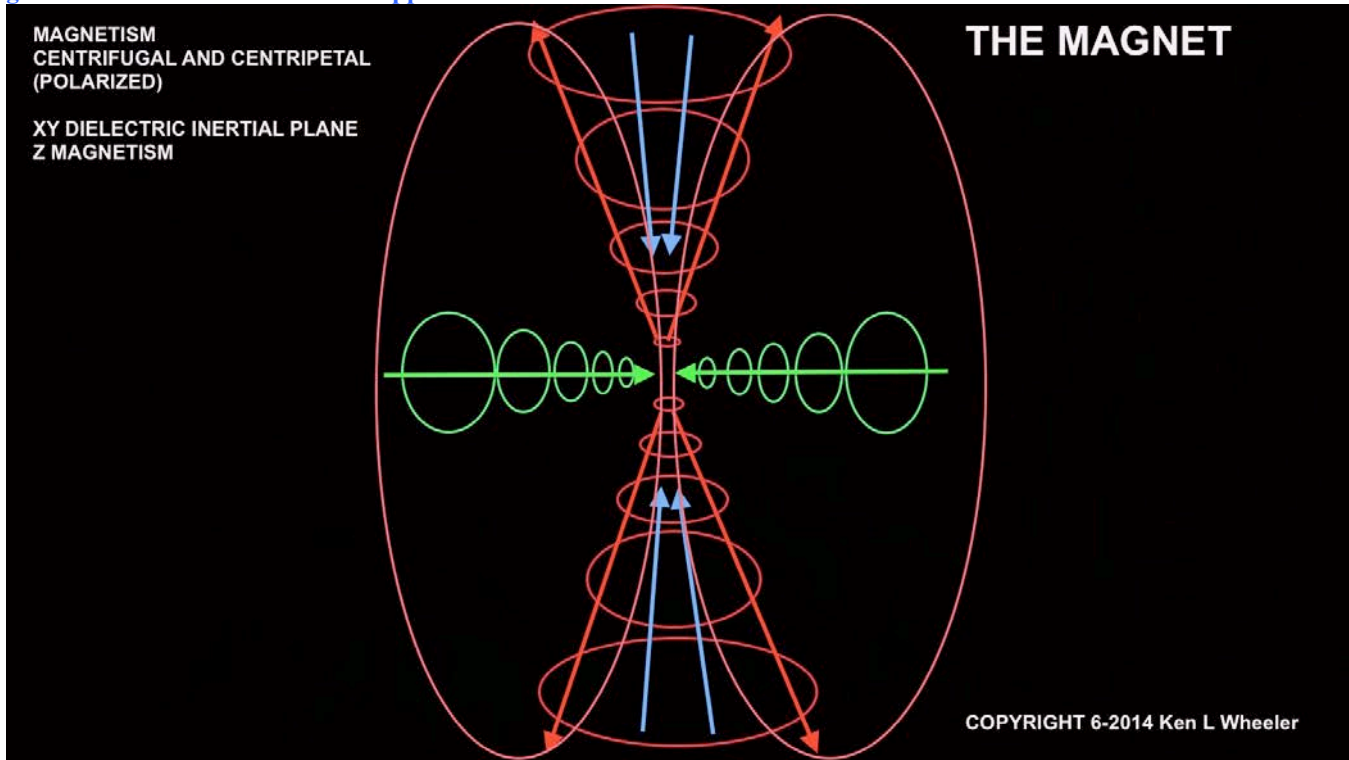

Below: The magneto-dielectric archetype, seen face on. Edge on you would be seeing the dielectric inertial plane with magnetism passing thru the axle, also the aperture of greatest centripetal return pressures. However dielectricity is purely centripetal and counterspatial. The wheel is a near perfect archetype of how both are conjugated in nature against each other, and operate in a binding system.

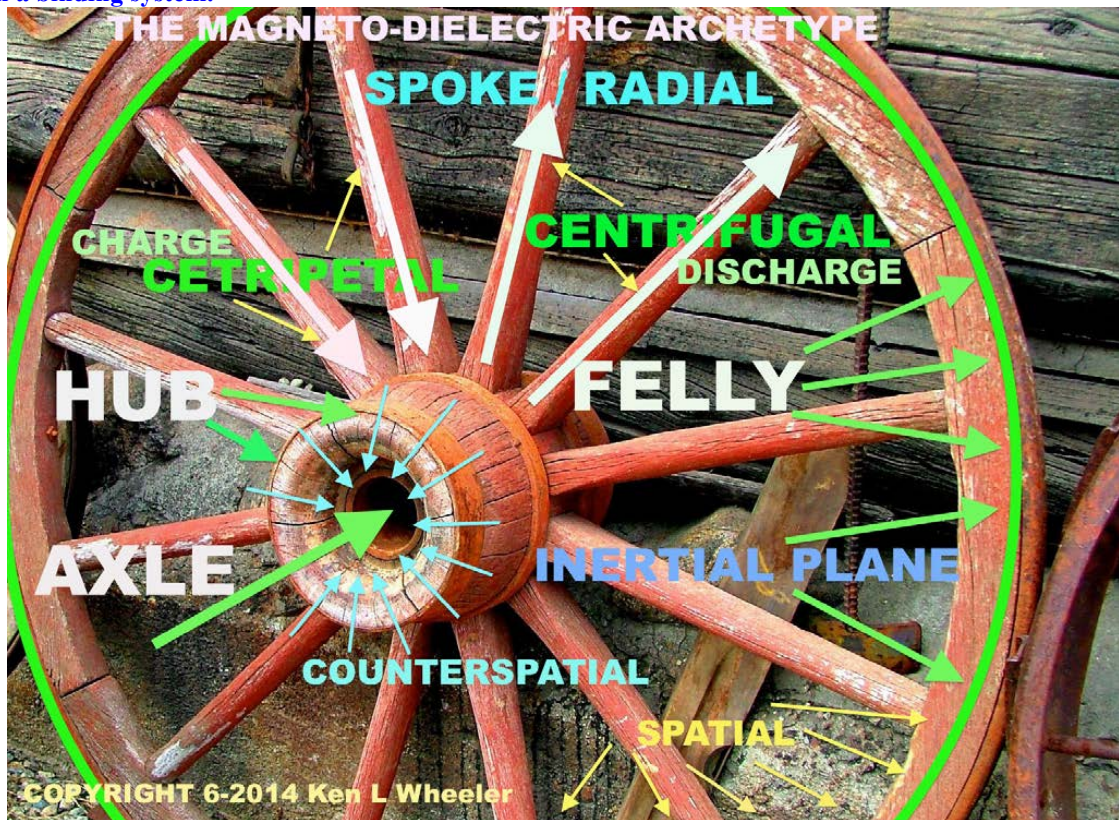

Below: Diagram 6 showing AC lines and bottom showing current in the same direction. Right, magneto-dielectric field-line archetype seen edge-on as per the dielectric, and expanding vertically along the Z-axis is the reciprocating conjugate magnetism. This is the archetype of field incommensurability. Self-similarity and inverse spatial-counterspatial field mechanics.

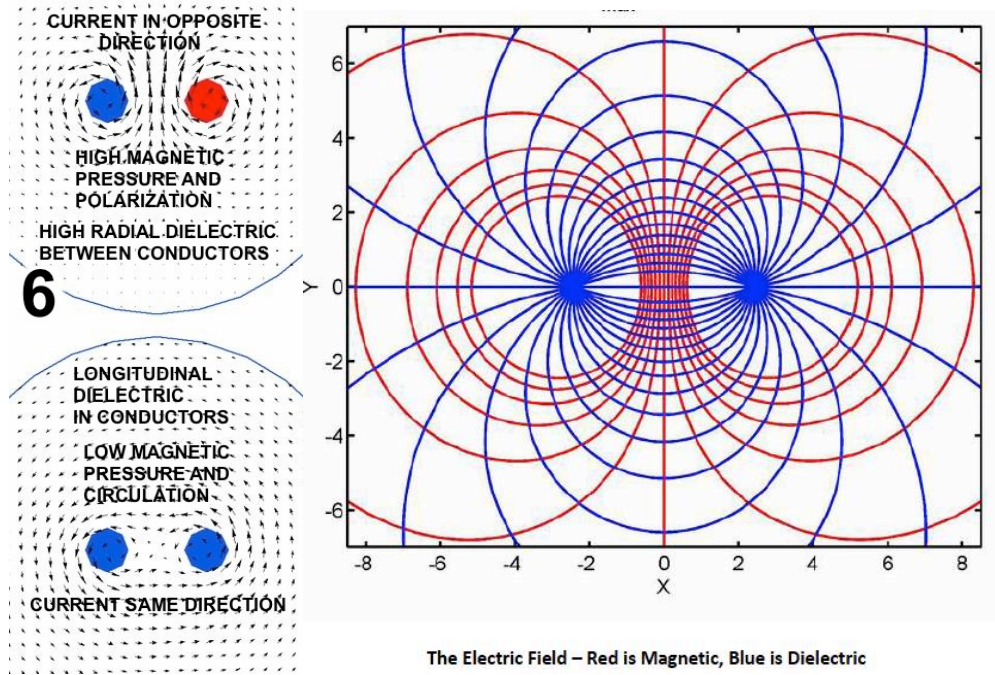

Gravity

Laithwaite's efforts to show the weight loss of the gyroscopic devices he built were met with 'utter hostility'. He retired from Imperial College in 1981 pretty much in disgrace. But he never lost his fascination for gyroscopes. "None of my critics could ever explain to me how a 50 pound spinning wheel loses weight," - **Prof. Eric Laithwaite**

"Supposing that the bodies act upon the surrounding space causing curving of the same, it appears to my simple mind that the curved spaces must react on the bodies, and producing the opposite effects, straightening out the curves. Since action and reaction are coexistent, it follows that the supposed curvature of space is entirely impossible - But even if it existed it would not explain the motions of the bodies as observed. Only the existence of a field of force can account for the motions of the bodies as observed, and its assumption dispenses with space curvature. **All literature on this subject is futile and destined to oblivion.** So are all attempts to explain the workings of the universe without recognizing the existence of the ether and the indispensable function it plays in the phenomena." "My second discovery was of a physical truth of the greatest importance. As I have searched the entire scientific records in more than a half dozen languages for a long time without finding the least anticipation, I consider myself the original discoverer of this truth, which can be expressed by the statement: There is no energy in matter other than that received from the environment." — **Nikola Tesla**

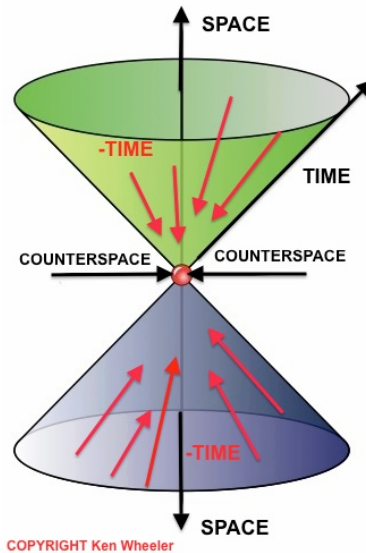

Since this is an article about magnetism, mass / gravity only rates for a brief mention here.

Gravity's genesis from dielectricity must be a zero movement fulcrum compression where matter is spontaneously generated at the hub of the rebounding inertial plane. As is the case, weight is location specific, and medium specific (water etc.), likewise rotationally specific [in the Ether medium] (gyroscopic).

Just as the dielectric inertial plane ('Bloch wall' in incorrect nomenclature) is immediately self-seeking when two magnets are brought together, so too are any two masses at which time the center of gravity shifts. Dielectricity is to gravitation as electricity is to magnetism.

The current concept that the cosmos and the interatomic model is or are 'mostly empty space' is the greatest mental perversity perpetrated upon humans as against the genuine rational and logical understanding of the mechanics of the cosmos.

Humanity holds many insane notions about gravity, that it has a locus, but a field is well defined. If one were able to stand within a small bubble inside the center of the Earth or Sun, they would be weightless. Weight is location and medium specific. So, being at the center of gravity for a stellar mass (hypothetically) how is it then that one is weightless? For the very same reason that there is no magnetism along the fine line of the dielectric inertial plane of even the most very powerful neodymium magnets. This discussion is saved for another article.

Even the gyroscopic precessional movement of the earth is in fact due to the centripetal magnetic returning vortex which displaces the geographic north from the magnetic pole. Mass creation is from a dielectric centripetal termination through a peak magnetic aperture.

Below: Force Unification Diagram showing the nature of fields, their terminations, and accumulations regarding the four forces in the cosmos; how they interact and likewise their conjugate natures. Dielectricity and magnetism are co-principles; electricity and gravity/mass are secondary attributes created between interactions of magnetism and dielectricity.

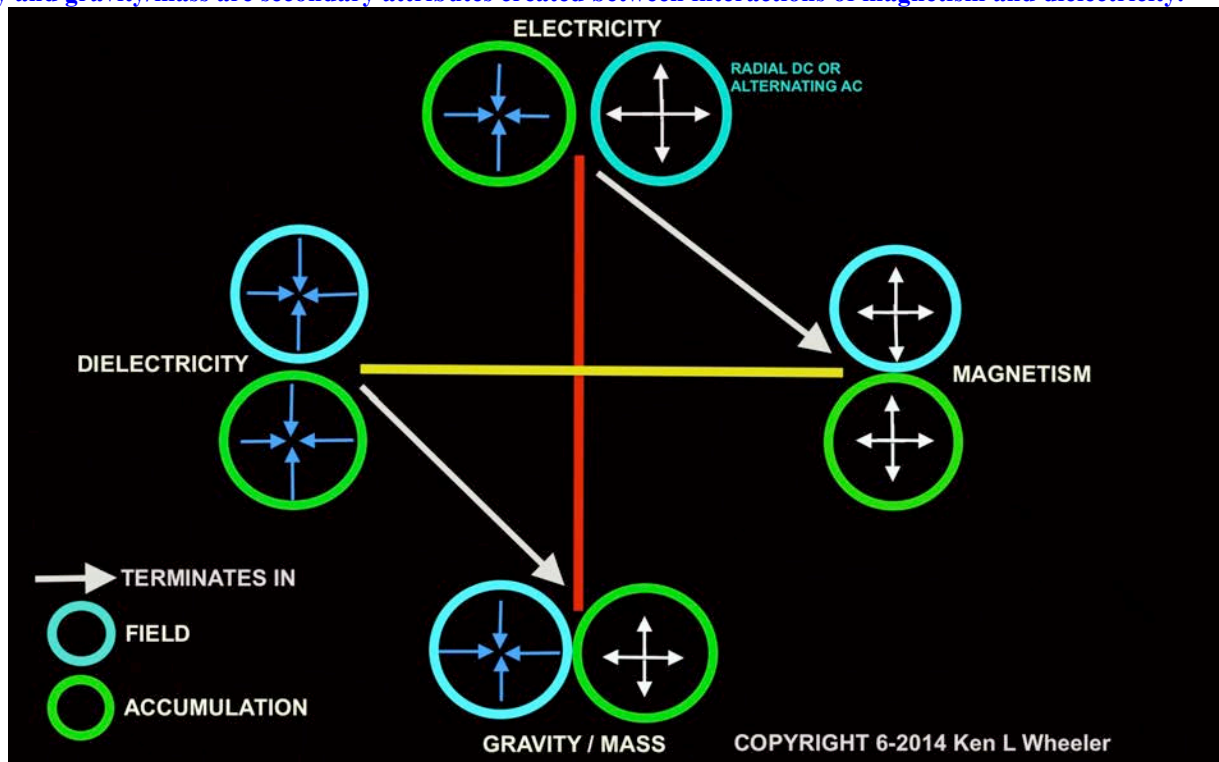

Matter does not attract matter, rather the “strong nuclear force” which is in fact simplex dielectricity that causes an accumulative centripetal Ether vortex which accelerates masses towards each other in equilibrium seeking pressure gradients.

Magnetic polarity is centrifugally spatial and centripetally counterspatial, just as the two other “poles” are dielectrically accumulative in the counterspatial and gravitationally accumulative in the spatial, as matter itself. This double conjugated zero-null fulcrum of both the magnetic and the dielectric-gravitational, are radiative and generative both spatially and likewise counterspatially in their field.

Matter and magnetism, both being polarized, accumulate spatially while their inertial pairs electricity and dielectricity accumulate in the counterspatial.

Magnetomotive force: $F = \Phi \times R$

Dielectric force = $\Phi/L \times T$ (Weber per centimeter-second)

Magnetic force = $\Psi/L \times T$ (Coulombs per centimeter-second)

Electromagnetic induction: E (volts) = Φ/time

Magneto-dielectric induction: I (Amps) = Ψ/time

All fields can be typified and explained very simply. All fields, whether gravitational, dielectric, magnetic, or charged are spatial to counterspatial, or counterspatial to spatial imbalances against an equilibrium fulcrum. Either magnetic against dielectric, or otherwise. Spatial-counterspatial electro-geometric imbalances are the premise and definition of any and all fields.

All induction is centripetal, magnetism and gravity alike. Gravimetric induction is a centripetal pressure gradient sourced at the inertial plane of the atomic nucleal mass whose vacuum pressure gradient is omnidirectional but propagated along the inertial plane towards the nucleal.

Smashing incoherent magneto-dielectric spheres into gyroscopic E.M.F. and M.M.F disks

Unlike magnetism dielectric energy is forced or compressed inwards rather than outwards. Dielectric lines of force push inward into internal space and along axis, rather than pushed outward broadside to axis as in the magnetic field. Because **the lines are mutually repellent** certain amounts of broadside or transverse motion can be expected but the phenomena is basically radial. This gives rise to an interesting paradox that will be noticed with capacity. This is that the smaller the space bounded by the conducting structure the more energy that can be stored. This is the exact opposite of magnetism. With magnetism, the units volumes of energy can be thought of as working in parallel but the unit volumes of energy in association with dielectricity can be thought of as working in series. –**E. Dollard**

“One clear thinker is worth a thousand deep thinkers who cannot see clearly” – **Author**

All matter is in motion, whether evident or not, creating phase coherent electrical archetypes in imitation of nature or as exists in nature are all equalization seeking pressure gradients of fields, electrical, dielectric, magnetic, and gravitational. Humanity is fascinated by “magnets” (as I have been my entire life) only that they are an electrical gyroscope with their own inertial plane, magnetic axis, and macro-atomic influences which have amazed mankind since the discovery of the loadstone. The creation of a dielectric ‘gyroscope’ of electromotive momentum by electrification creates a spatially expansive axis of circular centripetal and centrifugal momentum along the perpendicular axis to the dielectric inertial plane.

An entirely new science will be born one day, which investigates magneto-dielectrical electro-gyroscopic principles. Already they are being studied very loosely as in the situation of electro-motive forces and magneto-motive forces. Circular radiative magneto-motive force is like a multi-plane gyroscope, which expands along the Z-axis perpendicular to the XY-dielectric in the case of a magnet. In knowing the energy vector of any component of fields, determining the location of the other is simplex enough, regardless if radial, circular, spatial or counterspatial, it’s perpendicular can easily be known.

Below: Left, archetypes of spatial-counterspatial energy. Right, simplex magnetic and dielectric generation formulas.

Arc-typical Forms of Energy Movement

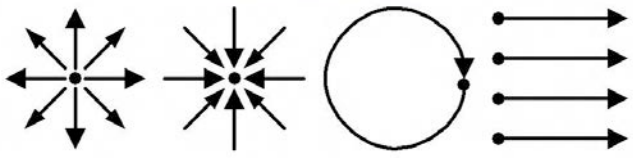

SPATIAL COUNTERSPATIAL CIRCULAR RADIAL

		Magnetic			
V	$\frac{\phi}{t} = E$	Electro-Motive Force	Magneto-Motive Force	$i = \frac{\phi}{L}$	A
	$\frac{\psi}{C} = e$	Electro-Static Potential	Displacement Current	$I = \frac{\psi}{t}$	
		Dielectric			

The magnetic “flywheel” of magnetic motion is spatially expansive along the Z-axis with perfect gyroscopic perfection at the angle of 90 degrees to the inertial plane of dielectricity at the XY-axis of the “magnet”.

Precessional movement of the dielectric occurs with magnetism over time against the dielectric plane at 90 degrees, which manifest electrification at 90 degrees to the dielectric plane. Likewise is the case of moving a magnet against the dielectric plane. This dielectrical torque is and causes electrification.

Overcoming the magneto-dielectric field momentum at the atomic volume is discharge; and this is the wrong conception of ‘electrons’ or ‘discharge carriers’. This is exactly like pulling on rubber bands until they snap their field lines in electrical transmission or vacuum tubes.

Electrification of a ferrous or iron-neodymium mass creates the magneto-dielectric stable “magnet” due to the irons magneto-dielectric ‘elasticity’, which is of course, a dielectrically saturated object with dominant dielectricity with coincidental attributional magnetism. We only consider it a “magnet” such that dielectricity is centripetal, counterspatial, inertial, and radial, or from human senses, a conventional ‘unknown’ dominant force.

Below: Understand a superluminal dielectric radial plane, a ‘charging gyroscope’ of pure potential. This is the basis behind most of Tesla’s works, comprehension and manipulation of dielectricity, not electricity.

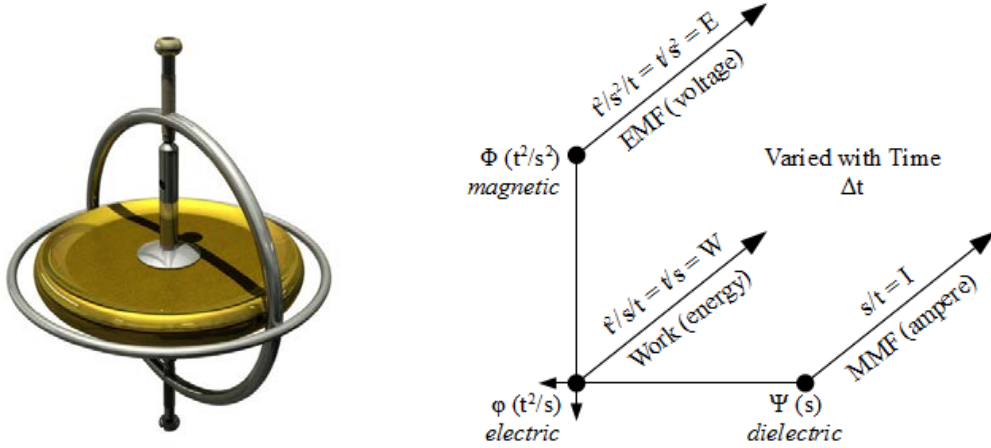

The magneto-dielectric gyroscopic axis contracts and become coherent along and radially around the Z-axis in electrification in creating a magnet, these conjugating pairs of electrical archetypes create nature’s golden section geometry both spatially and in charge dissipation as they reciprocate against one another and thru themselves. The inertial planes of momentum of both the magnetic and the dielectric are distended in the creation of a “magnet” creating edge-point stability, identical to a child’s gyroscope which can balance perfectly, a large mass at the imaginary point of a needle by mere centripetal-centrifugal magneto-dielectric momentum. However the heresy of GR and QM is that all atoms are 99.999999999% empty space, which is both insane, illogical, and contradicts all known observation and offends the common sense of an illiterate person. Einstein’s dumb giant, GR, still roams the lands stepping on people’s necks.

Below: Electrification in the creation of a magnet causes inertial dielectric coherent dominance by centripetal electrical momentum. This creates, in perfectly logical order, a model the same as this charged atomic ion:

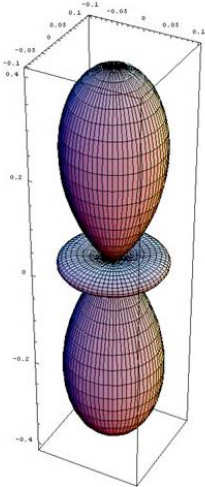

The dielectric inertial plane, or “Bloch wall”. Correcting the magnetic ‘domain wall’ fallacy

“What is perchance, in all human history of examining what a magnet is, we have been looking at a horses ass rather than the horses mouth? This I assure you is in fact the case.” - Author

The insane premise today in looking up the definition of a “domain wall” or “Bloch wall” is: “A domain wall: interface separating magnetic domains. A Bloch wall is a narrow transition region at the boundary between”. This is nonsense and reifies the false concept that this moving divider is like an imaginary cage that separates the lions from their pray (CW and CCW) at the zoo. This dielectric inertial plane is the basis for understanding dielectricity, counterspace, the creation of a magnet, AC transmission lines, and the entire spatial-counterspatial magneto-dielectric geometry that governs the entire cosmos. That modern science had only devoted an insane and incorrect tiny footnote to this only shows how very little current science understands the magnetic and dielectric universe.

The Bloch wall of any magnet is, in simple, the dielectric accretion disk. This is the very reason why there is absolutely no magnetic attraction at the dielectric plane of even an extremely powerful magnet. Magnetism does not exist at this very narrow accretion disk of centripetal dielectricity. This dielectric pressure equilibrium is a necessitated entity in any magnetic system, permanent or otherwise. There cannot exist any magnetic fulcrum without a dielectric inertial plane. In bringing two magnets together, this inertial plane will immediately shift from the middle of one magnet to the center between the two as the inverse spins of the magnetic inductions self-void at the counterspatial dielectric inertial plane. An incapacity to grasp this visually and mentally is a permanent roadblock to any comprehension.

This dielectric inertial plane is the counterspatial XY-axis of non-opposition between magnetic circular reciprocation centrifugally and centripetally, which create, as is necessitated, binary CW and CCW field lines of motional disturbance. At the dielectric inertial line the two reciprocating magnetic field gradients are nullified and in equilibrium.

In motion, force has the illusion of existence. In inertia, force exists as a potentiality without the illusion of motion. When an event takes place "anywhere" in the universe the concept of that event is simultaneously measured in inertia "throughout" the cosmos of counterspace.

The inertial line is that hypothetical line of absolute non-opposition between the oscillations of the two opposing forces of motion. At the inertial line the two opposing forces are neutralized and in equilibrium. At the inertial line there is no force back of motion but there is the impetus of the magnetic radiative pulsations which continues motion across the inertial plane without force.

That state of motion which continues its inertial radial motion without force-back from it should be known as inertial energy. This inertia can of course be brought into precession in the case of electrification production, or in the termination of electrification in the creation of a permanent magnet or electromagnet.

“Magnetic Inductance is thus a dimensional relation for the magnetic properties of the Ether, and dielectric capacitance is a counterspatial relation for the dielectric properties of the Ether. Inductance and Capacitance are the application of metrical relationships to certain attributes of the Ether. Both additive in (magnetism) either +space and +time, and the other (dielectricity) multiplicative in either –space and –time.

For the magnetic induction the Ether modality relation is the magnetic “Permeability”, for the dielectric induction the Etheric relation is the dielectric “Permittivity”. These were coined by Oliver Heaviside. Permeability is denoted as Mu, the Permittivity as Epsilon. These two relations represent the “Magnetic Inductivity” and the “Dielectric Inductivity”.

The reason Rawls and Davis wrongly and correctly thought that magnetism traveling from pole to pole actually traveled to the outside center of the magnet is that the magnetic pressures insufficient to clear the dielectric accretion disk is directed towards the boundary inertial dielectric plane at which it returns with least resistance. Depending on gauss rating and the geometry of the magnet upon centrifugal ejection, a large portion of the magnetism returns at the CW or CCW pole and a large portion of the magnetism with insufficient escape pressure is directed at the outer centerpoint of the magnet where the dielectric inertial accretion disk ‘reaccepts’ the magnetism as necessitated by field pressure gradients. This is the reason behind their incorrect yet partially accurate observations.

Below: Centrifugal intermediate pressure gradients with insufficient velocity to overcome the felly of the dielectric inertial plane.

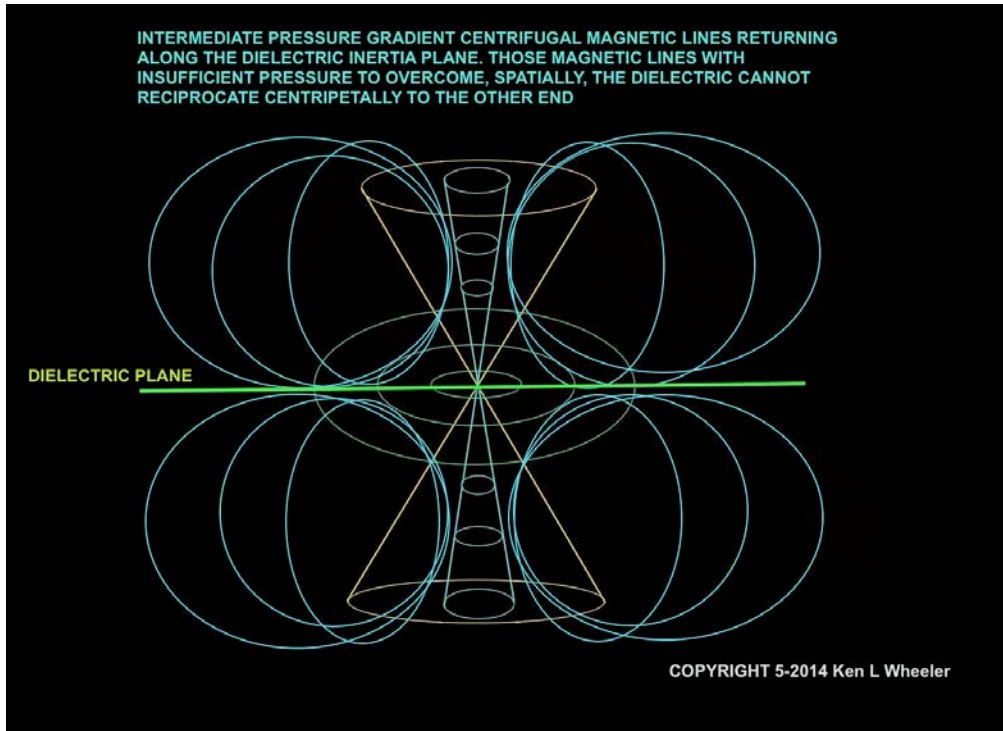

The dielectric inertial plane of any magnet is the fulcrum and reciprocating ‘crank shaft’ at which magnetism rebounds and begins again.

When two magnets are brought together, the dielectric inertial plane will immediately shift to the centerpoint between the two magnets. This centripetal self-centering attribute of dielectricity behaves in an identical fashion to gravity, which, when two masses are brought together, the center of gravity will shift. That dielectricity is the point causation for the creation of mass/gravity is no coincidence in this phenomena.

Dielectric torque in the creation of electrification from magnetism

When a magnet is spun against a dielectric reflector, not only is there torsional inertia against the dielectric but at quarter turns there is dielectric vacuum torsion on the dielectric reflector.

The dielectric inertial torque is a breaking upon the superluminal dielectric at the atomic scale within the inter-atomic mageto-dielectric volume. This breaking and vacuum torque occurring at quarter turns is the point of electrification. This oscillatory compression and vacuum pressure on the dielectric inter-atomic inertia is the production of electrification.

Magnetic oscillations against the centripetal counterspatial radial dielectric on the inter-atomic dielectric of the dielectric reflector (copper, silver etc.) cause both superluminal dielectric precession, breaking and quarter-turn dielectric vacuum perturbations at the Z-axis of the dielectric gyroscopic motions. This combinational dielectric torque creates electrification at 90 degrees to the interatomic dielectric Z-axis along the temporary XY-axis of the dielectric plane, or as meant radially along the ‘conductor’.

Below: The process of electrification in creating a permanent magnet, or the process of dielectric coherence from induction.

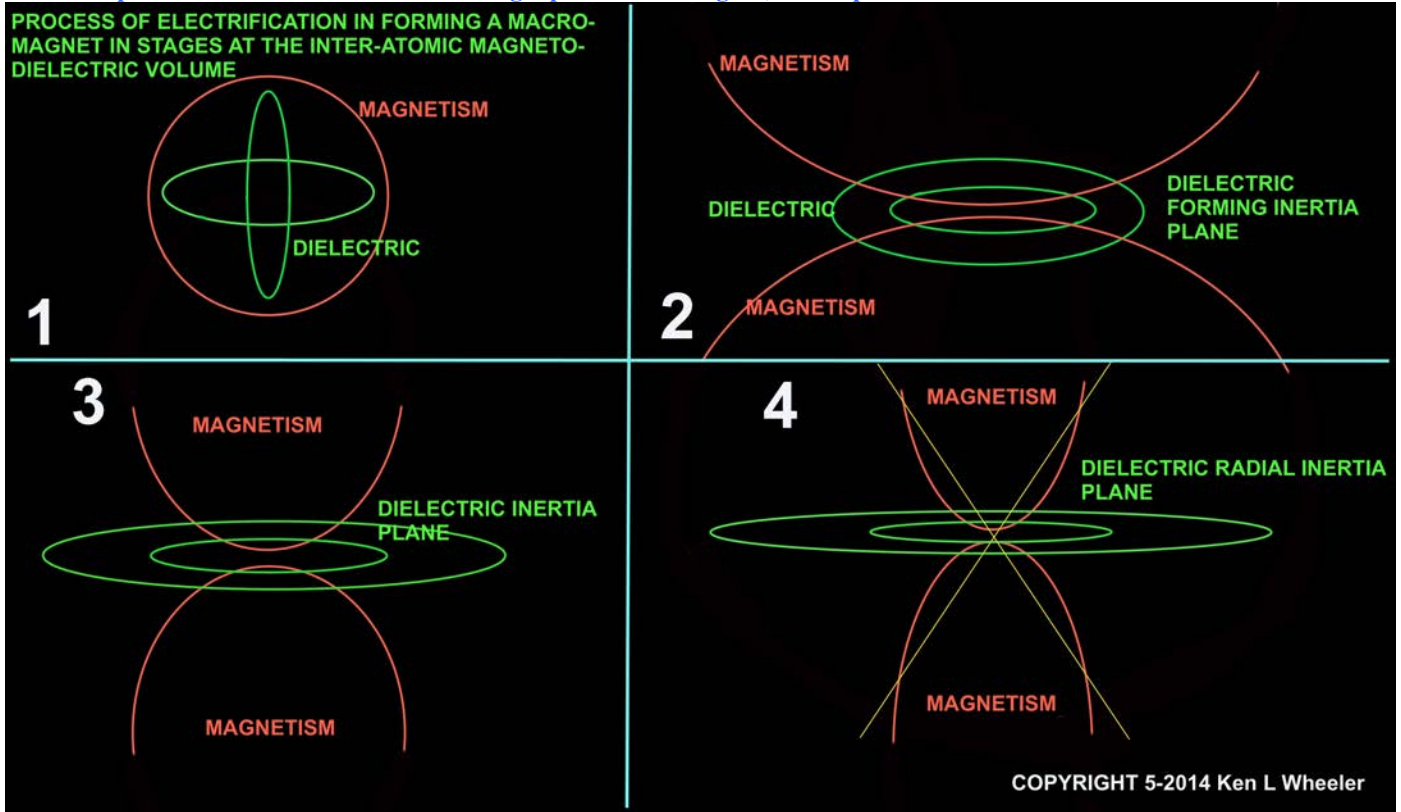

Below: Likewise again, the process of electrification in creating a permanent magnet, or the process of dielectric coherence from induction. Coherent dielectric capacitance or increased dielectric capacitance with resultant magneto-dielectric coherent conjugation in a binding system.



The atomic nuclear is the axle or hub of the dielectric radial charging gyroscopic inertial plane. These processional oscillations caused by magnetism against this hub causes dielectric perturbations and breaking leading to electrification. As is known, magnetism and the dielectric both move 180 degrees from one another, dielectricity counterspatially and in the case of charging, magnetism moves spatially in conjugated hyperbolas. However since they are in bounding seems, they appear geometrically perpendicular, but are not. The axle of the dielectric in the magnetic reflector (a reflector that is dielectrically 'inelastic') is at every location within the medium as against magnetic compressional torque of the dielectric inertial plane.

Since gravity and dielectricity are conjugated pairs like electricity and magnetism, the magnetic oscillations against the dielectric axle is the hub of electrification, which is caused from precessional vibration from the magnetic oscillations.

Dielectricity is a superluminal radial and counterspatial inertial plane in the inter-atomic; the precessional torque (breaking) forces placed upon this inertial dielectric plane by magnetism causes luminal electrification ‘remnants’ from this breaking force. The superluminal dielectric moving in a direction of opposition to the magnetic spatial field is the electromotive force in the creation of electricity. As dielectricity moves away from the magnetic, these luminal velocity electrifications are created from the breaking-torque against the dielectric like a stone creating ripples in a placid pond which has surface tension (dielectrical inertial tension, i.e. the Ether membrane).

Magnetism breaking upon the dielectric inertial plane registers that superluminal breaking out in electrification. The pulsating breaking from magnetic movement against the dielectric reflector necessitates this inter-atomic dielectric volume to emanate a polarized charge resultantly.

The dielectric “flywheel” of centripetal gyroscopic inertia is superluminal, and its inertial tension is enormous. The acting magnetic distension-breaking upon the dielectric and vacuum attraction at quarter-cycles is the premise for and of all electrification.

Quite literally magnetic polarization torque-breaking upon the dielectric centripetal gyroscopic inter-atomic produces the Ether in electrification, a state of dynamic polarization. The dielectric is the inertial counterspatial radial and centripetal intermediary for the creation of electrification; or inversely from electrification, the production of magnetism wherein electricity terminates. Dielectricity terminates in and as mass, incorrectly deemed the “strong nuclear force”.

The dielectric inertial torque occurring from magnetic-dielectric-magnetic-dielectric (as the sweeping magnet passes the conductor at both fields and at both sides of its inertial plane) oscillations is breaking the inter-atomic dielectric equilibrium causing perpendicular electrification to occur at the lateral gyroscopic-radial dielectric inertial plane at the felly, or radius of the membrane torque.

Below: Geometry for a permanent magnet, electrification, and AC transmission lines (even TEM, however TEM is much harder to represent in 3D) are all conjugate relationships. Centrifugal magnetism in blue arrows, centripetal in red, dielectricity in yellow. The dielectric centripetal inertial plane far left on the magnet in green arrows. Far right is the dielectric flow in the AC lines seen edge-on. These are all the conjugate relationships between counterspace and space. Middle diagram, the Planck, or electrification shown. In electrification, both the centripetal and centrifugal sweep the reflector, or so-called conductor.

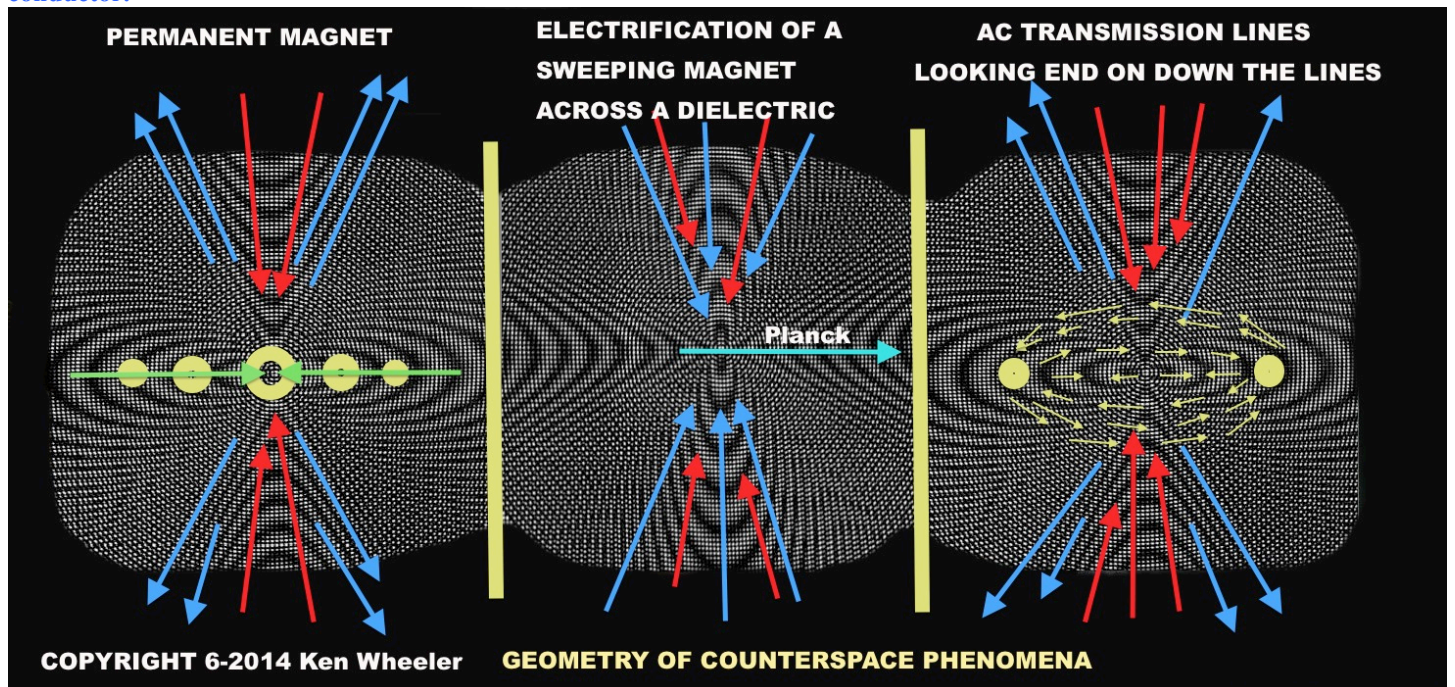

If you take a steel disk against the side of a strong magnetic block, you will notice that it’s impossible to get it to adhere in parallel. This is specifically because the nature of the steel disk is a spatial magnetic induction (not a magnet, but magnetically induced) polarization (XY axis) as against the radial centripetal dielectric. If however you attempt to stick a needle at the center of the dielectric plane of the same magnet it will touch without any effort, this is specifically due to the radial nature of the needle which is ‘pointing’ centripetally towards the gravitative-dielectric center.

Electrification requires a dielectric reflector, and any medium, which can absorb light, is a dielectric capacitor, incorrectly called an “insulator”, such as glass.

Gravitational polarization is the principle behind gyroscopic weight loss. All weight is location and medium specific. High rotational gyroscopic masses moving centrifugally as against the Ether field of gravity which is centripetal, changes both the center and geometry of mass of the gyroscopic mass in motion. The weight loss has nothing to do with torque or angular momentum.

Gravity is centripetal, gyroscopic motion is centrifugal, THIS is why the flywheel "loses weight"; weight is location specific AND medium specific. In the case of the gyroscope, its movement is counter to its field.

The insane postulation of GR that “gravitational mass was the same as inertial mass” is incorrect, inertial mass is centrifugal and motion based, whereas gravity is centripetal and dielectric in basis, as the terminator of the dielectric. The former is a motional replica of the later. Gravitation and acceleration are identical in that both are based in fields and centripetal towards an inertial plane of lowest pressure, however centrifugal inertia is motional and polarized. Polarized inertial plane torque produces electrification in the case of a dielectric reflector; likewise polarization can create the illusion of centripetal gravitation inversely by centrifugal inertial polarization of a mass.

The appearance of luminal electricity at the point of electrification from inertial plane torque is due to the breaking entering into dimensionality. This dielectric resistance, or spatial friction from two oppositional forces (dielectricity and magnetism, counterspatial and spatial, over time) is the creation of perpendicularly propagating electrification. It is not the case that dielectricity exists in reverse time, but in counter-time, conventionally meaning no time.

Below: You see modeled how the dielectric inertial plane is torqued from magnetic perturbations in electrification

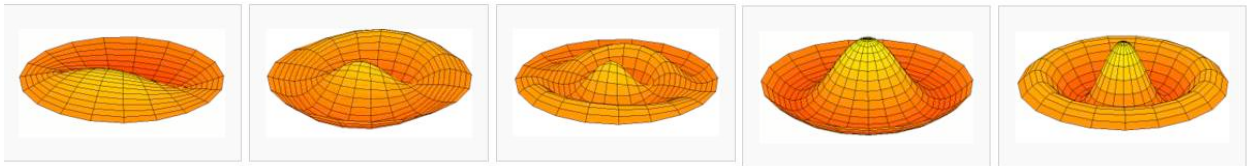

Below: Magnetic movement over time in the creation of electrification against the dielectric inertial plane in the reflector that is dielectric, i.e. the magnetic reflector.

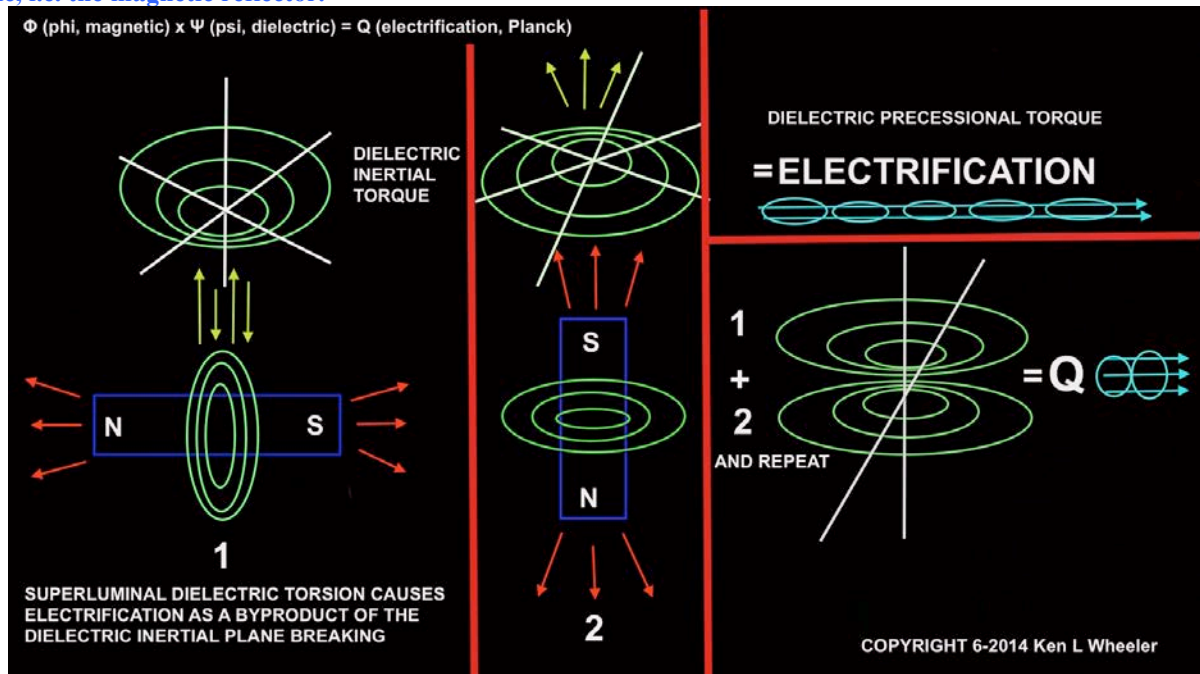

Below: In the diagrams below you can see in chain 1 thru 4, of a standard copper ring dropping at gravity against a neodymium magnetic field. At 1 there is magnetic constriction and dielectric envelopment about to occur. At frame 2, with dielectric in perfect line with dielectric (copper ring) there is conventional magnetic field geometry with an extended dielectric ring as being extended from the copper ring, which is undergoing dielectric dilation and magnetic contraction. At frame 3 there is likewise dielectric distension since, unlike frame 1 where the copper ring has yet to be mostly or fully dielectrically induced, in frame 3 there is greater resistance to escape than in frame 1 upon entering, with the copper ring well within the dielectric field of the coppers induction, as further evidenced by frame 4 where figure-8 shaped dielectric channels still exist from the magnetic XY-axis of its inertial plane down to the still-induced copper ring which is compressing the magnetic field as it passing finally thru. Figure 5 is that of a superconductive ring which is falling under gravity upon the same magnet, but at 6 has reached full immersion and is returning as if falling upon a spring, this being from the superconductor, which is a super-magnetic-reflector. It cannot sink into the magnetic field.

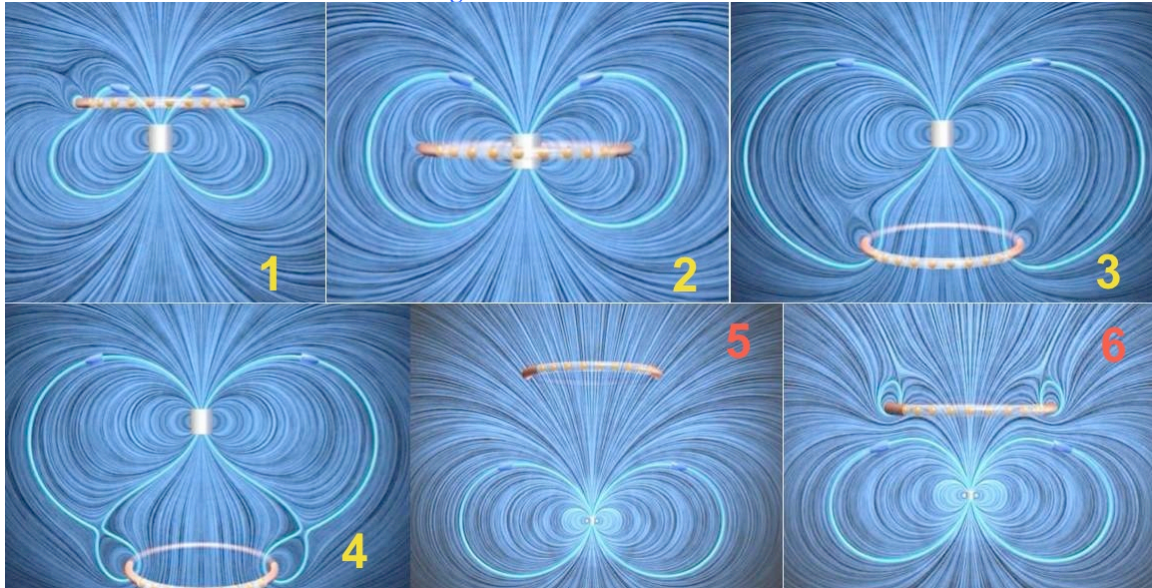

Below: Phenomena as compared between energy types. Right, the conjugate model of the permanent magnet and field incommensurability.

<i>Electrodynamic</i>	<i>Electrostatic</i>	<i>Magnetic</i>
{ Voltage or e.m.f.	Voltage or e.m.f.	Magnetomotive force
{ Voltage gradient (or electric intensity)	Voltage gradient (or electric intensity)	M.m.f. gradient (or magnetic intensity)
{ Electric current	Dielectric flux	Magnetic flux
{ Current density	Dielectric flux density	Magnetic flux density
{ Resistor	Elastor	Reluctor
{ Resistance	Elastance	Reluctance
{ Resistivity	Elastivity	Reluctivity
{ Conductor	Permittor (condenser)	Permeator
{ Conductance	Permittance (capacity)	Permeance
{ Conductivity	Permittivity (dielectric constant)	Permeability

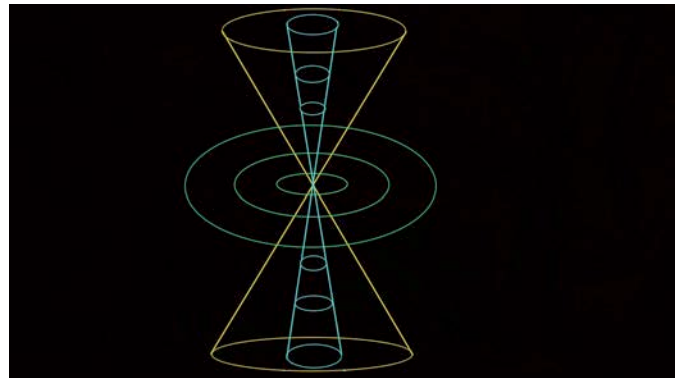

Below: Sprite phenomena created at the edge of space where the ionosphere dips down into the atmosphere and discharges some of the Earth's natural charge into the lower atmosphere. If you turn this upside down, you will see ferrofluid-like spikes. Then phenomena is not understood until now. Such phenomena cannot be understood without grasping dielectricity and the field-charge model of the universe, which has no place in the GR and QM fantasy-land of atomistic nonsense and 'discharging-particles'.

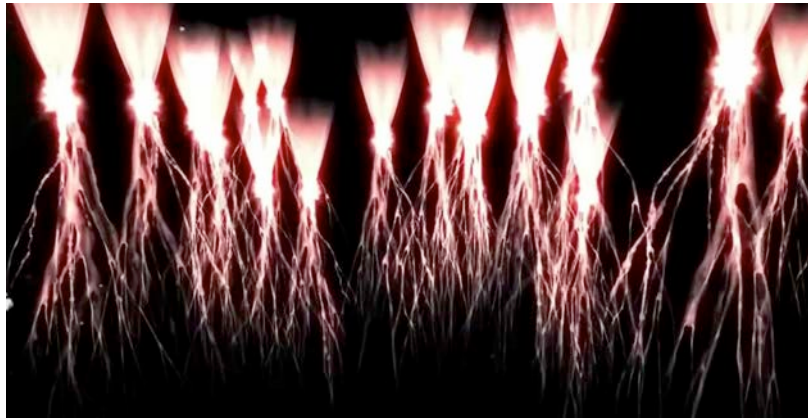

Below: Lichtenberg figures as created from high-energy dielectric saturation into Lucite, then discharged along a grounded spike

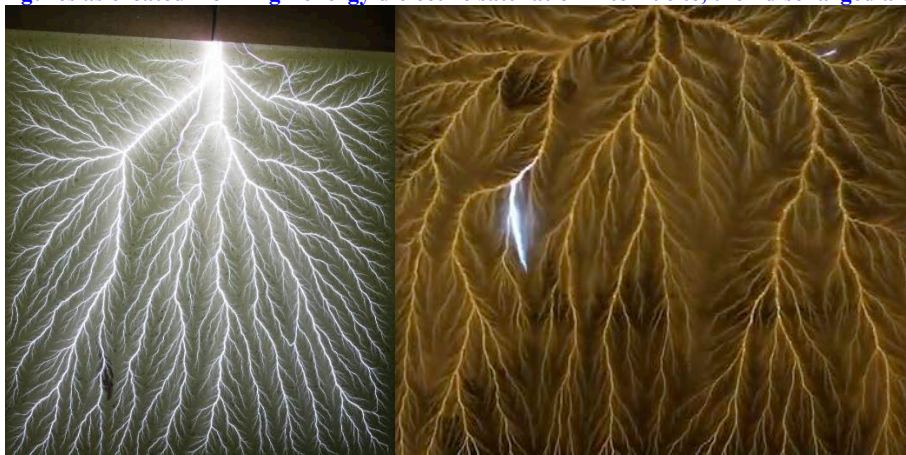

The correct architecture of the atom. The double conjugated pair model of the atom

Tesla invented much upon which the modern world operates, and helped to improve the world. Einstein invented nothing and was instrumental in the creation of the atomic bomb to destroy the world. From a very true sense, Einstein adoration and worship is literally the worship of evil and folly. - Author

"The very reason dielectric discharges, and lightning branches out in perfect golden ratio patterns is that every dielectric branch creates, spatially, a magnetically induced dominance at which point the dielectric discharges branch away from that domain at golden ratio lines." - Author

"If one were to take Relativity and Quantum Mechanics at its word, then mother nature is an insane hooker addicted to crack who created the most absurd unbelievable and irrational nonsense that would make even the imaginary friend of your child giggle loud enough for you to actually hear it." - Author

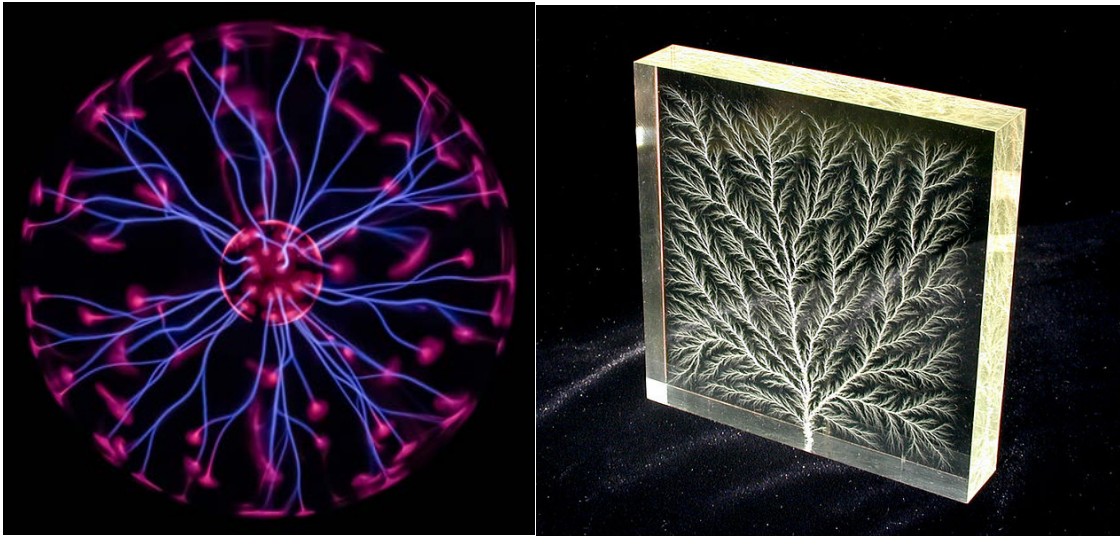

The most insane premise of all atomic models, either the debunked ‘cloud’ model or the planetary model both, is their mutual vociferous agreement that “most of an atom is 99.999999% empty space” (between the nucleus and the charged(ing) boundaries). This cannot be enjoined, logically or experimentally and is contrary to all observed phenomena and experimentation. Between the nucleus and the charging boundaries is the spatial and counterspatial ‘air’ (Ether), which, analogously, props up the highly stable (in most cases) atomic structure, that being magnetism and the dielectricity. The rotary inner vortexes inside (rather between) the atomic ‘sphere’ (complex atomic geometries actually) is a micro-turbine which induces charge, discharges, has capacitance, inductance, and has counter-to-counterspatial magnetism to prevent complete atomic dismemberment.

The atomic radius of different elements is specifically related to the magnetic-dielectric pressures within the atomic geometry. The larger noble gasses have greater internal magnetism, low dielectricity and resultantly have very low reactivity with other elements. The nucleal and the geometric charged (discharging) boundaries are atomic terminals, like a battery. Electrification affects this spatial-counterspatial geometry and likewise affects the spatial magnetism within it. Even in the ‘encapsulated balloon’ model of the atom of QM, the supposed ‘balloon’ has no ‘air’. The particle theory of atomic geometry must be summarily dismissed; it is by its very nature nothing more than rehashed Greek Atomism.

This section will be greatly expanded in further editions.

Its best to ideate the inter-atomic structure between the nucleus and its outer discharging perimeters as the magneto-dielectric plane-field, or ‘volume’, or ‘base’. Again, the notion that this inter-atomic field plane is “empty, absolutely nothing” as posited by GR and QM is a purely an insane concept and demonstrably false.

The formerly unexplainable varying atomic volumes are easily explained by the inter-atomic magneto-dielectric plane-fields, which undergo capacitance and induction pressure-gradients within the atomic geometry.

There are only two models of the universe, one based upon mathematical abstractions which created non-existent discrete particles of a myriad nature which mediate charges, fields, magnetism and electricity and have no future, no part of physics; and lastly the electrical and field model of the universe that is as simple as it is consistent, logical, rational and explains all phenomena in the universe with simplicity, not complexity. There is only one mass-particle, and all fields are as per the Ether. All else is a misunderstanding of time-space versors, charge-discharge false dualities, and spin polarities.

Nothing in the entire universe could exist if the proton-neutron-electron model of the universe were accurate. Erase from your mind forever the false conception that atoms are made up of spinning charged beads, this planetary model of the atom is a psychosis. The inter-atomic ‘space’ of the atom is completely filled with magnetism and dielectricity. The necessary unexplained and endless phenomena of elements and compounds is fully explained by the electro-conductor-magneto-dielectric model of the atom. Counterspatial-spatial-spatial-counterspatial (discharge-plane, charging nucleus, inter-atomic-magnetic, inter-atomic counterspatial dielectric respectively). This **double-conjugate pair** is the last remaining missing puzzle to be finally brought forward about the atomic structure of the atom for the first time ever, and lastly for all, explains unexpected phenomena, reactivity, electrification, conductivity, permittivity, and susceptibility. In simple, the electro-discharge and magneto-dielectric induction and capacitance.

Electrification, in short, terminates in the inter-atomic structure thereby creating a macro-magnetic field; this is the final degenerative/radiative stop for the electrical charge. In the creation of electricity and in the nature of the atom there are but four real factors, two spatial, and two counterspatial. Dielectricity and the discharge plane in counterspace; finally the magnetic and charged nucleus (‘conductor’) in space. In electrification, the discharge plane is the electrical (so-called ‘electron’), the superluminal spinning

charged nucleus is the conductor, the dielectric is the radial counterspatial versor of the Ether between the magnetic and the conductor, as found in the atomic model as the inter-atomic dielectric ‘volume’, and the magnetic, however in the case of the magnet the field itself is in motion, not the magnet unless otherwise impelled to do so. The two unreal factors in electrification are time and space, which are abstractions and spatial vectors in the creation of electricity. So we have magnetism, dielectricity, electrification, nucleal gravity, the discharge plane, and the conductor, lastly remaining in electrical production are time and space.

Since the nucleus and the geometrically charged (discharging) boundaries are atomic terminals, like a battery, electrification in the creation of a magnet is discharged into the inter-atomic dielectric, such that the dielectric field terminates on conductors, in this case the nucleus and the nucleal discharge plane (‘electron field’), which thereby causes inter-atomic contraction and macro-magnetic ‘expulsion’. The displacement current or dielectric induction is resultant from the ferrous electrification. The magnetic field always self-terminates and the dielectric begins and ends on the charging and discharging terminals.

Just as electricity flows in the space between the wires, the ferrous electrification in the creation of a magnet flows between the atomic terminals of the nucleus and the discharge plane within the inter-atomic magneto-dielectric field planes, the presumed, but utterly wrong, “massive empty space of the atomic model” as hatched from the insane minds of GR and QM.

All atomic operations are the same as the macro world of electrical theory. Atoms are a balance of electricity/charge (as mediated by the nucleus) and kept in balance by the interspatial dielectric and the inter-atomic spatial magnetic. There are however no electrons, this fundamental error carries on today. Induction, charge, capacitance are all mediated by the Ether from the atomic field pressures all the way to high voltage power lines. This correct model of the atom solves the never-answered conundrum as to why (non-existent) electrons don’t spiral into to the nucleus, or in this case charge disappears in the nucleus. Charge is mono-binary, or an extended one, just as polarity in a magnet is a perceptual abstraction of spatially inverse spin. In which case the atomic model can be reduced purely to charge-discharge and magneto-dielectric all of which keep in place atomic electro-diamagnetic equilibrium in check, except in instances of Magneto-Isotopes where alteration is possible. Ferro-atomic dielectric saturation occurs at the point of electrification wherein which the charged atomic geometry is forced to expel magnetism from its magneto-atomic field-planes.

The magneto-dielectric-charge of the atom has a sponge-inside-a-balloon model as the nature of the atom. Analogously the tiny sponge inside the balloon is the superluminally moving charging nucleus which can be saturated or discharged from electrical induction (or as an isotope), likewise the ‘air’ inside the balloon being the conjugate equilibrium forces of counterspatial dielectricity and spatial magnetism. The skin being the electrical charge (no electrons needed, a foolish notion which must be eventually dismissed and long ago dismissed by Heaviside, Tesla and others) which both can be dielectrically charged-discharged and of which the balloon can be squeezed and distorted to create macro-magnetic phenomena (atomic orbital geometries) as in the case of a ferrous mass; as would be analogous to letting out an unending supply of ‘air’ (Ether) out of the balloon resulted from electrical saturation and dielectric expulsion of the magnetism.

The planetary model of the atom is nonsense, and has long ago since been disproven. The Schrodinger / Born ‘cloud’ model of the atom is likewise nonsensical and cannot account for the magneto-dielectric pressure gradients witnessed from atomic charge, discharges, and phenomena manifest from extreme cold and heat. The only correct model of the atom which is representative of experimentation, logic and consistency is the magneto-dielectric gravitational sponge inside balloon model of the atom. The supposed “strong nuclear force” is in fact of course merely the stable dielectric which has terminated into the creation of mass and resultantly the creation of centripetal gravity fields. Mass creation is the ‘negative terminal’ for the creation of mass from dielectricity, just as magnetism is the ‘negative terminal’ of terminating electrification.

Below: Defunct models of atomic geometry still taught in colleges and elsewhere. All completely atomistic, materialistic by nature. The correct atom is purely magneto-dielectric, gravitational and entirely full of magneto-dielectricity in its volume. The nonsensical premise of GR and QM that the atom is 99.9999999% empty is purely farcical, as established by Tesla and others.

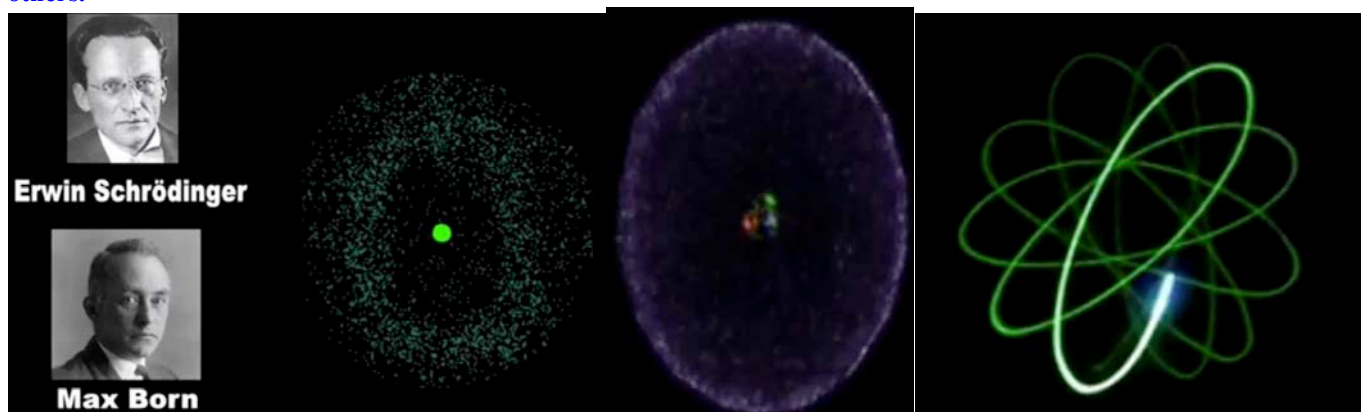

Magneto-isotopic is the more correct analogous manner of speaking of elemental magnetization as regards permanent Ferro-magnetism. Electrical susceptibility of the ferrous material to hold a dielectric charge, its magneto-dielectric 'elasticity', and become dielectrically capacitant and macro-magnetically altered is specific to certain materials and composites which should designate a different class of nucleal-isotopes. Not ones based upon proton or neutron count and nucleal radioactivity but magneto-dielectric structure making the same elements a specific subset of elemental magneto-isotopes. Logically there must be two variants of isotopes designated to any element. Nucleal-isotopics and magneto-isotopics. All isotopes are connotatively out of ideal equilibrium, in either the nucleus or in charge and respective magneto-dielectric geometries.

The very premise of classifying another state of matter, plasma, is in this arena of reclassification, which of course is merely just ionized gas of a unique charge. Plasma is just a dielectrically charged filament which conducts dielectricity in a similar manner to conventional conductors, however since Plasma is the most abundant elemental form in the universe, our metal conductors are in fact the 'unconventional conductors'. Plasma, same as a permanent magnet, is just disequilibrium of the magneto-dielectrics of its system, either stable or unstable with a unique phenomena characteristic to its uniquely charged or discharging (both) state. Either states involve dominances of dielectrically higher capacitance, or dominances of higher magnetic induction.

Protons are magnetically dominant particles since their superluminal velocity within the nucleal structure mediate out electrification and discharge (again, no electrons) in the atomic system. This system of discharge is from the superluminal nucleus creating charge in its movement against the inter-atomic dielectric inertial planes, which is the source for the entire fallacy of GR and QM that there are "fields of electrons" and the long ago debunked "shells of electrons". This is patently absurd and Tesla and his kinsmen knew this fact. This array of superluminal protons (or one in the case of hydrogen) are inducing electrification within and against the dielectric atomic volume with likewise resultant spatial reactions inside the interatomic as mediated by magnetism within that volume.

One can think of the nucleus as the superluminal prime mover of an electrification system which is also the charging inducer causing inter-atomic magneto-dielectrical atomic geometries to form. All mass particles (protons and neutrons) are the stable convergences of terminating dielectricity; however protons are magnetically induced particles and neutrons are dielectrically capacitant particles. This is why helium has a much smaller atomic radius than does hydrogen, which contains no neutrons.

The notion that neutrons are converted into protons via "beta decay" and protons into neutrons by "inverse beta decay" is an absurdity. Neutrons convert into protons from dielectric (electrostatic) discharge from excessive magnetic self-induction (so-called beta decay) and protons become neutrons by excess electric discharge, or as meant depolarization, and increased dielectric capacitance which all mass particles are by nature, the stable convergence of terminating dielectricity. Protons and neutrons are both the only particles in any atom, and both are one and the same particle wrongly differentiated as wholly unique, but only from the perspective of their respective induction or capacitance.

The cult of quantum states: "Protons are known to transform into neutrons through the process of electron capture (also called inverse beta decay). Neutrons can convert back to protons through beta decay, a common form of radioactive decay." However this is all patently false. The correction is that protons transform into neutrons by way of dielectric capacitance (there are no electrons), and neutrons can convert back into protons by means of a net loss of dielectric charge and therefore once again become magnetically induced (but this magnetic induction is merely about the particle, not within it, just like a conventional magnet) either in the atomic system or in total atomic ejection these same neutrons become protons because their superluminal particle geometries (not their ejection speeds) cause magnetic self-induction polarized dominance, and conversion or re-conversion into a proton.

Neutrons are the generative particle and protons are the result of electrical charge polarization (in the making) terminating about and coincident to the neutron to create a proton which is polarized and the creator of, in its superluminal nucleal platform as atomic dynamo, the charging 'prime mover' polarization particle of the atomic system. However as is the case the free 'neutron' (rather mass particle) is naturally magnetically induced and the premise for and of the hydrogen atom, the most prolific element in the cosmos. As is typical, humans see the proton, as the 'positive' (not just in the sense of creating charges) particle, and the neutron as the do-nothing 'neutral' particle. However the case is just the opposite, the neutron is the first fundamental mass element, and the proton is the necessitated conjugate dominant particle in the universe (ala hydrogen) due to this fundamental mass element (the 'neutron') being immediately self-induced magnetically as a solitary particle and therefore the genesis of hydrogen. Just as a DC transmission line creates a magnetic dominance around the electrical transmission, so too does the fundamental mass particle create its own induced magnetic attribute, thereby creating the proton, and hence hydrogen.

As even GR and QM know, a neutron exists for very little time in the free universe before immediately becoming a proton, this time lapse is the building up of magnetic-induction of the dielectrically dominant neutron in rapidly becoming a polarized and charging system (in itself) proton. The only logical possibility to have a charging system, a power generator with a single mass particle, the proton, as elemental hydrogen, is by having this fundamental mass particle having a dominant magnetic induction about itself and its magneto-dielectric totality in nature is the genesis of the hydrogen system. The most elemental and simplex dynamo in the cosmos.

The reason hydrogen, the most abundant element in the universe, is merely a single proton (likewise the smallest dynamo that exists) then becomes extremely obvious. The magnetically induced and dominant proton operating as a superluminal dynamo creates an atomic volume of dielectricity with resultant electrification or charge to maintain its homeostasis. Dielectricity literally creates charge,

or dielectricity by using a mass particle (dielectric in nature, its stable terminus) and its coincidental induced magnetism over space and time to create more dielectricity. For one to create one (itself creating more of itself) dielectricity uses the mass particle magnetically induced over a rate of polarization-over-time to create more of itself. A likewise relationship exists in magnetism to create additional magnetism. This is the conjugate nature of the cosmos.

There is only one particle in the universe, the mass-particle, with two modal attributes of existence. QM explanation of neutron to proton conversion is a pathetic farce, is nonsensical in the extreme. There is “beta decay”, there are no electrons. The universe is divinely simple in its makeup.

The inter-atomic plane, or volume between discharge (‘electron field’) and the nucleus is purely magneto-dielectric in nature and necessarily is how and where electrification causes inter-atomic contraction. The inter-atomic spaces (as meant the Ether), contrary to current conception, are in fact not an insulator at all.

Electrification causes inter-atomic convergence of the dielectric into the counterspatial, and conjugate divergence of the magnetic which circulates around the magnet. The movement of this magnetic field over time against a reflector which is dielectric, is electrification.

The CNAP (convoluted nonsense and poppycock) of P-orbitals, atomic orbitals, has nothing to do with non-existent electrons rather with geometric (see diagram) representations of magneto-dielectrical geometric discharging barriers which conform geometrically to the nucleal mass particles (either magnetically induced protons or dielectrically capacitant /dominant neutrons).

Dielectric reflectors are the best ‘conductors’ such that their dielectrically charged over-abundance of excess neutrons in the nucleuses act to form the expulsion of electricity in creation from a rotating magnetic field. Such as silver, copper, gold, and platinum.

The dielectrically predominant nature of iron and its specific atomic geometry allows iron to be the most ideal element to undergo magneto-dielectric ‘elasticity’ and produce macro-magnetic phenomena. Bismuth for example is so extremely diamagnetic due to its over-abundance of excess neutrons (83 protons vs. 126 neutrons) in the nucleus and its atomic geometry.

Hydrogen’s atomic radius is 53pm versus that of helium’s 31pm, while containing 3 more mass particles, helium has a much smaller atomic radius due to neutron dielectric counterspatial contraction which hydrogen lacks completely with its predominant magnetic atomic volume from one proton. These models only apply to certain elements, but is aptly demonstrated in the most simplex elements where complex proton, neutron and magneto-dielectric forces convolute the geometry of larger elements beyond the point of simplex demonstration. Even oxygen has a smaller atomic radius than that of Hydrogen, with a diameter of 48pm.

The presumed ‘discharging plane’ of the correct atomic model derives its discharging planes (wrongly and popularly ‘electron orbitals’) from the respective spatial and counterspatial nature of the inter-atomic magnetism and dielectricity respectively, which interact with the superluminal rotating nucleus to create inter-atomic pressure gradients of discharge which irrational science wrongly conceives of as “electron orbitals”

Below: Defunct models of atomic geometry. The bead model, the wave model, and additionally the ‘cloud’ model. By reifying the non-existent electron as a bead, a wave function, and a ‘cloud’, quantum has made its nonsense unfalsifiable by declaring the non-existent electron (really the discharging plane from the inter-atomic magneto-dielectric volume) is bead, wave, and a cloud. This type of hyperbolic insanity cannot be enjoined.

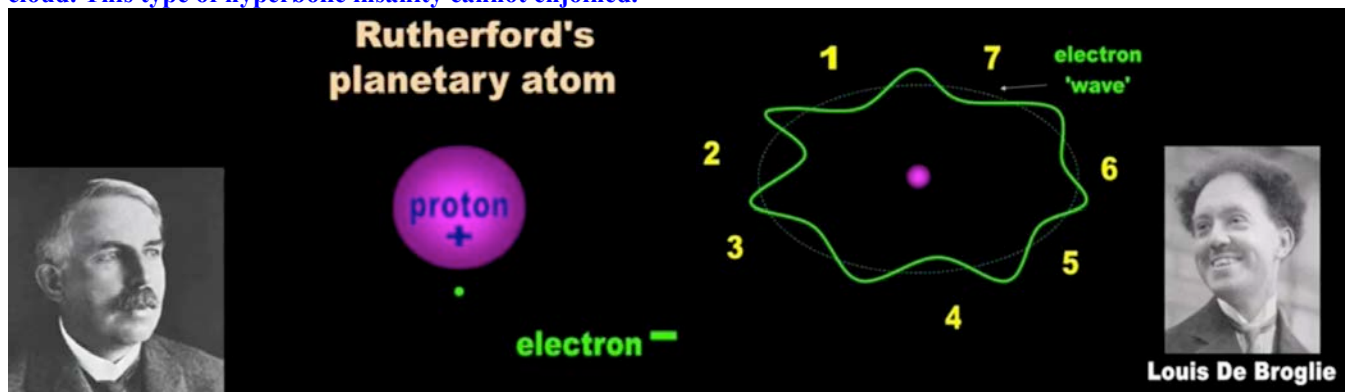

There are only two forms of particle radiation, alpha and neutron radiation. Beta, gamma, and X-ray radiations are dielectro-electromagnetic emissions from magneto-dielectrically unstable elements, they are not particle based. The dielectrically charged over-abundance of excess neutrons in some elements such as Uranium and Plutonium are neutron radiators specifically due to the fact that dielectricity is counterspatial and neutrons are spatially charged particles with dielectric counterspatial capacitance. Given this fact the spatial-counterspatial ‘struggle’ in the inter-atomic volume forces neutrons to radiate.

In ultimate reduction, even the discharging plane of the correct atomic model is merely a stepped and conjugated discharge as mediated by and thru the magneto-dielectric inter-atomic geometry. In which case all atomic models are accurately the tripartite interplay between the charged mass particles, either neutron or proton (dielectric or magnetic in dominance) and their encapsulating magneto-dielectric volumes which mediate spatial and counterspatial charges and discharges as well as form the charging boundaries of all atoms to form molecules and all other compounds.

The “strong interaction” or “strong nuclear force” is merely the immense counterspatial bounding power of dielectricity which binds protons and neutrons into and as a stable mass particles, and the same forces between protons and neutrons which hold them together in the nucleus. Convoluted explanations of GR and QM are fantastical and irrational.

Below: The defunct model of atomic geometry, and inset bottom right is the correct way in which chemists illustrate covalent bonding daily to explain molecular bonding.

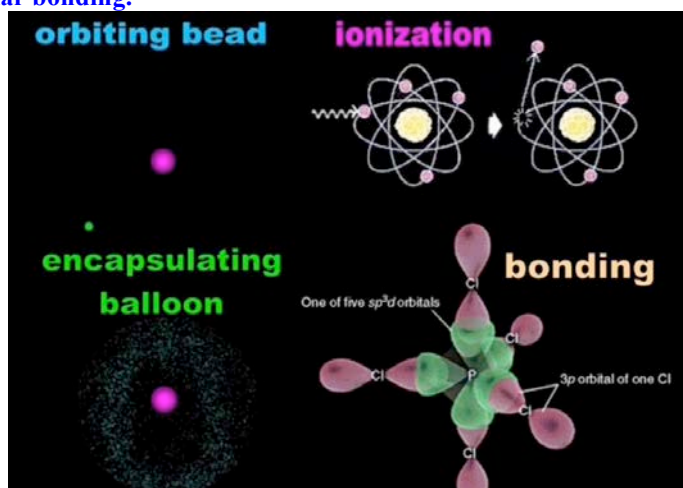

Below: Rough diagrams of atomic magneto-dielectric volume 1, 2, and 4. Middle row 3 is the process of electrification in creation of a permanent magnet. 5 and 6 showing polarization voidance spheres of decreasing spatial, increasing counterspatial acceleration, the first of two magnets coming together, the bottom right showing the dielectric inertial plane.

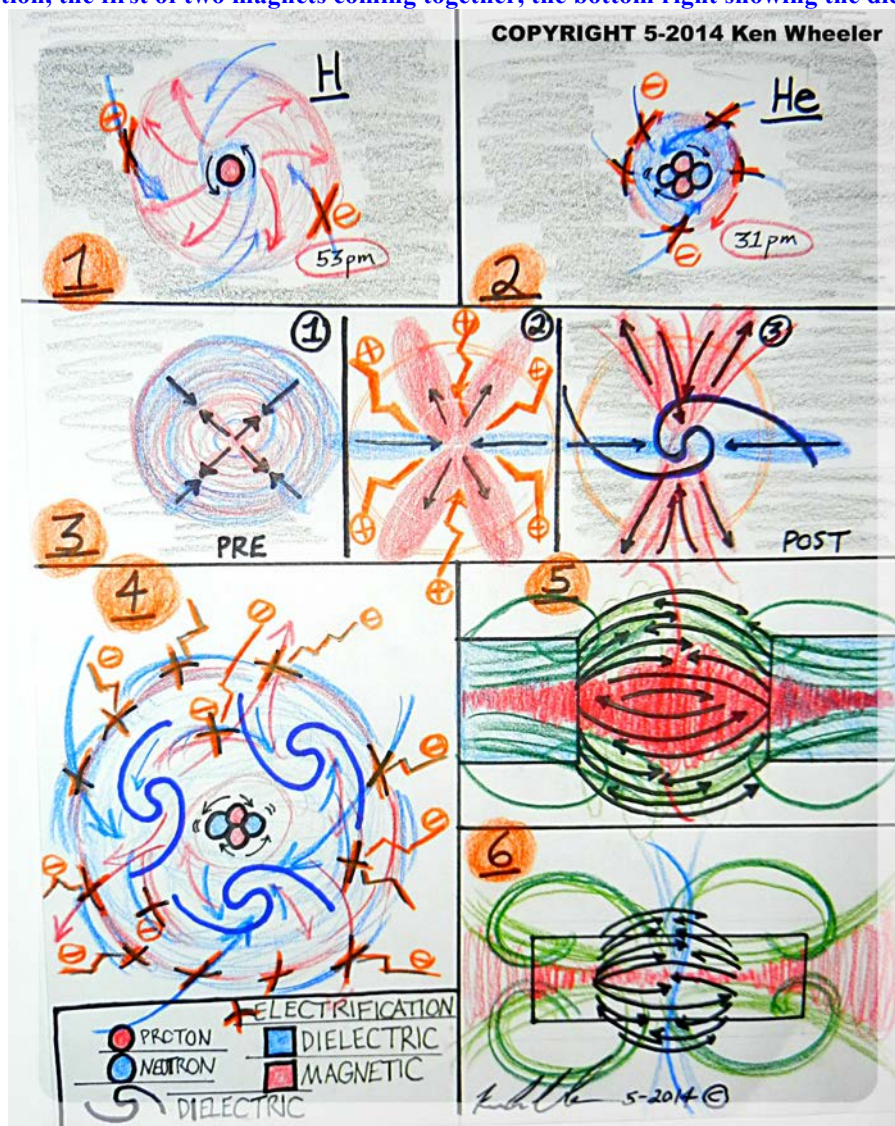

Atomic orbitals geometry as logically explained by magneto-dielectric inter-atomic volume

Maxwell's discovery of a factor of proportionality between dielectricity and magnetism led to his theory of conjugate pair of inductions, dielectric and magnetic, in union, propagating at the velocity of light through the "Luminiferous Aether". Hence, electro-magnetic waves in free space, unbounded by gross physical matter, mass free energy. This propagation is within the dielectric, or aetheric, medium itself. It is free of so-called "charge carriers" (electrons), a mass-less form of electricity. This concept had a very powerful impact upon the scientific and philosophical thoughts of Maxwell's era. So here begins the notion of "wireless", the transmission of electricity without wires or other guiding structures. Leading up to the work of Heinrich Hertz, 1857 to 1894, the wireless transmission of electricity had found experimental verification by Joseph Henry, and Elihu Thompson. It even was patented by M. Loomis. These examples however were not electro-magnetic, they were electro-static (dielectric). Heinrich Hertz provided the first complete laboratory demonstration of the transmission of electricity through "free space", (across the room). This was instantly considered proof of the Maxwell theory of electro-magnetism, and electro-magnetic waves. When Nikola Tesla engaged in the experiments of Hertz, he found these waves not to be completely electromagnetic. The early death of Hertz prevented any further progress. However "the world view" kept hold of its belief that "Hertzian" waves are only transverse E. M. waves, the two distinctions now synonymous. – Eric P. Dollard

Since we know electrons are not particles, but a misunderstanding of magneto-dielectric fields in motion, we can examine atomic orbital geometry with perfect lucid clarity. Chemists use the balloon model of the atom everyday to explain covalent bonding in the formation of molecules, which is exactly correct! However what is not understood is that these dumbbell and disk configurations are

magnetic (dumbbell formations) and dielectric (disk areas of inertial planes) dominances (moving counter to each other) as driven by the gravitational (strong nuclear force comprising stable dielectric wave bundles of inertia), protons (magnetically charged) and neutrons (dielectrically dominant).

Using what we have proven about magnetism moving spatially away from dielectricity in hyperbolas (inverse sphere), and dielectricity being a centripetal radial counterspatial inertial plane, all atomic orbitals can be understood with demonstrable lucid understanding even to a young person.

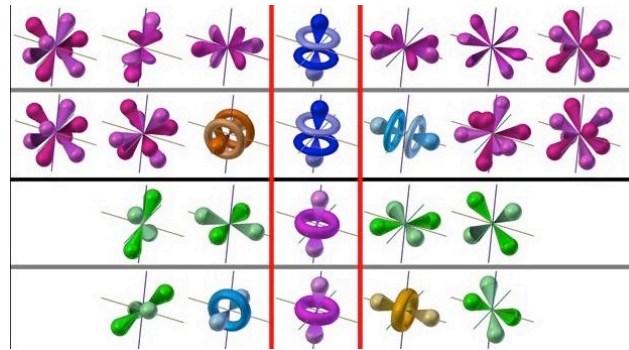

Below: On the left we have different planes of the magnetic and dielectric, middle magnetic dominances from proton movement production of magnetism, and right typical explanations of chemical ionic bonding from attractively charged particles which meet at electro-geometric point of low pressure.

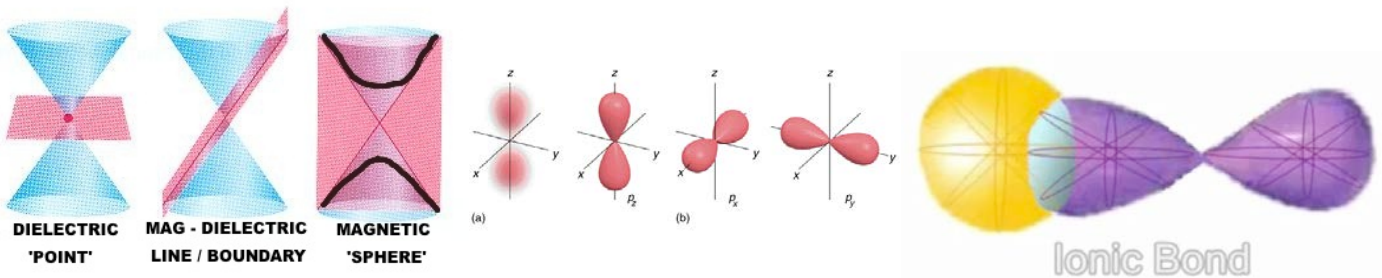

Below: On the left we have complex magnetic meeting points with corresponding dielectric repulsion saddles, middle we have left-side archaic incorrect model of the atom and right-side the correct way atoms are treated daily by chemistry to show the basis of covalent bonding, however these orbitals are not electron 'clouds' or other nonsense, but protonic magnetic dominances interwoven between dielectric inertial planes which creates a conjugate pair of forces which is the correct atomic model, explains charge, discharge, and bonding in molecules. On the far right we have a pair of proton-sourced magnetic spatial dominances between which exists but is not illustrated, dielectric planes.

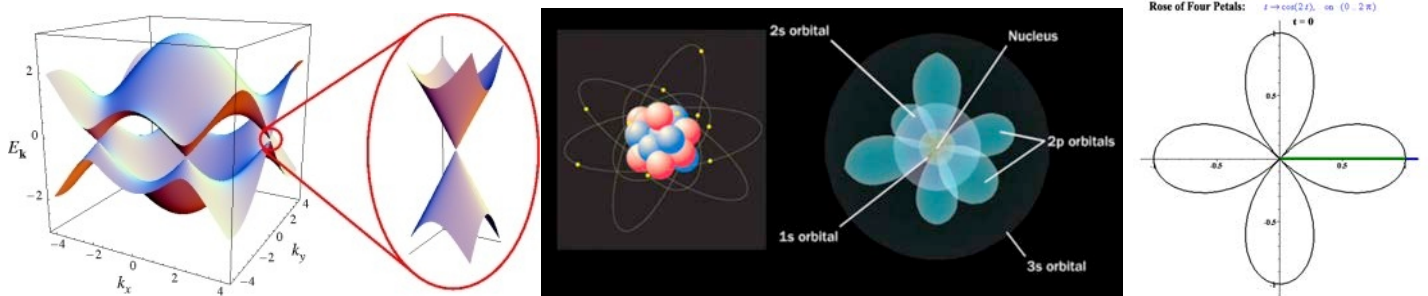

Below: On the left, more magnetic configurations, at bottom right of same you can see the dielectric inertial plane, same as a found in a conventional “magnet”. On the right illustration you can see some of the complex magneto-dielectric geometries atoms can take depending on charge, temperature, nuclear orientations etc.

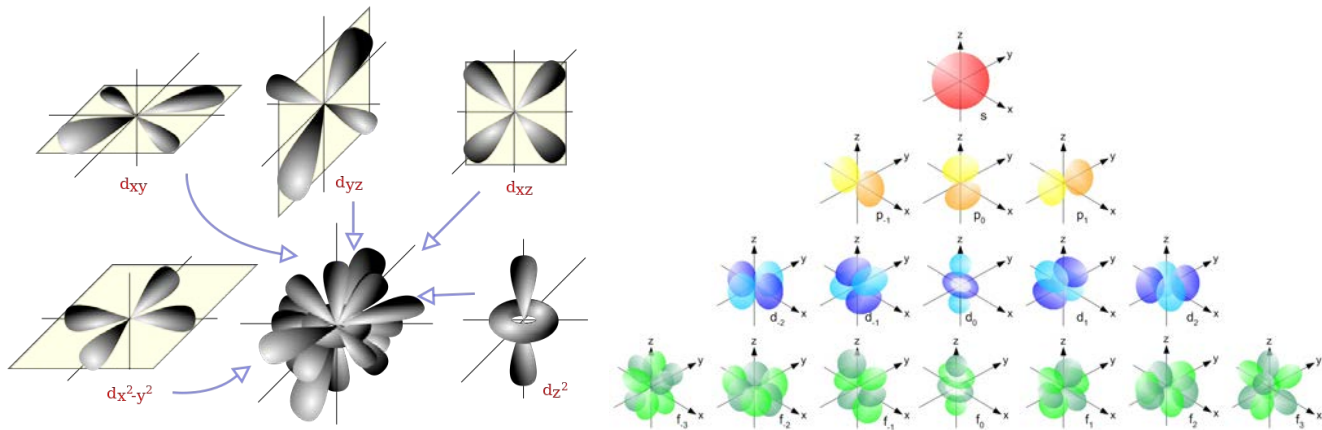

Below: On the left and right you can see that molecules come together at lowest pressure and charge points, either dielectrically or magnetically and in complex, always both. Understanding this divinely simplex fact explains atomic architecture, covalent bonding as used by chemists every day, and utterly debunks the notion of a swarming nest of “0 rest-mass” so-called “electrons” which cannot in any way, explain the atomic and molecular bonding of atoms. The very premise that the atom (as espoused by GR and QM) is “99.99999999% empty space, nothing” is an outright insane absurdity. If one wishes to call dielectricity and magnetism not-a-thing (‘nothing’) so be it, however there is “air” in the atomic ‘balloon’, and that air is a conjugate pair of dielectric and magnetic fields generated by the nuclear dynamos generating and changing them at every millisecond and faster.

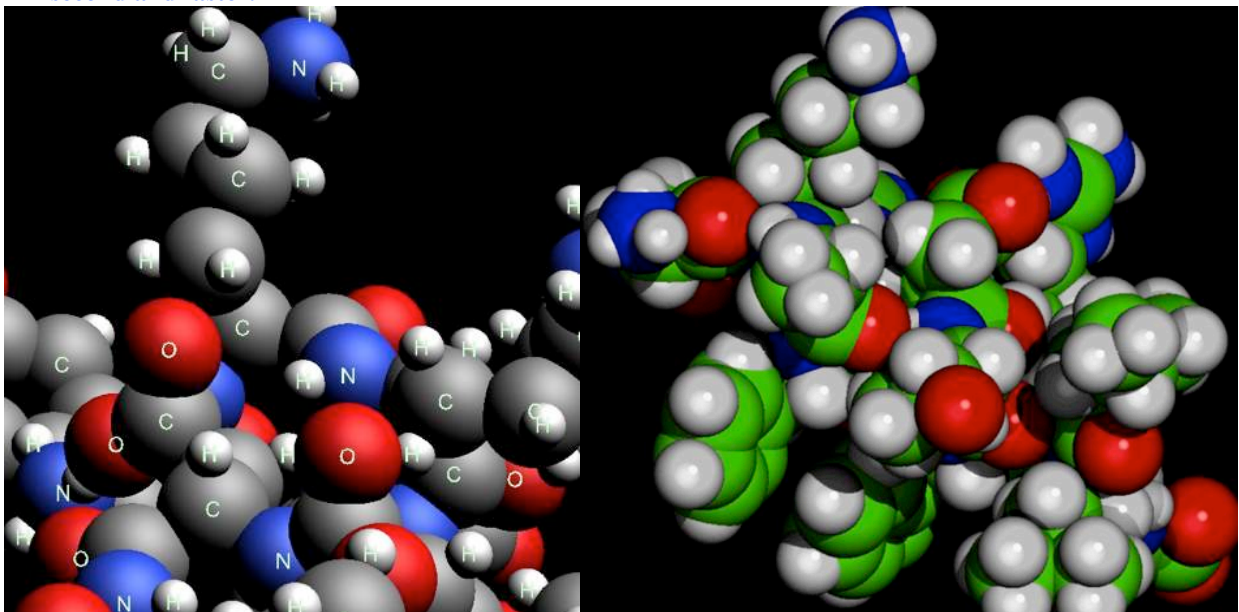

Atomic orbitals: Lets look at the nonsense from GR and QM in black, and correct it in the blue

It was found that the orbiting electrons around a nucleus could not be fully described as particles, but needed to be explained by the wave-particle duality. In this sense, the electrons have the following properties:

(What this really means is that enormous evidence against the electron-bead model of the atom forced another quantum “Alice in Wonderland” answer from the cult of quantum to explain atomic geometry, this time as “wave particle duality” absurdity.)

Wave-like properties:

1. The electrons do not orbit the nucleus in the sense of a planet orbiting the sun, but instead exist as standing waves. The lowest possible energy an electron can take is therefore analogous to the fundamental frequency of a wave on a string. Higher energy states are then similar to harmonics of the fundamental frequency.

(What this really means is that the so-called ‘electron’ is a magneto-dielectric field whose wave/undulatory mechanics are dependent upon the nuclear makeup)

2. The electrons are never in a single point location, although the probability of interacting with the electron at a single point can be found from the wave function of the electron.

(What this really means is there is no such thing as an electron outright, it has no point, no locus, therefore cannot be a particle, and yet the magnetic and dielectric interactions can be explained by wave functions.)

Particle-like properties:

1. There is always an integer number of electrons orbiting the nucleus.

(This is purely conjecture and speculation)

2. Electrons jump between orbitals in a particle-like fashion. For example, if a single photon strikes the electrons, only a single electron changes states in response to the photon.

(This is purely conjecture and speculation, what this means is if another dielectric outside charge strikes the atom its charge state geometry changes in response to the change in charge, creating an imbalance in the inter-atomic magneto-dielectric volume)

3. The electrons retain particle like-properties such as: each wave state has the same electrical charge as the electron particle. Each wave state has a single discrete spin (spin up or spin down).

(This is nonsense, even under the heading of particles, they cannot escape the fact that the so-called electron has no particle-nature, no reality as such)

Thus, despite the obvious analogy to planets revolving around the Sun, electrons cannot be described simply as solid particles.

(Here there is agreement, electrons do not exist, and they're an abstraction of the functions of discharging boundary 'points' incorrectly deemed "discharge particles")

In addition, atomic orbitals do not closely resemble a planet's elliptical path in ordinary atoms. A more accurate analogy might be that of a large and often oddly shaped "atmosphere" (the electron)

(Here there is agreement again! The discharging field, which they are calling an 'atmosphere' is merely a function of spatial charge transferences)

distributed around a relatively tiny planet (the atomic nucleus). Atomic orbitals exactly describe the shape of this "atmosphere" only when a single electron is present in an atom.

(Meaning there is no hope of this particle nonsense being explained for most atoms which contain, as they postulate "enormous numbers of electrons", such as lead, plutonium, etc. Once again they use the term "atmosphere" to describe a field, magnetic and dielectric. This "cloud" model of the atom is not fundamentally different than the solar model of the atom. Purely absurd and illogical)

When more electrons are added to a single atom, the additional electrons tend to more evenly fill in a volume of space around the nucleus so that the resulting collection (sometimes termed the atom's "electron cloud") tends toward a generally spherical zone of probability describing where the atom's electrons will be found.

(This is purely conjecture and speculation of the highest order)

Fundamentally, an atomic orbital is a one-electron wave function, even though most electrons do not exist in one-electron atoms, and so the one-electron view is an approximation

(Meaning the only nonsense that can be diagramed is the hydrogen atom, not the 99% of the rest of the elements.)

The vibrations of an electron, is an idealized circular drum head—essentially an elastic membrane of uniform thickness attached to a rigid circular frame.

(Meaning dielectric inertial plane torque, of the dielectric field in the interatomic. Now they explain charge-discharge or a supposed particle with that of a drum head. There are no discreet particles in the universe, all is mediated by fields, charges, discharges, and centripetal-centrifugal movements in the spatial magnetic, and counterspatial dielectric cosmos).

Galactic jets as magnetic and electrified magneto-dielectric models

"The very small is mirrored in the very large in nature, this is always the case" – ancient saying

"Experiment without theory is tinkering. Theory without experiment is mysticism, is quantum nonsense." – Author

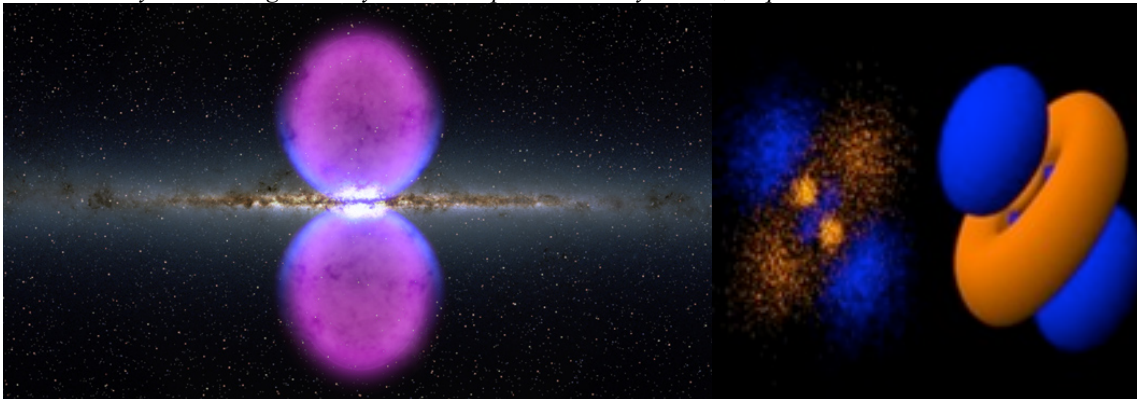

“The great mystery, now understood, is that while magnetism and dielectricity move 180 degrees from each other, in binding closed systems where gravity is immense, either in galactic structures, or in nuclear structures, the disk-dumbbell formations of dielectricity and magnetism move (only apparently) 90 degrees from each other in the special geometric formations of a disk and a pair of inverse double hyperbolas, since the structure is of course binding and contractive, this is the lowest pressure model of magneto-dielectric mutual repulsion. How do two opposite forces that are “tied” together in a system (inter-atomic, galactic, permanent magnet) move 180 degrees from each other when one is spatial and polarized, and the other is radial and counterspatial, the answer is an inertial plane accretion disk and a double hyperbola. What appears as perpendicular movement is in fact maximum repulsion in a binding system.” – Author

“Science wrongly thinks that since iron is endothermic, that this is why a supernova occurs, because stars cannot burn iron, and once iron is produced, the star tears itself apart, of which the later part is true. However as we know iron is the most stable element, iron is supra-dielectric, it is capable of enormous amounts of electrical saturation (which is needed to create a magnet), and capable of enormous amounts of magnetic induction, or saturation. Literally an ‘electrical sponge’. We wrongly think copper and silver are the ‘electrical sponges’ since they’re used in power feed lines, when in fact, of course, they are dielectric reflectors as Heaviside, Maxwell, Steinmetz, and Tesla declared them. We have it backwards.” - Author

Importantly I must state that discovering the identical bell-disk, or double-hyperbola-disk nature of galactic jets came after the fact of discovery of same from experimentation with magnetism, I did not model magnetism upon the this galactic architectures. Pure discovery and insight into recognizing this special spatial-hyperbola conjugate relationship as seen in galactic formations came later, and proved the timeless adage that “in the very small you can see the very big, and vice-versa”.

Imagine a “magnet” (a dielectric object with resultant magnetic spatial Z-axis phenomena), except a trillion trillion times larger and equally more powerful. As predicted by myself and circumstantially so by a few others, such a perfect-point intersection is the creation of matter itself, wrongly called a black hole, and completely refuted by Stephen J Crothers. The dielectric accretion disk is creating new matter that is flowing centrifugally outwards along the hyperbolic conical vortex of the galactic jets. Gravito-magnetism as conceived of by the fool Einstein does not exist, however the effect is real and is driven by a dielectro-gravimetric field which is – TIME and –SPACE (counterspatial). This is specifically a dielectric inertial effect of spinning electrical giant masses which generate enormous dielectric inertial planes and axially form matter generation.

Galactic jets are extremely powerful jets of charged matter and gas, or plasma which emerges from presumed massive objects at the centers of some active galaxies, notably radio galaxies and quasars. Their lengths can reach several thousand or even hundreds of thousands of light years, literally many trillions of miles in very tight magnetic vortex formations; quite literally a multi-trillion mile needle of newly generated matter and plasma. The reality is that the magnetic fields in the accretion disk collimates the outflow along the rotation axis of the central point where the dielectric and magnetic forces are strongest and, of course, self-repulsing, so that when conditions are suitable, a jet will emerge from each face of the accretion disk. If the jet is oriented along the line of sight to Earth, relativistic beaming will change its apparent brightness. The mechanics behind both the creation of the jets and the composition of the jets is perfectly understood upon knowing the conjugate relationship, the geometry, and model of magneto-dielectricity. How they move, reciprocate, and how one affects the other. Logically so, studies of these galactic jets, or the birthing of matter itself from intense magneto-dielectric forces, have recently proved the obvious, that these jets contain matter.

In ignorance it has been stated that: “Ever since the first observations of these powerful jets, which are among the brightest objects seen in the universe, astronomers have wondered what causes the particles to accelerate to such great speeds.”. Obviously so these multi-trillion mile magnetic jets are the necessitated repulsion from the accretion disk which is electrical in nature, specifically natures natural electricity, dielectricity. The distorted galactic jets do not form typical permanent magnet reciprocating spheres because the accretion disk is so utterly massive and powerful, however the golden ratio symmetry is still preserved. The distorted magnetic field lines pull charged particles off the disk and cause them to gush outward at nearly the speed of light.

The intersection points between the dielectric and the magnetic creates a special spherical volume where no induction can occur, no light can propagate, there is no medium to “soak into”, this rare geometry is a special counterspace where the Ether has been completely displaced. The fools of GR and QM call this a “black hole”, but its definition and parameter all fail and have been disproved already in full. This special geometry, unlike normal Ether-counterspace, is utterly devoid of medium and field induction or propagation, electricity and light can enter where no reaction can occur. This special counterspace geometry is found at the center of every “magnet” but of insufficient power for anything of the immense magnitudes of galactic magneto-dielectric intersections where matter is generated and expelled, in the jets of plasma.

This special geometry is the one and only true ‘void’, since Ether itself has been displaced, and ironically is the very same locus of new matter generation at the immediate apex point of super-powerful magnetic centrifugal vortexes along the circumferential points of the sphere where the dielectric and magnetic meet and (very hard to visualize but extremely simple) the magnetic field forces the super powerful dielectric charges to form new ionized elements, hydrogen and possibly helium as well. Quite literally a galactic ‘navel’ where the birth of new matter occurs. How archetypal of the ancient mythos which said the very same thing; how extremely prophetic, ironic, and amazingly accurate.

Below: On the right showing the perfect golden ratio distribution (cross section) of the galactic systems. Notice how the stronger the centripetal accretion disk is, the flatter, and likewise so too the magnetic jet, notice likewise on the far right the more powerful the magnetic in scope, the greater the dielectric, or accretion disk displacement is.

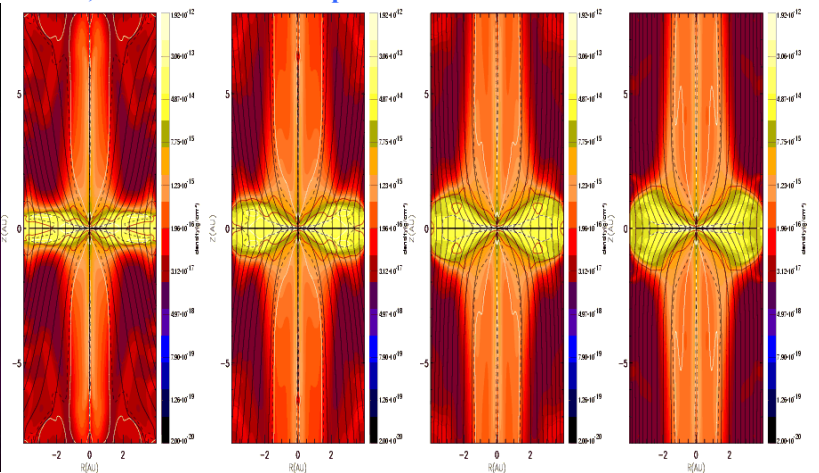
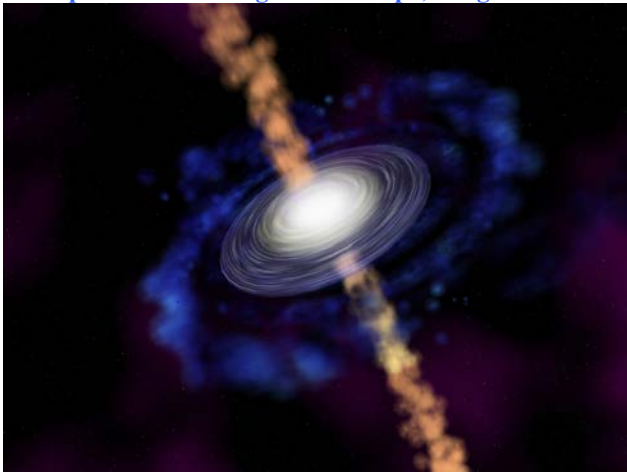

Below: Showing the tightly bound magnetic jets that are highly constricted due to the accretional power which confines their geometry to Φ^{-3} instead of $1/\Phi$.

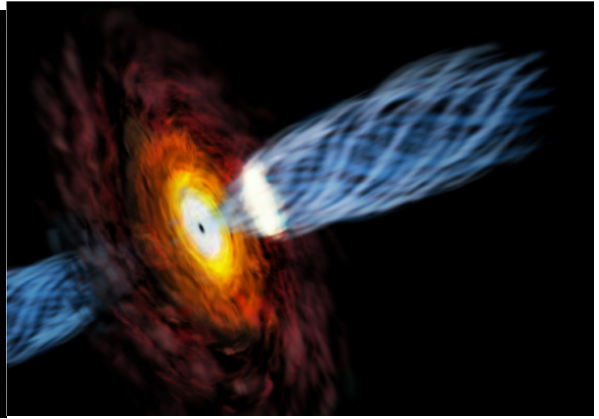
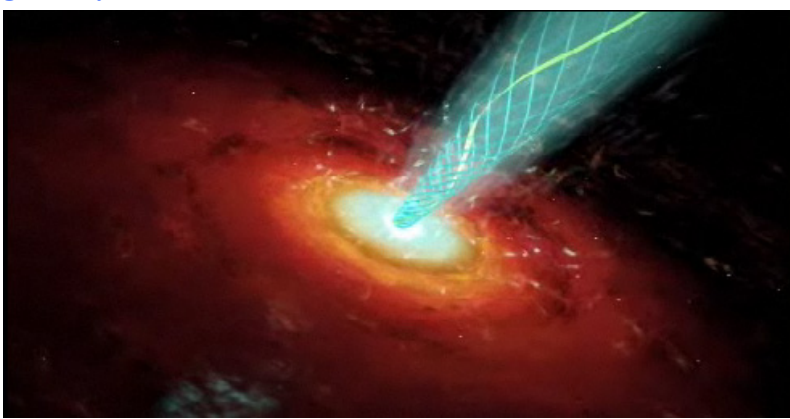

Below: Showing the toroidal accretion disks of these galactic giants and their magnetic jets drawing matter out and away for the generation of newly forming system in the distant future.

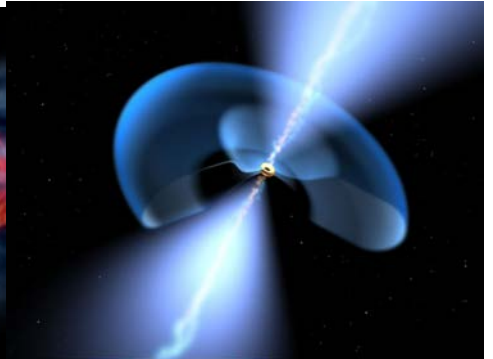

Below: Showing the centripetal charging and galactic jets on the left. On the right, importantly, showing the precessional magnetic jets in a galactic system that exactly mirror gyroscopic precession either dielectrically, or in a natural gyroscope. Notice the double hyperbola dumbbell shaped magnetic spatial dominances. This is a perfect representation of a permanent magnet and illustrates both precessional torque along the inertial plane, which in the case of electrification, and is necessary for electrical generation.

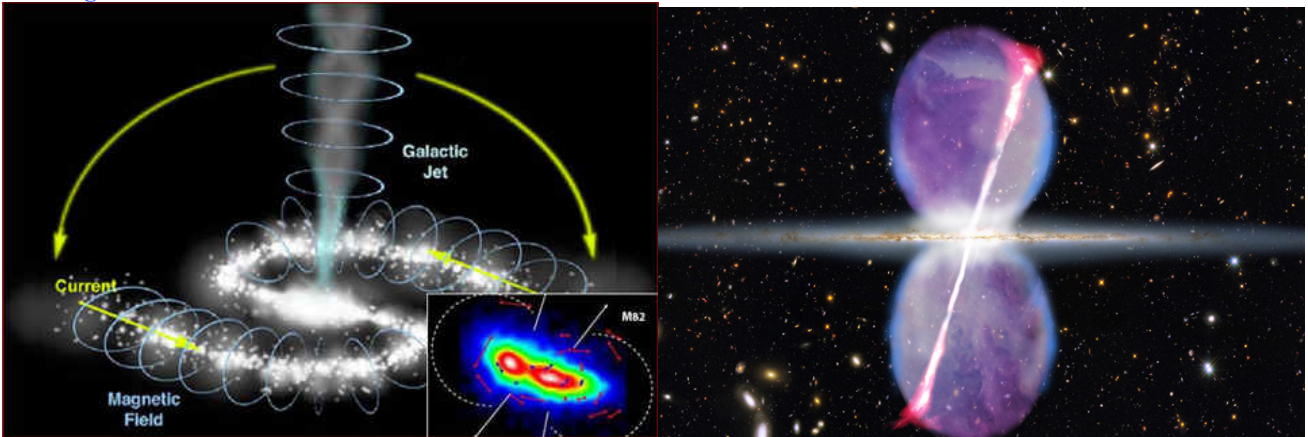

Below: Showing centripetal flow in the galactic system which is delivering centripetal charge flow to the center of the system and conjugate outflow of magnetism carrying along the new matter from creation, both radiating out into the cosmos.

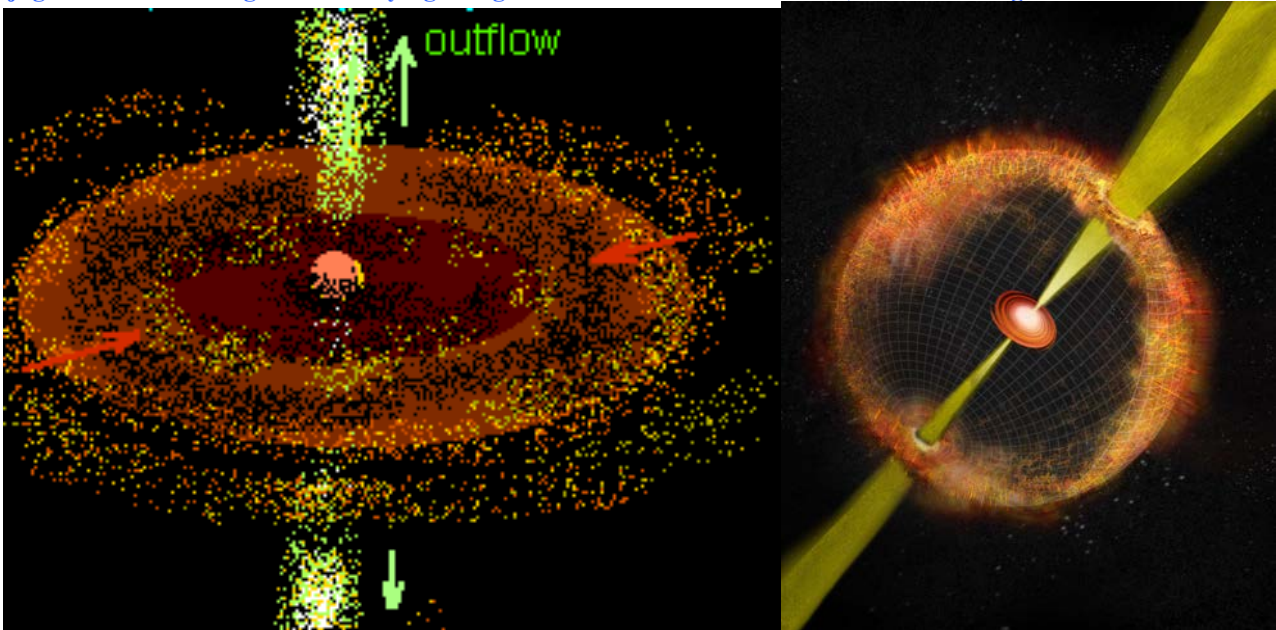

Below: On the left depictions of the ‘corkscrew’ centrifugal magnetic flow (the centripetal is not shown and greatly distorted due to the immense power of these binding systems), on the right, new matter having been generated extending in tight jets many multiple trillions of miles from their source of generation.

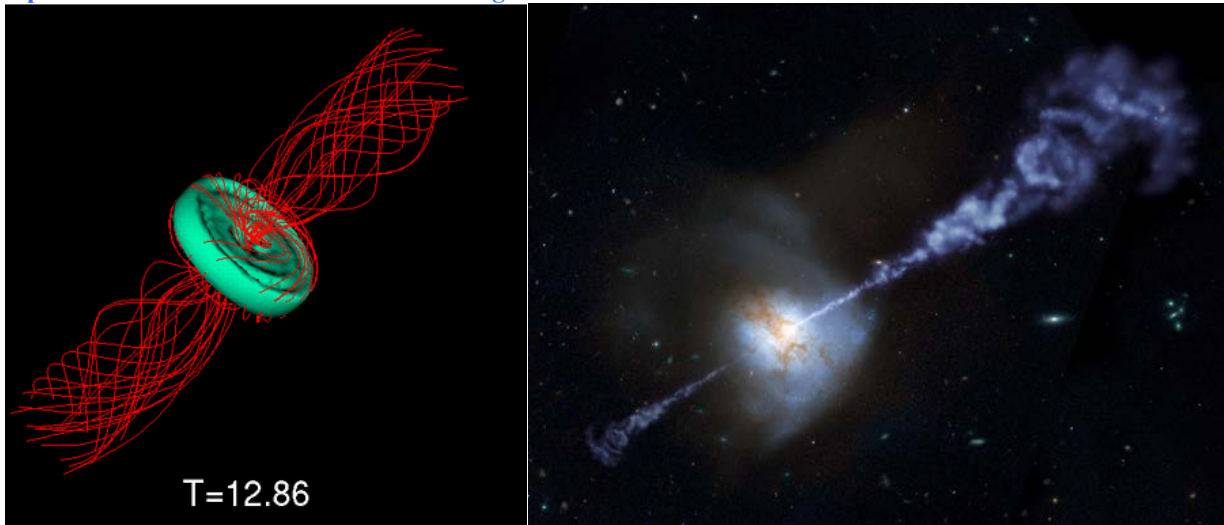

Below: Other depictions of the dielectric-magnetic disk-bell/double-hyperbola geometry. The only manner in which two diametrically opposed objects can exist in a binding system (from gravity, in a binding electrified mass, or “magnet”) is in this special geometry, rather natural least-resistance geometry.

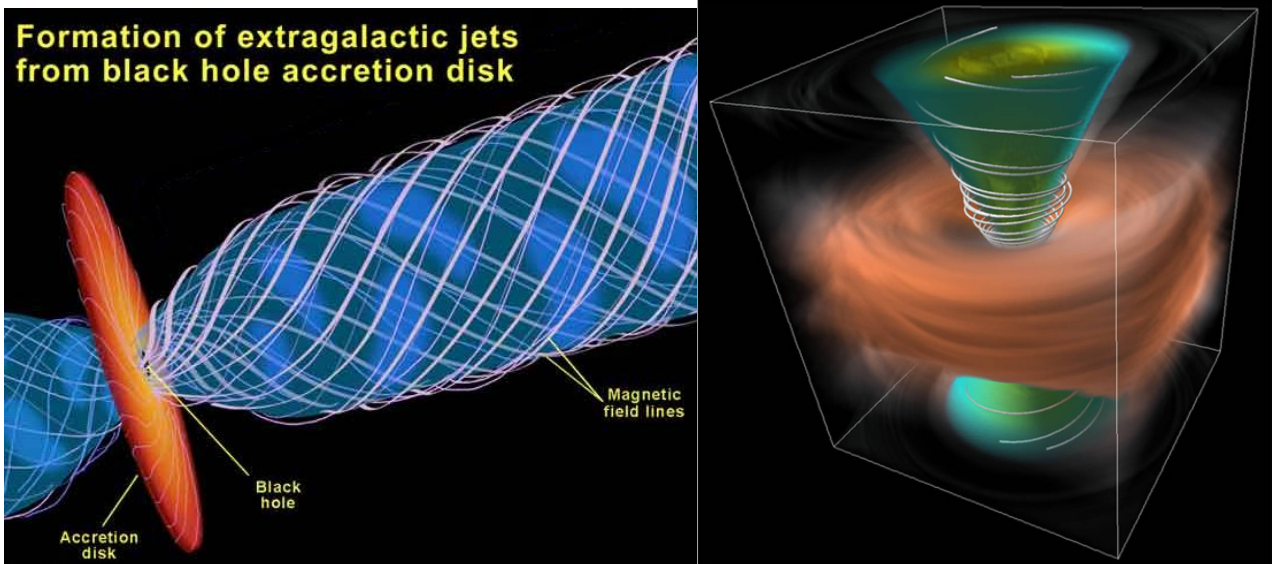

Below: Other than the inaccurate depictions of a black hole (a non-existent object disproven by Crothers and others) at the center of the inertial plane and magnetic apex centrifugal jets, these depictions are accurate, both to the model of magnetism in a permanent magnet and to the dielectric inertial plane. However given the immense power of these systems, the Ether which is compressible, the magnetic jets are likewise compressed in geometry, however still at golden ratio polarization.

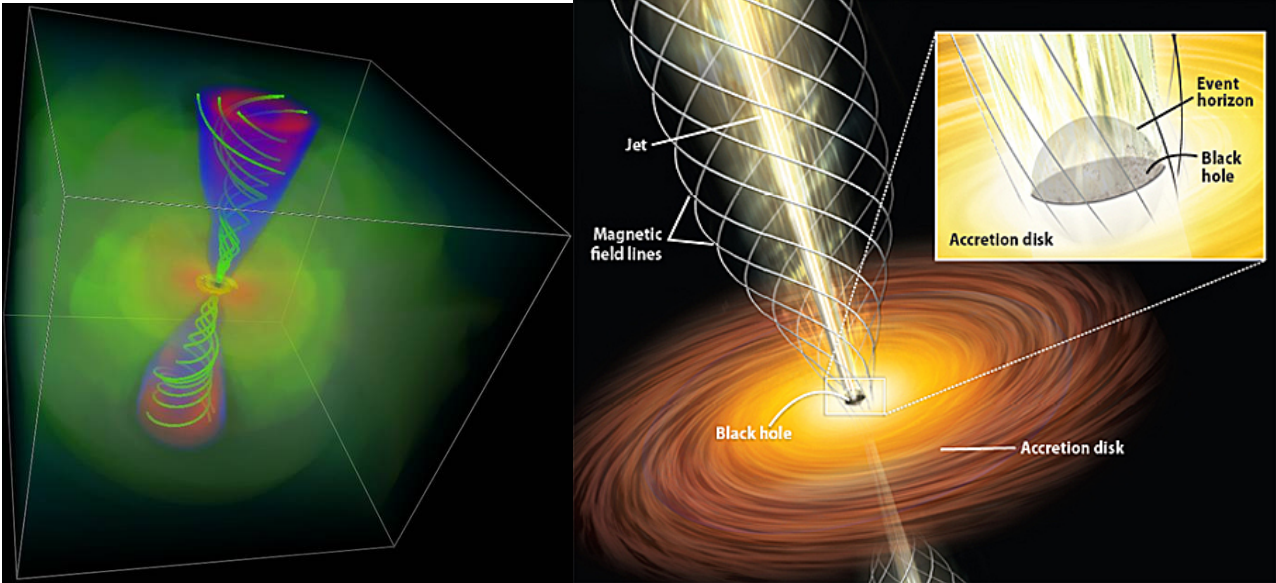

Below: Supernova 1987a, with magnetic bells, and dielectric “lynchpin” disk at the center. Obviously dominantly magnetic, because at the end of life, stars have created so much iron, they cannot ‘burn’ iron. Iron means magnetism, magnetism means spatial displacement, meaning supernova. Iron is the boundary element where fusion ends and radiation, or explosion begins. Even all scientists agree on this point. Its not that iron kills stars, which it does, but rather the magnetic saturation attributes of iron tear apart a star like a central explosion from magnetic spatially radiative dilation. Stars are electrical, are centripetal in their field, until they produce iron, at which time, they explode, like magnetism which is a radiative termination, and become centrifugally-initiated (due to iron production) stellar ‘bombs’ which tear themselves apart.

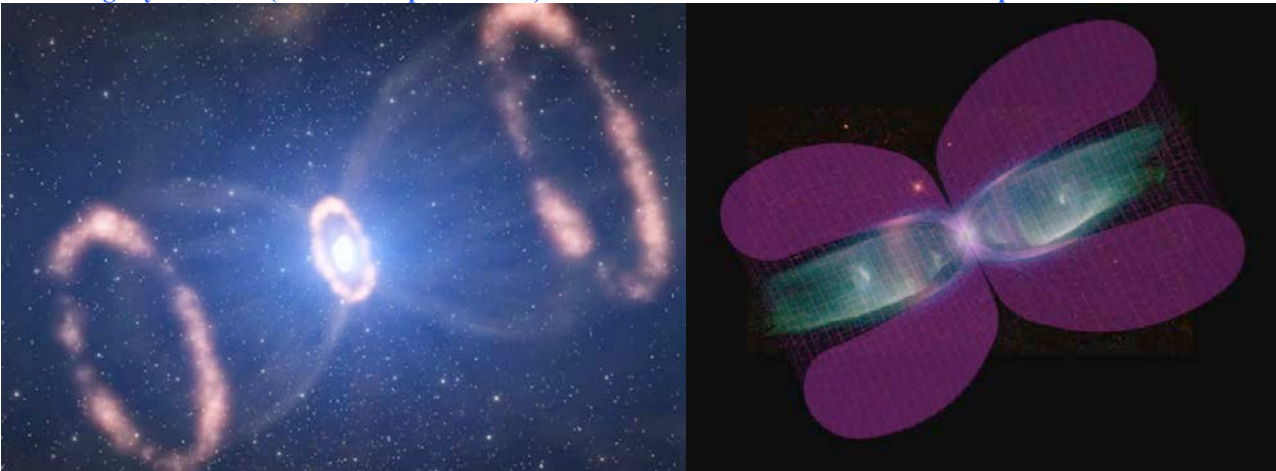

Below: More galactic phenomena showing the double-hyperbola magnetic 'bell' formations

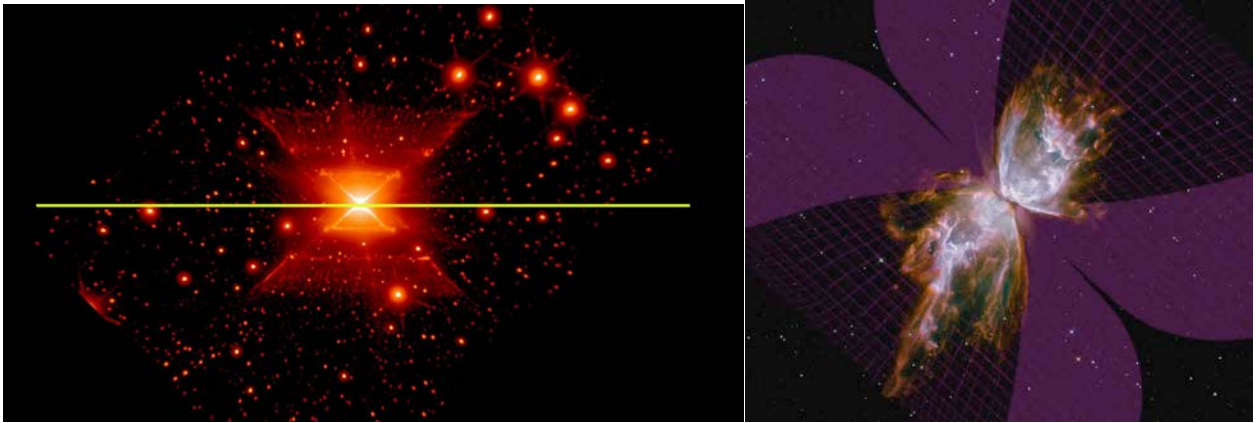

Below: HH30 galactic jet spewing out newly formed matter over trillions of miles in a tight magnetic jet. On the right, the double hyperbola formation of magnetism emanating from our own galaxy as represented in this illustration. The galactic plane of 'old matter' is the charging accretion plane of new matter creation as expelled along the magnetic double-bell formations.

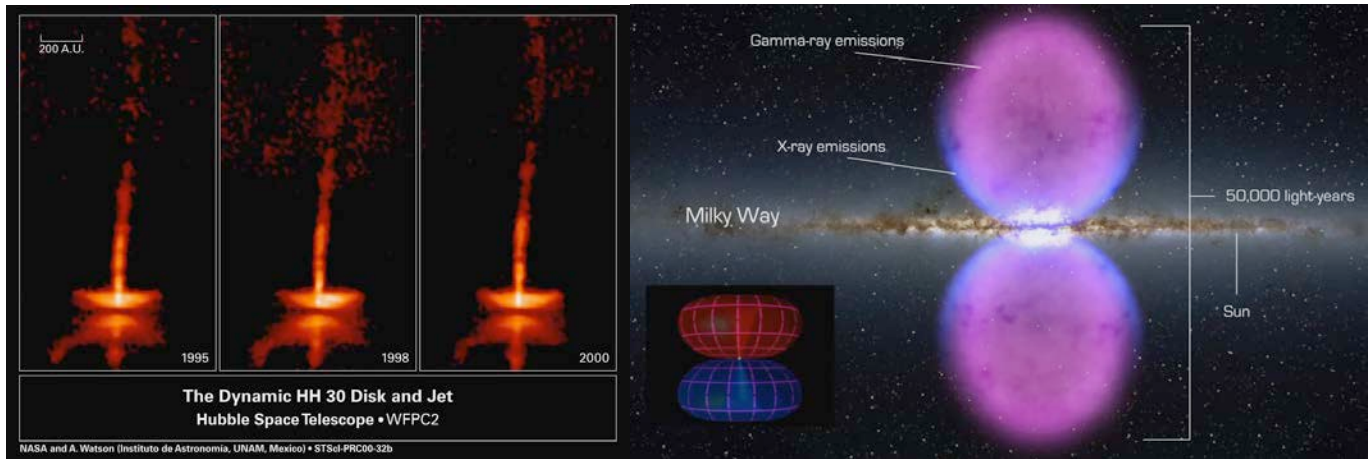

Light's missing secret, or, electromagnetism is not purely (or mostly) electromagnetic at all

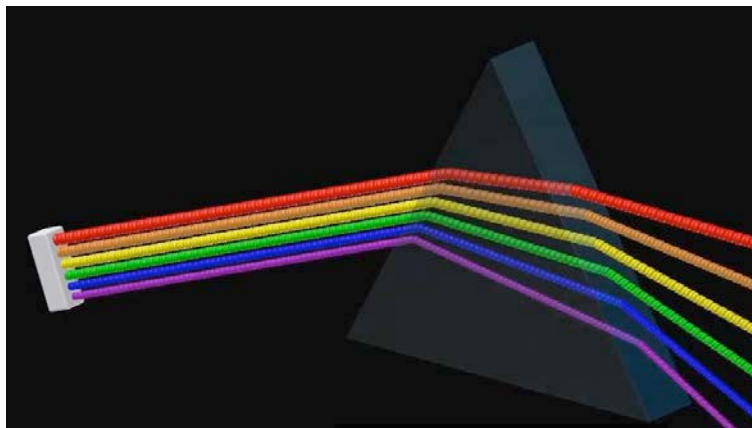

The very principle of the 'photon', same as the 'electron' is pure rubbish. The false reification of light as "self-inductive" E and M components cannot exist, and is not the nature of light or electromagnetism in general. The co-axial nature of light at which EM conjugates thru the dielectric carrier is the correct geometry of 'electromagnetism'.

The incorrect notion from the cult of Quantum is that: "photons of a light beam have a characteristic energy proportional to the frequency of the light". The truth of the matter however is that the radial 'internal' component of dielectric energy as comprising the correct model and geometry of light is proportional to the high frequency, or shorter wavelength of the EM.

The nonsense of the “wave packet” and the photon is the misunderstanding of the dielectric energy carried proportional to the frequency of the bounding electromagnetic with its internal and co-axial radial charge-carrying conductor, the dielectric. The electric and magnetic components are merely byproducts of the dielectro-electromagnetic geometry incorrectly thought of as (merely) electromagnetic in nature.

BELOW: On the left are the incorrect conventional misunderstandings of TEM. Center the circular polarization along the Z-axis of the radial dielectric. Right is the coaxial cable as invented by O. Heaviside who understood the coaxial nature of EM propagation, but apparently didn't understand that there was a third component to TEM.

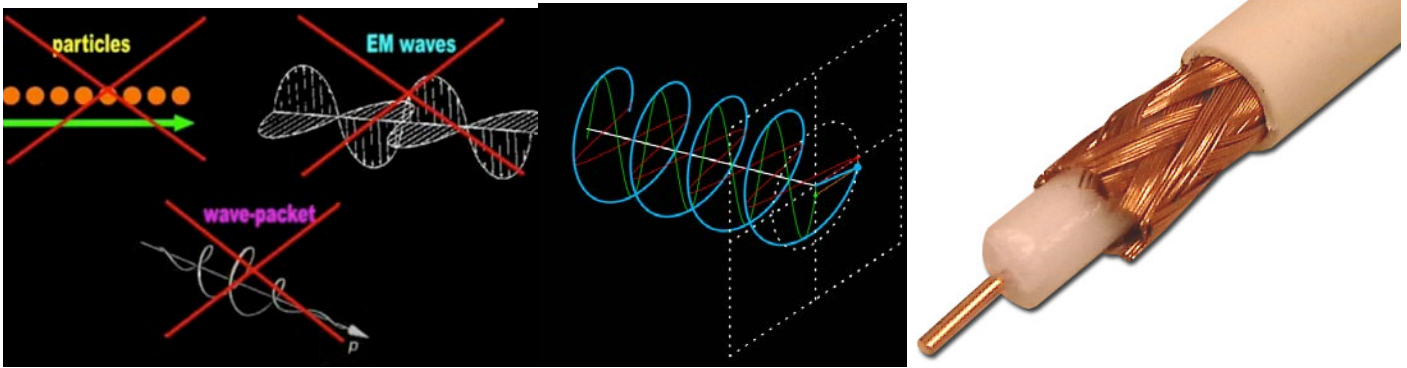

That light has 2 modes of reciprocation and three components is specifically the basis of the “wave-particle duality” (in reality an electromagnetic and dielectric radial-dimensional co-axial geometry) as wrongly propounded by GR and Quantum. Two transverse E and M polarizations with dimensionality and a dielectric radial component, which is the electromagnetic-fulcrum upon which electricity and magnetism conjugate thru and against.

The nonsense of “wave-particle duality” from Quantum mysticism is a fallacy; light creates interference fringes due to constructive or destructive phasing from the dielectric additive or destructive polarization, or “light on light”.

While magnetism is geometric and spatial, electricity and dielectricity are counterspatial (however the electrical component is polarized). The quasi-matter of E.M. has the dielectric as the counterspatial Z-axis or ray around which electricity and magnetism reciprocate thru mutual induction and capacitance upon and rebounding against the dielectric. There are no photons, this inducto-capacitance electro-magnetic form, or E.M. accounts for the misunderstanding of wave-particle ‘duality’ (rather sheer ignorance) and countless other unique attributes of T.E.M.

BELOW: The correct geometry of TEM, dielectro-electromagnetism with its Z-axis radial component. Discovery 4-2014

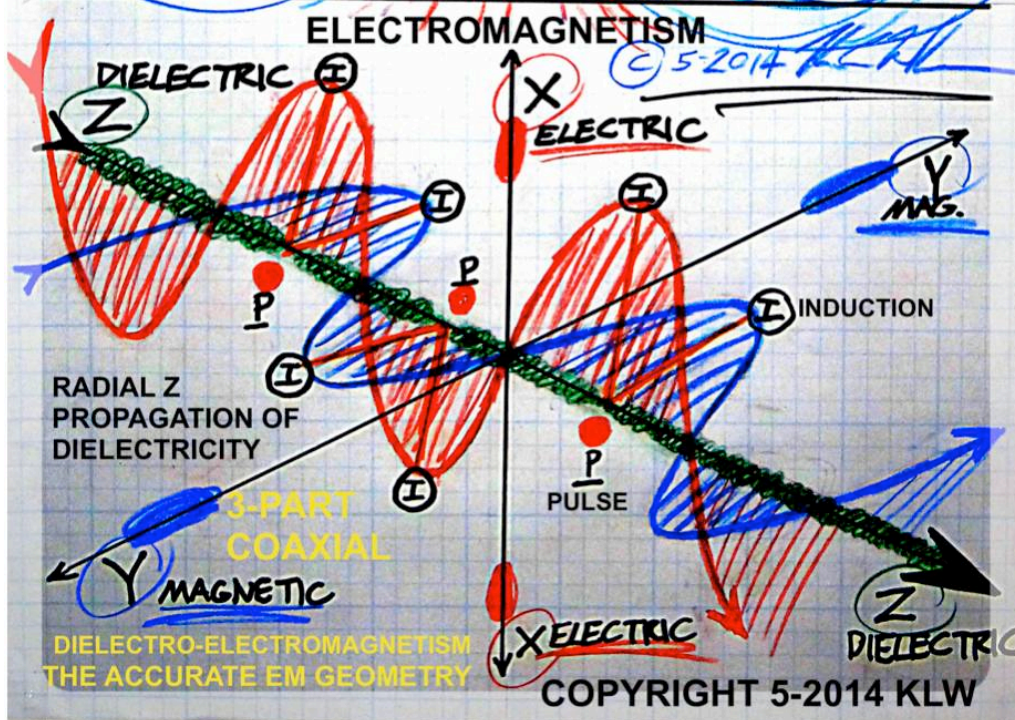

Light is not a material emanation or projection, rather sheer induction containing 2 axial and 1 radial components. By true definition, the very nature of all electromagnetism is a wheel, as is the co-axial geometry of same. Spatial electrical and magnetic components, induce each other THRU, as is necessitated, the counterspatial dielectric center axial and radial point. Linear and circular polarization alike.

Magnetic lines of induction cannot terminate in space nor can dielectric ones. The radial axle of the geometry of light is absolutely necessitated, it cannot exist in any other way, and certainly not the “self-conjugating and self-capacitance” conceptions as currently exist about electromagnetism. The claim that EM is “self-conjugating and inducing self-capacitance” is to claim your car engine pistons are reciprocating upon nothing, no crankshaft of mutual inductive rebounding reciprocation. This is both illogical and impossible. Countless phenomena, including the so-called “photo-electric” (really the radial-dielectric) effect proves this to be the case. As mentioned before, electricity can only induce or terminate into or as magnetism thru dielectricity.

BELOW: Left, high power low loss ‘air coaxial’ cable employing an outer EM reflector/ shield, and the center radial dielectric pipe which guides the dielectric down the pipe. Middle picture is circular polarization. Right are the three components of TEM.

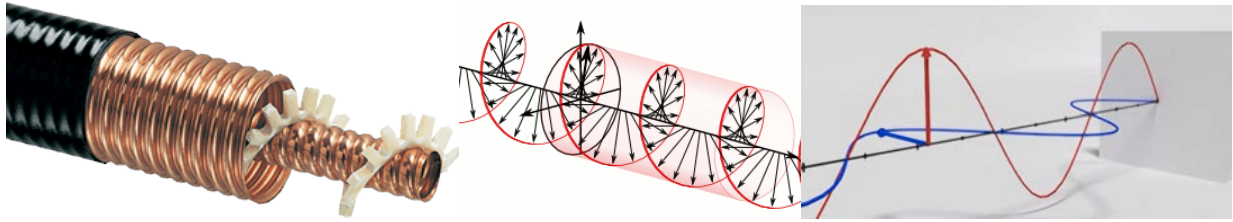

There is more than ample proof that Oliver Heaviside knew the geometry of EM, however he does not outright declare same, but in his writings “a perfect conductor is a perfect obstructer” there is much indication, and the pinnacle to all of this is the fact that Heaviside invented the very coaxial cable itself.

Light does not bend around supermassive objects such as has been observed around our sun, rather the accumulative field of both gravity and dielectricity as the hub of all electromagnetism and light are centripetally attractive just as are the inverse spins of any polarized magnetic field.

Dielectric susceptibility thru a dielectric medium is the proportionality to the frequency as necessitated by permittivity of the electromagnetic geometry upon the dielectric ‘conductor’ at the Z-axis to refraction.

Dielectro-electromagnetism behaves like both matter “particles” and as waves because the Z-axis of the dielectric radial component and its co-axial nature produce said results, with likewise additive and negating bands due to the electromagnetic component.

The absurd belief that electromagnetic waves as ‘self propagating’ and ‘self-inductive’ transverse waves with electric and magnetic fields oscillating at right angles to the direction of propagation is a product of quantum mysticism and has no basis in reality. The Z-axis of electromagnetic propagation is the dielectric, the bounding inertial counterspatial barrier which induces and reciprocates both the electric and magnetic in wavelength and amplitude.

BELOW: Left, circular and linear propagation, likewise on the picture at right.

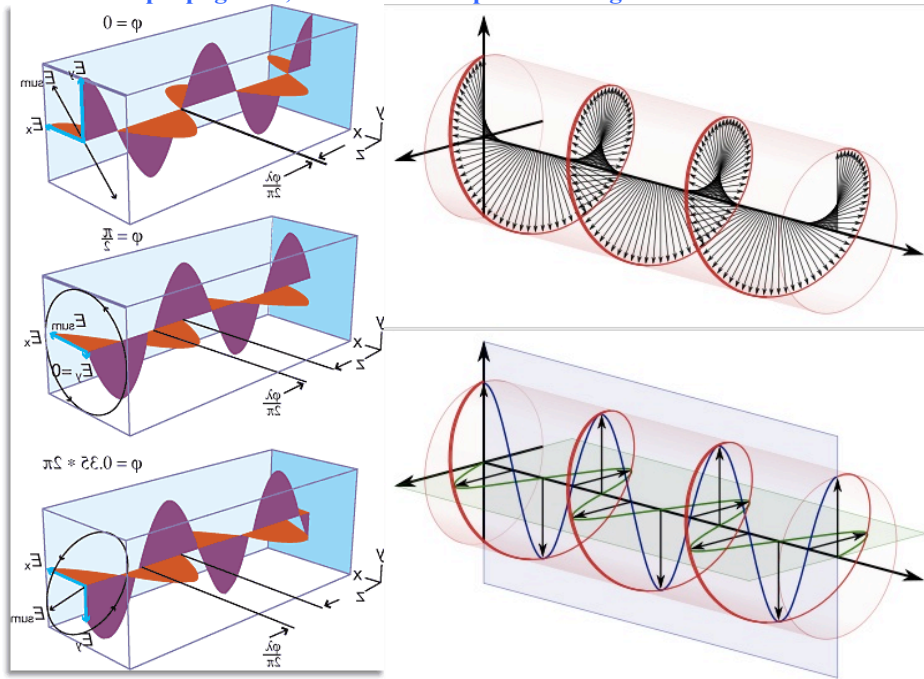

Just as sound requires a medium of propagation, likewise so too does electromagnetism. The photon of quantum mysticism is purely an abstraction in speaking of the dielectric rays of pure inductance which lay at the Z-axis of EM radiation. The medium of EM is the Ether-dielectric plane of centripetal inertia, which reciprocates E and M spirally along its axis at sourced wavelengths and amplitudes.

A ray of dielectric induction is the bounding plane at which electromagnetism transversely conjugate along what was incorrectly thought to be an 'imaginary axis', which is an empirical and logical impossibility.

The dielectric field of induction, Ψ , in Coulombs, produces an electro-static potential, e , in Volts. Conversely an electro-static potential, e , in Volts, produces the dielectric field, Ψ , in Coulomb which reciprocally produces to the magnetic, or Φ . Dielectric and magnetic proportionality along with their conjugating electrical component comprise the electromagnetic propagating spatio-electric boundary of the dielectric radial momentum as defined in the electromagnetic structure.

BELOW: This chart really is that simple. Mass/atoms are dielectric condensates created by enormous power (see galactic jets above) and other stellar formations. Light on the other regard, has a Z-axis dielectric radial component. For lack of better terminology, the incorrect insanity of Quantum-atomism's "wave particle" duality is that light is a quasi-matter phenomena. Extreme powers applied to the dielectric hyperboloid causes inertial plane torque and creates the fundamental particle all matter and atoms are based upon. Literally, light and matter are two modalities of dielectric condensates, one is 'stable', the other is carried along by its directing transverse electric and magnetic constituents. Amusingly, since both matter and light are Ether field modality expressions of dielectricity, one could (humorously) call light dielectricity-lite, and matter dielectricity-heavy. Both light and matter are merely field modalities that have conformed to the conditions of their formation. Creating light is rather easy, as must be logically so; creating the fundamental particle matter, however, takes enormous power.

GIVING DEFINITION TO THE INCORRECT 'wave/particle duality' NONSENSE. LIGHT, OR QUASI-MATTER (for lack of a better term) EXHIBITS BOTH 'wave & particle-like' PHENOMENA BECAUSE, LIKE A PARTICLE, LIGHT HAS 3 COMPONENTS, TRANSVERSE ELECTRIC AND MAGNETIC, AND A Z-AXIS RADIAL DIELECTRIC. LIGHT CANNOT EXISTS AS MERELY "electromagnetism". THIS LONG-HELD PREMISE IS IMPOSSIBLE

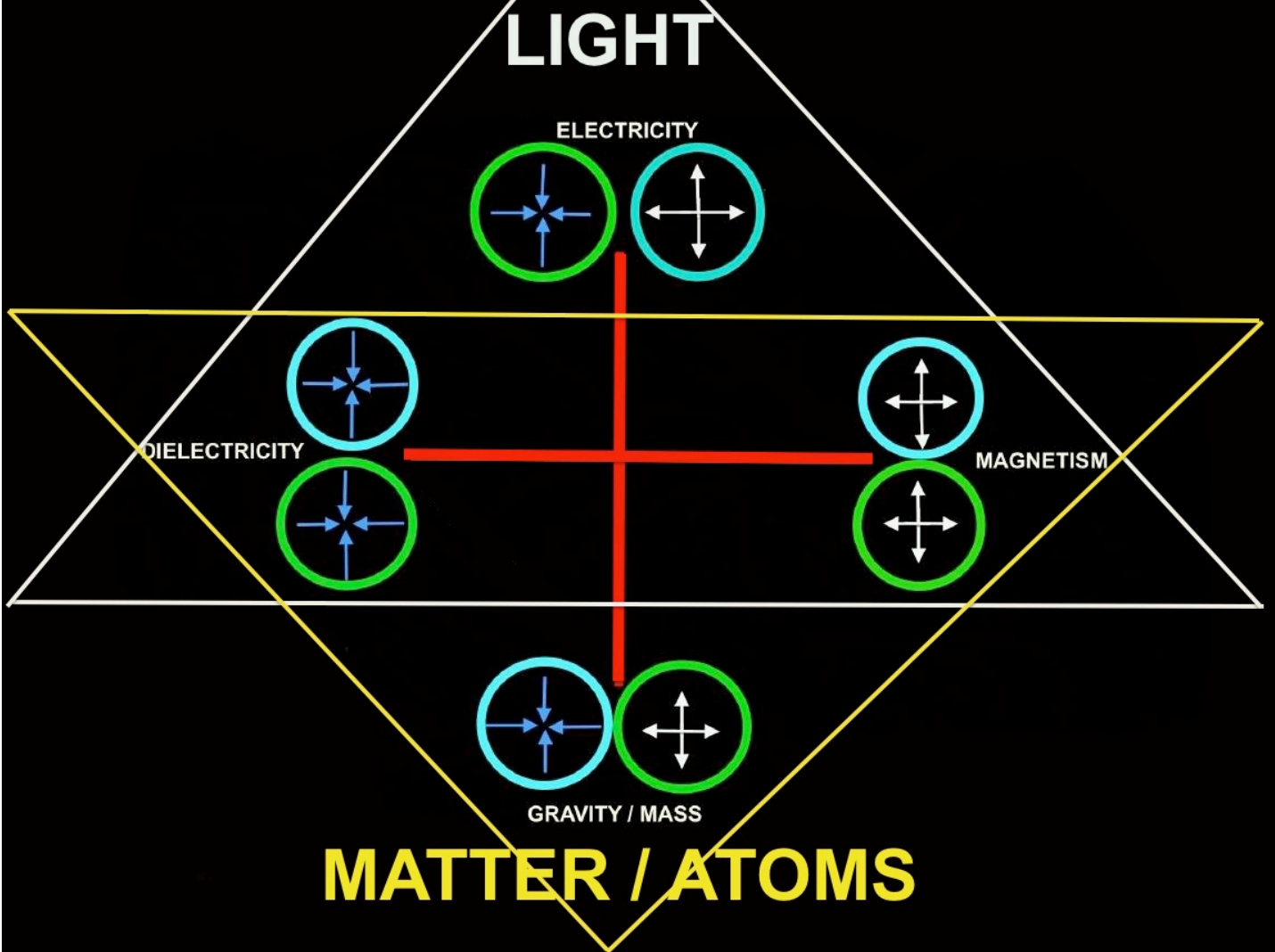

IT REALLY IS THIS SIMPLE

COPYRIGHT 8-15-2014 Ken L. Wheeler

The product of a single line of dielectric induction with a line of magnetic induction gives birth to a unit of electrification, Q. The idea of a photon, or 'quantum unit' of electromagnetic induction is incorrect. The EM capacitance is purely along the Z-axis of the ray-dielectric at the center of reciprocating EM thru the dielectric counterspatial plane in the genuine model of EM propagation.

The four dimensions of electrical engineering, time, space, dielectricity, magnetism comprise the 5-part (in time and wavelength/amplitude) model of electromagnetism thru a vacuum as must be necessitated. This is also a defining aspect of EM being 'quasi-matter', which is merely a misnomer as to the co-axial nature of EM and the dielectric geometry of all electromagnetism.

BELOW: The missing secret of light is now, for the first time ever, rationally exposed, deconstructed, and unites every phenomena known to exist around and regarding light. This explains the supposed “wave particle duality”, it explains the Faraday effect, it explains the photo-electric effect, explains the manner by which light can be twisted by magnetic fields, explains why light can be deflected by extremely strong centripetal gravitational fields. **The idiot Einstein said:** “We are faced with a new kind of difficulty. We have two contradictory pictures of reality; separately (particle and wave theory) neither of them fully explains the phenomena of light, but together they do.” The ‘photon’ is a purely arbitrary concept. Einstein wrongly concluded light was a discrete wave-packet. He called such a wave-packet a ‘light quanta’. Light, in fact, is D.E.M (dielectro-electromagnetic), a tri-fold circuit. The fundamental mass particle itself being a dielectric accretion formed in galactic formations, it is no coincidence whatsoever that light, like an atom itself, has dualistic properties of both waves and a beam of elements.

THERE IS NO 'WAVE-PARTICLE DUALITY', ONLY A MISUNDERSTANDING OF THE ARCHITECTURE OF LIGHT. THIS EXPLAINS ALL PRESUMED PARADOXES OF LIGHT, EXPLAINS THE PHOTO-ELECTRIC EFFECT, EXPLAINS THE FARADAY EFFECT, EXPLAINS THE ARBITRARY CONCEPT OF THE 'PHOTON'. 'SELF-PROPAGATING EM' IS IMPOSSIBLE. IT CANNOT EXIST. ALL INSANITY OF "QUANTUM" THEORY IS BASED UPON AN ARBITRARY BUILT-UP CONCEPT OF THE 'PHOTON' TO RATIONALIZE THE QUASI-MATTER PHENOMENA OF LIGHT AS "BOTH PARTICLE AND WAVE".

LIGHT, THE ELECTROMAGNETIC SPECTRUM IN PROPAGATION BEHAVES LITERALLY LIKE A STRING OF 'PARTICLES', DUE TO ITS TRANSVERSE E-M COMPONENTS AND ITS RADIAL DIELECTRIC PULSES WHICH VARY IN OCCURRENCE AND INTENSITY PROPORTIONAL TO WAVELENGTH, FREQUENCY

CURRENT UNDERSTANDING IS PURELY A MISUNDERSTANDING

A PRESUMED 'QUANTA' OF LIGHT. PROPERTIES OF BOTH PARTICLE AND WAVE. THE ANSWER TO QUANTUM INSANITY WHICH INVENTED THE 'WAVE PARTICLE' DUALITY AND PHOTON; IS A DIELECTRIC PULSE

THE 'DROP' ANALOGY
Particle
Wave

WAVEFORM & DIELECTRIC RADIAL PULSE

The shorter the wavelength, high frequency D.E.M (dielectro-electromagnetic) light, the more dielectric pulses, the more power, the higher the energy.

The idiot Einstein said: "We are faced with a new kind of difficulty. We have two contradictory pictures of reality; separately (particle and wave theory) neither of them fully explains the phenomena of light, but together they do"

THE PHOTON IS A PURELY ARBITRARY CONCEPT. Einstein wrongly concluded light was a discrete wave-packet. He called such a wave-packet the light quantum (das Lichtquant)

COPYRIGHT 7-12-2014 Ken L. Wheeler

Dielectricity is a radial force, magnetism is a circumferential force, electricity is a spherical centripetal force, likewise the Ether itself is the omnipresent ‘point-force’ of which magnitude cannot and does not apply. All forces are vortex in nature.

Light through a dielectric medium is the square root of the inverse of the change of capacitance as mediated thru the dielectric medium of propagation. Therefore capacitance is a directional relationship with the luminal velocity of light in any medium of propagation. If there is 0 capacitance there is, of course, infinite speed.

The product of the magnetic permeability, Mu, and the dielectric permittivity, Epsilon, is 1/Csquared. This forms the basis of electromagnetic wave propagation thru the Ether, this transverse dielectro-electromagnetism bounded coaxial formation. The product Mu – Epsilon is the metrical relation of the Ether, which is the carrier of light.

The coaxial cable is known as the "Electromagnetic Boundary Condition" and it facilitates the existence of a guided electromagnetic wave. The metallic structures establishes the electric circuit, but it does not directly convey the electromagnetism. This metallic structure is wrongly called the "electric conductor," but its actual function is to define a pair of closed loops and the radial dielectric conductor thru with E and M reciprocate and conjugate thru. These loops serves to confine, or "bottle," the electromagnetic energy in the dielectric space enclosed by the system of conductors.

BELOW: The “drop” analogy of light and the “electromagnetic spectrum”. Radial light energy transference begins with the dielectric pulse, which in discharge creates a magnetic pulse, in combination both the dielectric and magnetic produce the electric component of light; this trifecta is instantaneous. This is the trifold circuit is the missing secret of light so horribly perverted by quantum with insane rationalizations and absurd conclusions. The ‘photon’ was created as a purely arbitrary concept to explain the seemingly dual quasi-matter nature of light, which exhibits both particle and wave-like attributes. However this is easily explained by the D.E.M (dielectro-electromagnetic) circuit in a single pulse of light.

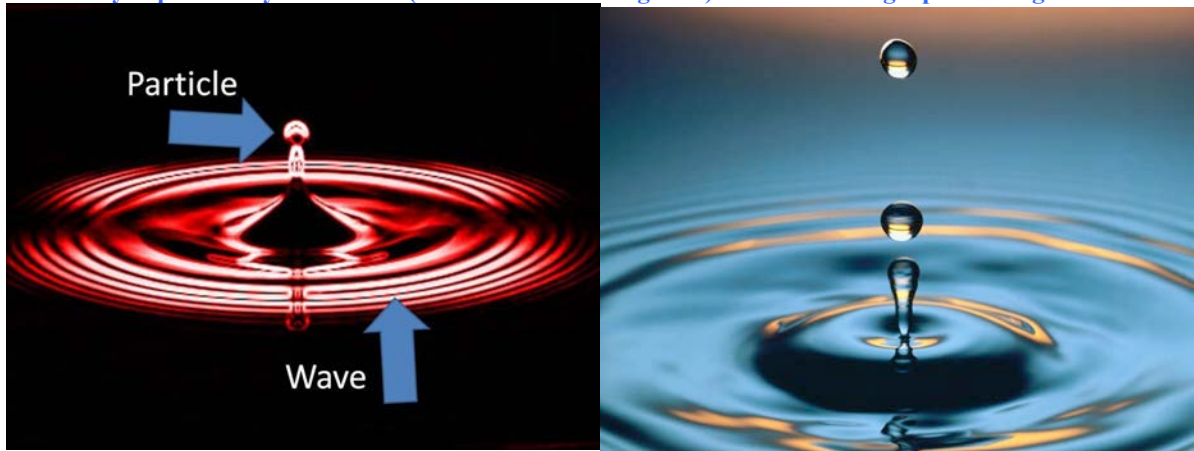

BELOW: The ‘drop’ analogy on left, in which, proportional to wavelength, there are dielectric radial pulses which maintain the structure of light. Magnetic deflection of light can only exist if the significant carrier is a radial dielectric, just like a coaxial cable. On the right, the current understanding of light is purely a misunderstanding.

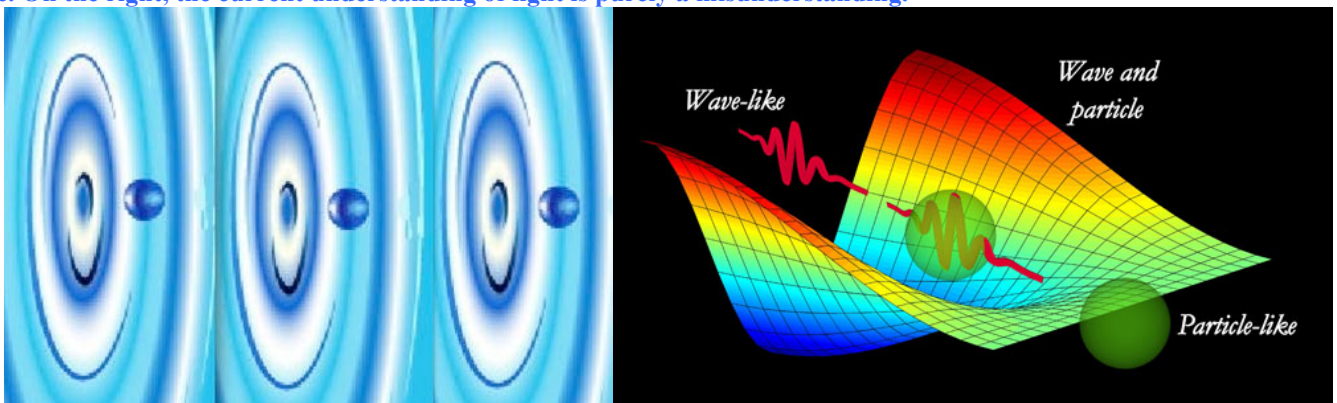

BELOW: All manner of light phenomena can be explained by the D.E.M (dielectro-electromagnetic) circuit theory of light.

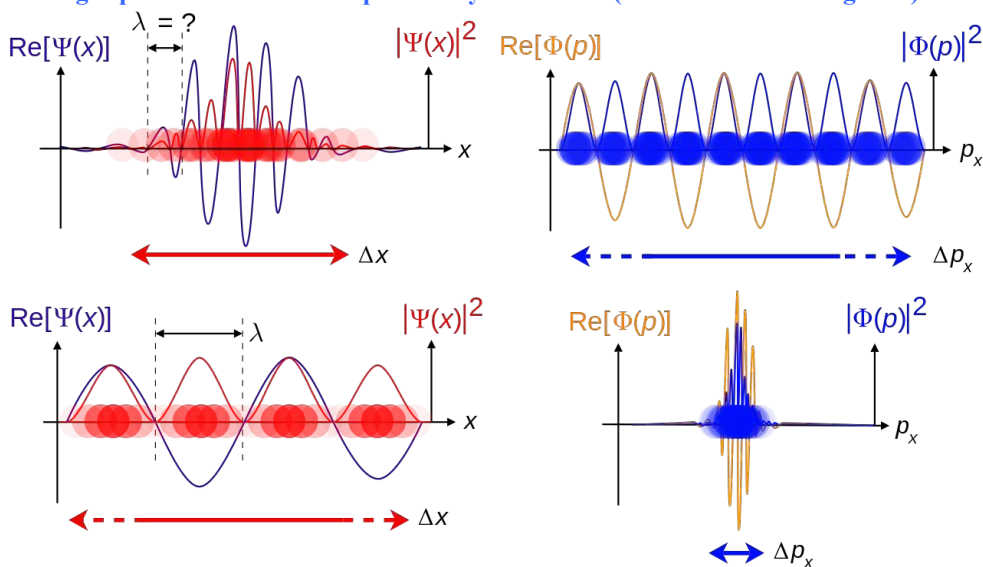

Dielectro-electromagnetism in the higher dielectric-energetic end of the spectrum (Xray, gamma) have more energy due to the proportional dielectric capacitance relational to the frequency of the bounding EM structure at emission.

Electromagnetism does not travel thru space, rather conjugates and reciprocates along the dielectric Z-axis which is the radial conductor, the energy carrier, and the genuine “ray” of light. Like pistons, electromagnetic bounding structures keep the dielectric radial in check as the actual “electromagnetic” point-line of propagation. The electrical and magnetic components induce each other thru the dielectric, from field to field, in endless reciprocating actions.

BELOW: Left, single component of dielectro-electromagnetic geometry. Right showing how shorter wavelengths equal higher kinetic energy. Shorter wavelengths also have spatially smaller EM reciprocation, meaning higher dielectric energy capacitance.

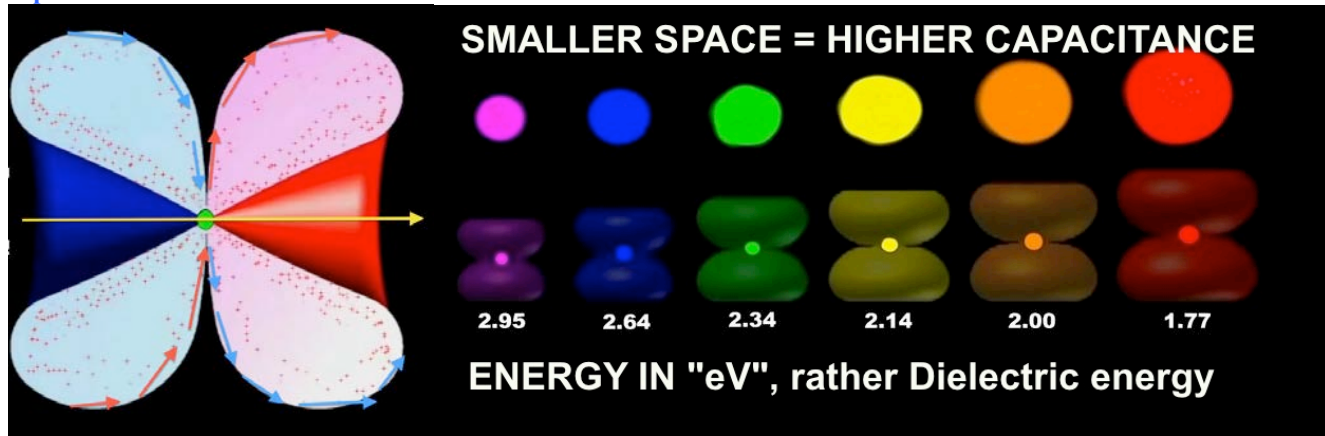

There are two ways to deliver identical amounts kinetic energy in TEM of dielectric radiation to a target, a large volume of coherent radiation as in a laser, or a small volume of incoherent radiation of a short wavelength (gamma, X-ray) comprising a center-axial with an extremely high kinetic radial energy capacitance.

BELOW: Exactly like a power drill, the more revolutions per second, or in the case of light, the shorter the wavelength, the more power is brought to bear in the coaxial system. Drill bit, or light, same analogy, increase in power, increase in revolutions (= shorter wavelength). Draw more power to the drill to increase physical power to the bit to drill thru tougher more dense materials is the same with “electromagnetism”, which is why X-rays, gamma rays etc. ‘drill’ right thru dense matter, transfer power and can cause immense damage. The magnetic component of traditional “electromagnetic” geometry cannot affect damage or power at shorter wavelengths, nor can its reciprocating transverse electrical component; only the coherent dielectric radial component can. The nonsense of “wave-particle duality” is dismissed and replaced with logic and rationality in the true model of dielectro-electromagnetic phenomena. In the diagram below you will need to see this along all 3 axes, Z-axis dielectric, X-axis electrical, and Y-axis magnetic. For illustration purposes the X and Y are laid flat in 2D for illustration purposes, otherwise the Y-axis magnetic would overlay the Z-axis and make the diagram unclear.

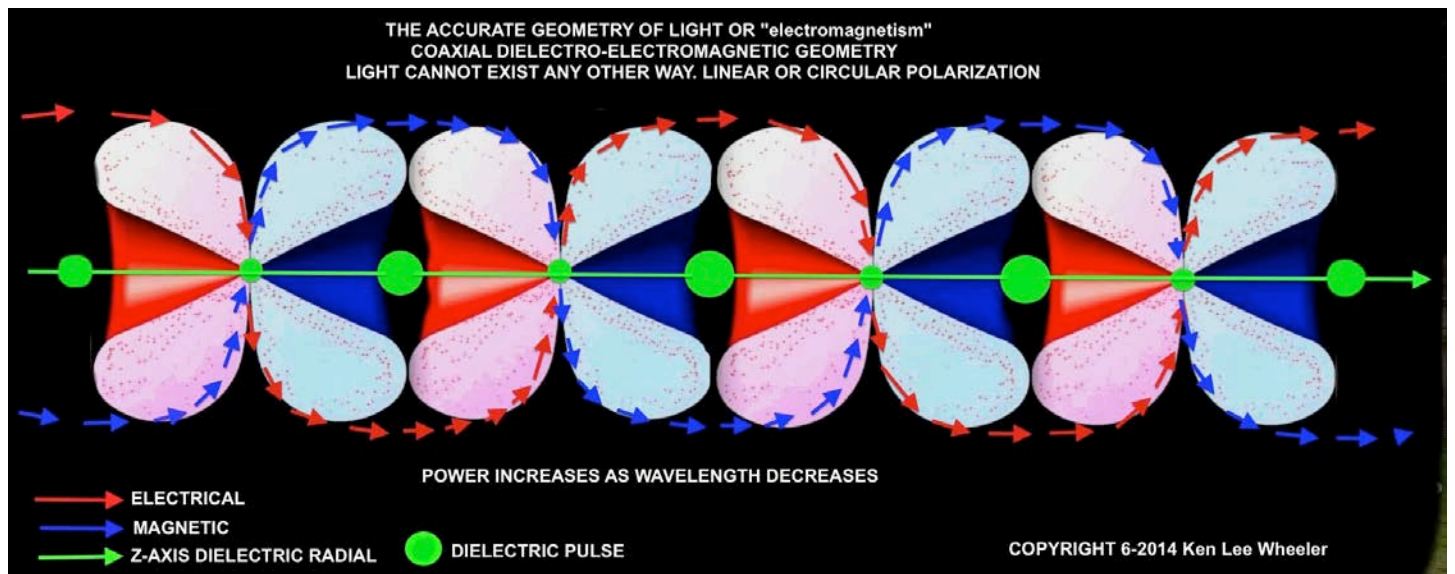

The dielectric charge pulses like a heart depending on wavelength which is proportional to eV power. Pulses change with phase shift and circular or linear polarization, but the continuity is still kept.

Electromagnetic dielectric capacitance is a direct relationship with the velocity of EM in ANY GIVEN MEDIUM. If the medium has 0 capacitance potential, then there is infinite velocity, or a “zero-time-transmission”.

The electromagnetic geometry can only saturate into the medium at the rate at which is defined by said medium. As such light or, EM, can only travel at luminal velocities as constrained by the dielectric medium’s capacitance and its spatial relation of $1/C^2$. Electromagnetism is not a phenomenal or particle projection, this is impossible. It is a pure inductive process of the dielectric core, or nature of all electromagnetic radiation.

Magnetism circumferential and dielectric is only radial however its 3D nature of self-termination is a toroid. Dielectricity forms toroidal closed loops (doughnut shape) in movement as it is induced (pulsed) in the electromagnetic reciprocation of electromagnetism. The perpendicular transverse electrical component as induced by the reciprocating magnetism thru the radial dielectric center ‘conductor’ causes, either linear or circular (or otherwise) polarization of electrification to manifest at which type the cycle reverses in reciprocation. Again, electromagnetism is NOT electromagnetic in nature, but an electrical and magnetic transverse reciprocation thru the radial counterspatial dielectric carrier, to which Quantum, in ignorance, has deemed a “photon”.

Below: A torus of light as seen between a ferrocell in which two magnets are undergoing dielectric spatial voidance. Comprehension of why there is a shrinking sphere of light rather than a radial collapse is of utmost importance. Likewise can be seen with iron filings. Spatial divergence must be necessarily voided by means of a sphere rather than sheer radial voidance. See the section on the hyperboloid.

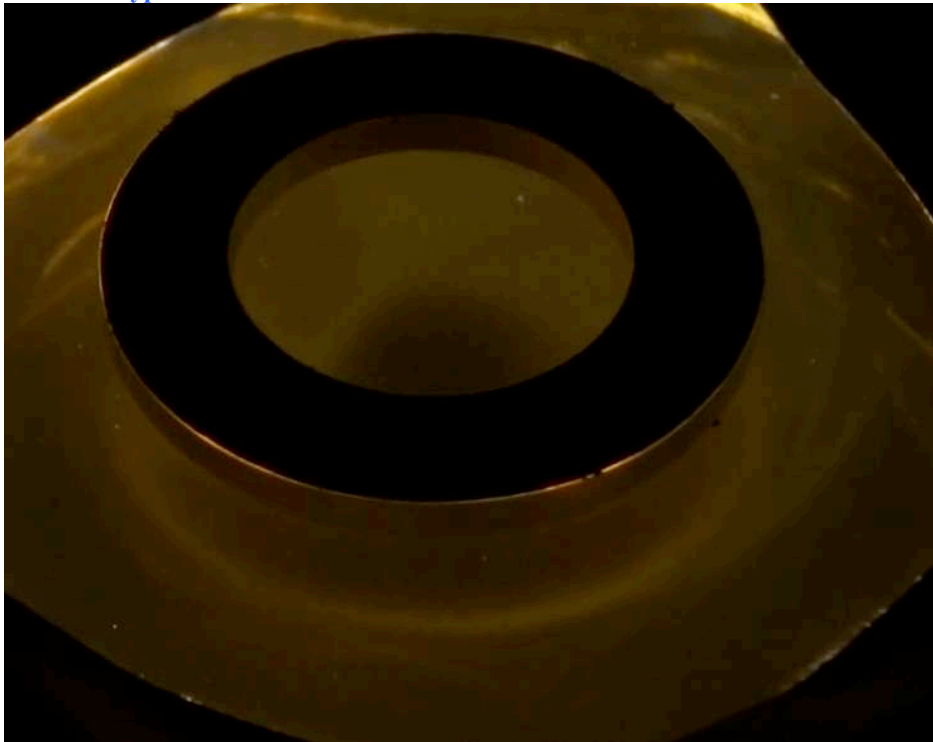

The dielectro-electromagnetic nature of “electromagnetism” is a transverse conjugating and reciprocating co-axial binary vortex of spatial and counterspatial radial emanations which is the most stable and, of course, nature’s way of matter-free energy transmission. This magneto-electric-dielectric geometry is the only possible, the only logical model, and is necessitated by countless known phenomena, therefore the only accurate depiction of electromagnetism. It cannot exist any other way.

As is the nature of dielectricity, the smaller the space, the MORE dielectricity that can be stored, this is why the frequency of an “electromagnetic” bounding geometry is directly proportional to its dielectric capacitance. This is evidenced in the dielectro-electromagnetic effect (wrongly conceived of as the photoelectric effect) where frequency is proportional to the energy propagated.

Below: The so-called “pseudo-sphere” in chain (as per light) of dielectric inertia as seen in the example of dielectro-electromagnetism. Proportional to the wavelength of the light, there are more or less dielectric pulses and likewise proportional increasing or decreasing kinetic energy from the Z-axis radial dielectric component of light resultant from its wavelength. The smaller the space, the higher the dielectric capacitance. Below is a shorter wavelength, and likewise more pulses and energy in transference. This is irrefutable.

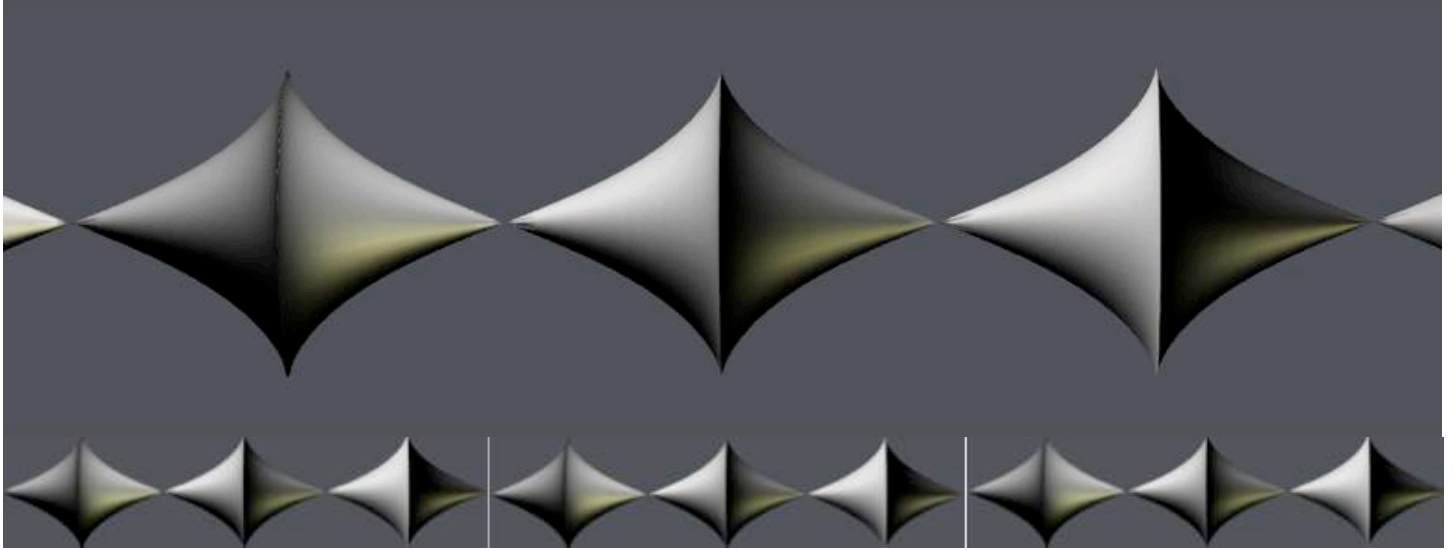

The quadrature of the dielectro-electromagnetic geometry is a union of magnetic induction and dielectric induction, which induce the transverse electrical element perpendicular to the radial Z-axis of dielectric propagation. This quadrature of reciprocating induction and three components is nature’s method of radial mass-free energy propagation.

The propagation of dielectric energy in the “electromagnetic” form is within the bounding transverse “space” of these E and M ‘conductors’. This space is the radial and co-axial centerpoint of “electromagnetic” propagation.

The stable nature of dielectro-electromagnetism, or “electromagnetism” over countless light years is due to the extremely interesting geometry of dielectro-electromagnetic (or “EM”) radiation. As a permanent magnet conjugates outwardly centrifugally and returns (CCW to CW or CW to CCW) centripetally along the lowest pressure gradients, so too does dielectro-electromagnetism conjugate its electrical and magnetic components in pressure gradients in the form of an accretion disk along a radial dielectric element. Whereas a magnet has, inversely but proportionally, at the “Bloch wall” an inertial plane, or accretion disk of centripetal dielectricity, dielectro-electromagnetism has an accretion disk of electrical and magnetic components that conjugate centrifugally and centripetally along the radial dielectric Z-axis.

Magnetism has a center-point dielectric accretion (flattened toroid) disk at which the magnetism conjugates in an inverse sphere (double hyperbola, hourglass geometry) centrifugally-peripherally and centripetally centered along the lowest pressure points. In likewise but ‘opposite’ fashion, dielectro-electromagnetism is the counterspatial-axial and radial-spatial (EM) centerpoint (inverse to a magnet) at which electromagnetic components reciprocate as a spatial accretion disk which is, as necessitated, vortex in geometry.

The Photoelectric effect lie corrected, the dielectric discharge effect

The erroneous Einstein mental failure as currently thought of as a “wave packet” is in fact a dielectric pulse in the radial center of EM propagation. This pulse is proportional to the frequency, the intensity of the EM being emitted as the Z-axis radial-dielectric (wrongly called photo-electric) charges indicate from experimentation. The Quantum notion of a “wave packet” and the ‘photon’ do not exist in the electromagnetic-dielectric model of the EM spectrum. They are phantom misunderstandings of electrodynamics, dielectric capacitance and reciprocating mutual conjugation by and thru magneto-spatial and dielectric-counterspatial co-axial energy formations.

The test and results of the photoelectric experiment are, of course, completely accurate and valid, the **explanation however** (where myopic pseudo-science fails typically) is a pure insane fantasy, both illogical, irrational, absurd, and purely the insane conclusion of Einstein’s idiocy and his atomistic proclivities. **Einstein had absolute NO training or study in electrical theory** ala Tesla, Faraday, Maxwell and others. His only acclaim, his Nobel Prize for the photoelectric effect (not its results, but its explanation!) is a complete lie, fabrication and utter farce in the extreme.

Insanity defined in pure rarified form: “Photons have no mass, but they have momentum and they have an energy”. A massless mass/particle is an absurd premise in the extreme, in defining the so-called photon, which in reality is a radial dielectric Z-axis

component of the so-called “electromagnetism”. It has inertia (not momentum, which is applicable to mass/matter), it of course has energy and is the only component of light that is the source for the energy of both its discharge as magnetism, and its magneto-dielectric mirror in transverse composition as electricity in the dielectro-electromagnetic true nature of light. This applies to the entire ‘electromagnetic’ spectrum. Light itself (as this work expands in form and editions) cannot exist without a Z-axis radial dielectric component, absolutely no different than the coaxial cable.

Below: The lie of the “photoelectric effect” showing non-existent electrons being shot off the reflector. Replace E with energy of the dielectric, h Planck and f frequency remain the same. This diagram is a lie fundamentally since the charged induction from the dielectric resides as capacitance between two charging plates, there is NOTHING (as the wrongly implied ‘discharge particle’) shot off the surface material, and certainly no electrons.

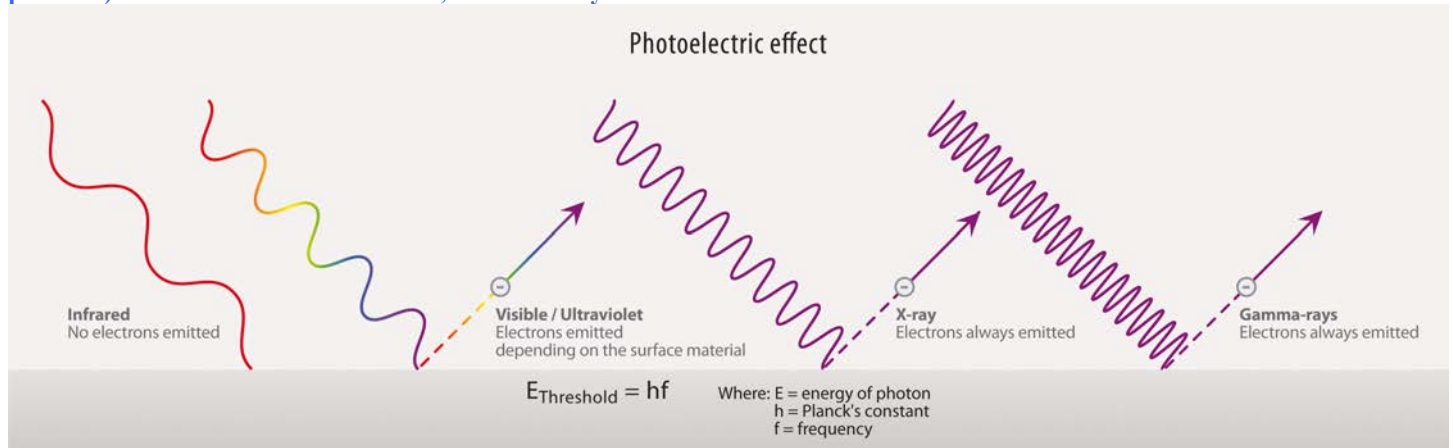

Dielectricity has the attributes of a refractive index depending on the field or material encountered (dielectric, diamagnetic, ferrous, etc.), dielectric inductivity and a luminal velocity when bounded by a co-axial electromagnetic geometry. This dielectric nature explains photoelectrical effects, refraction, dispersion, wave-particle dualities, diffusion, slow down in a dielectric medium, polarization phenomena, and high frequency power in electromagnetics.

In the magneto-electric-dielectric geometry of “electromagnetism”, all magnetic lines are closed in upon themselves and likewise induce the dielectric conductor to electrification. Likewise the dielectric lines of force are counterspatially self terminating in radiating thru space and are the ‘crankshaft’ for electrical and magnetic reciprocation and inductance, which cannot, may not, as is commonly believed “self induce” each other.

Below: What is really occurring is the shorter wavelength TEM is striking a plate in a vacuum tube and causing induction differential between the cathode and anode. This is an electromotive force, not ‘electrons’ (non-existent fabrications) moving between the charged and discharge plate.

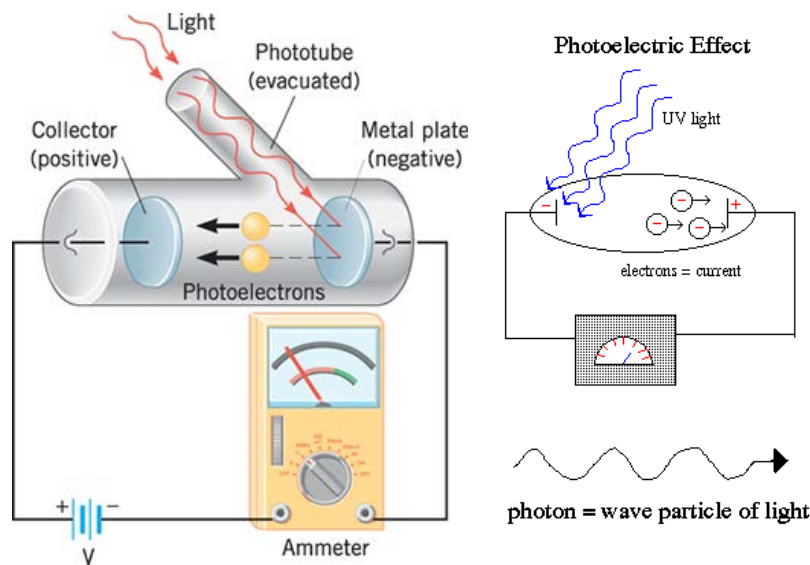

The so-called “photoelectric effect” explains why the energy of the charging dielectric was dependent only on the frequency of the incident light and not on its intensity: a low-intensity, high-frequency source could supply a few high energy dielectric pulsations, whereas a high-intensity, low-frequency source would supply no radial dielectric pulsations of sufficient energy to cause charge upon the striking surface.

Einstein's unintelligent conclusions were that this wrongly conceived "photoelectric effect" contradicted the wave theory of light that followed by J.C. Maxwell's equations for electromagnetic behavior, however the truth of course is that this observed effect is the resultant of charging from dielectric inductance from the radial center-co-axial nature of high-energy and frequency light which is dielectro-electromagnetic. Contrary to belief, they did not contradict Maxwell's equations in the observed results, rather proved the central axial conductor of electromagnetism, the dielectric, however wrongly interpreted and understood by the lesser mind of Einstein.

Below: The shorter the wavelength, high frequency D.E.M (dielectro-electromagnetic) light, the more dielectric pulses, the more power, the higher the energy.

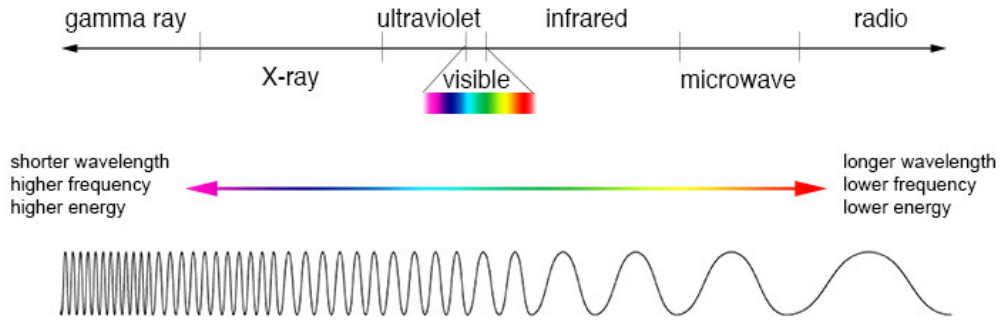

The prediction that the energy in charge created in this effect increases radially with the frequency of the light was accurate, its interpretation however was wholly inaccurate.

Below: On the left is a cylinder magnet above a ferrocil in which the light is being displaced by the centrifugal magnetism and directed along the dielectric inertial plane of the magnet in perfect expected field mediation as explained much earlier as per the F.I. of how mutually repulsing inertial dielectric and divergent centrifugal magnetic radiation mediate out pressure gradients in the binding system of the 'magnet'. On the right is the accurate illustration of the field mediation in any and all 'magnets' and likewise the light which is deflected from the divergent magnetism and concentrated at, focused at the dielectric inertial plane. Photo courtesy T. Vanderelli.

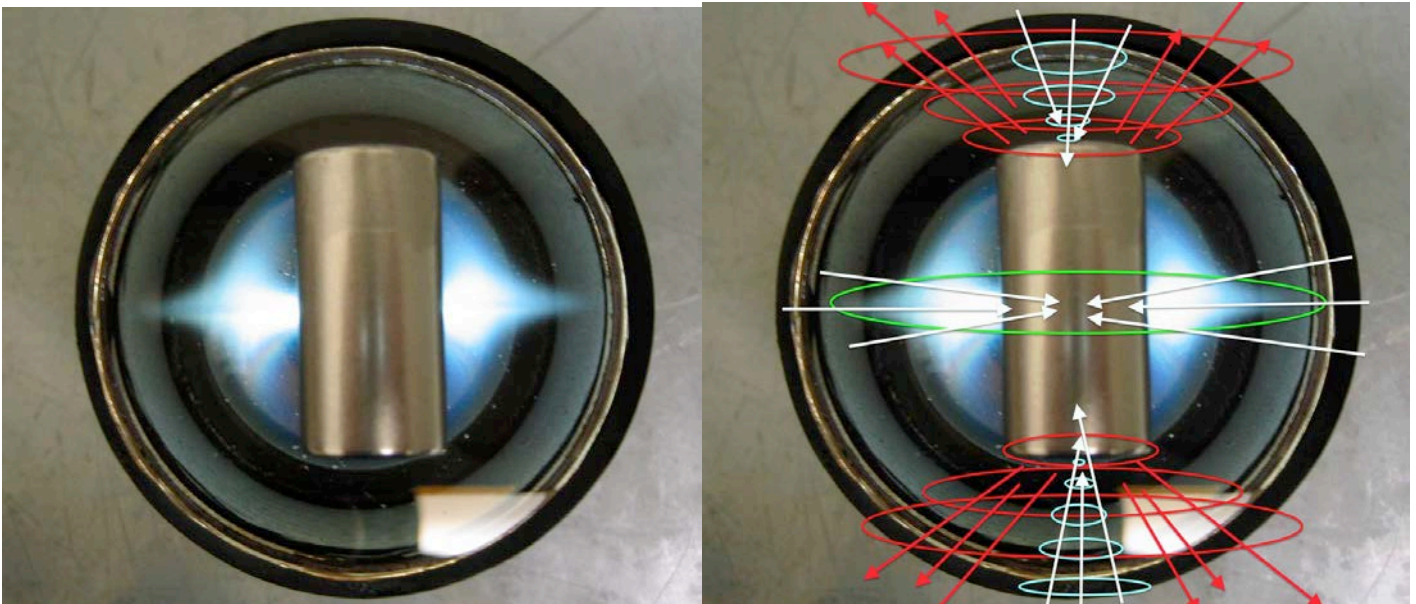

The wrongly conceived photoelectric effect helped to propel the then-emerging quantum mysticism forward in a radical fashion. Light simultaneously possesses the characteristics of both waves and particles, each being manifested according to the circumstances, however horribly misunderstood by Einstein and his henchmen, and likewise their blind followers.

The effect was impossible to be understood in terms of the classical wave descriptions of light obviously, since the energy of the charge did not depend on the intensity of the incidental EM radiation.

Refraction and dispersion of light thru a medium

The refraction of light thru a medium depends upon the wavelength and is proportional to the dielectric capacitance of the medium of propagation.

Dielectric susceptibility thru a dielectric medium is proportional to the high frequency low wavelengths, due to the permittivity of the bounding electromagnetism upon the dielectric Z-axis to refraction.

The reason energetic blue light is diffracted more is due to the motional breaking thru the dielectric medium by the bounding EM which deflects the blue wavelength higher-dielectric-energetic frequencies much more so than the less energetic red.

Literally the higher power shorter wavelengths have FAR greater dielectric capacitance. More dielectric pulses and energy over a given length than, for instance infrared, and the tighter the bounding structure, the more dielectricity. This is the fundamental electrical-geometry of counterspatial capacitance, or dielectricity. This and this alone is the missing secret of light, the coaxial radiant geometry of light for the very first time ever discovered here, in this paper. The mystery of shorter wavelengths = more power = more energy is over. Simplicity in divinity. Lights coaxial Z-axis radial dielectric geometry is now laid bare in its glaring simplicity.

Shorter wavelengths = more dielectric pulses = smaller spatial geometry which also = higher dielectric capacitance. Literally the power increases on two levels exponentially as wavelengths decrease! More pulses and more power. Smaller confining EM geometry, higher dielectric capacitance.

Below: On the left showing the spatial EM boundaries as proportional to the wavelengths and likewise therefore to the radial capacitance of the dielectric coaxial carrier. On the right, showing wavelength deflection, the refraction gradient thru the dielectric glass or plastic medium.

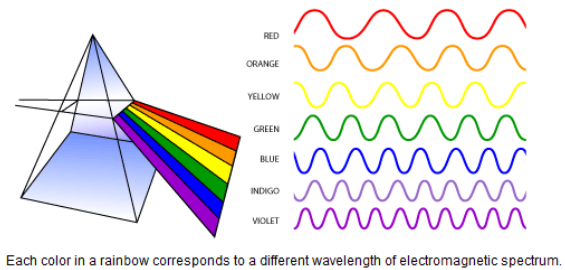
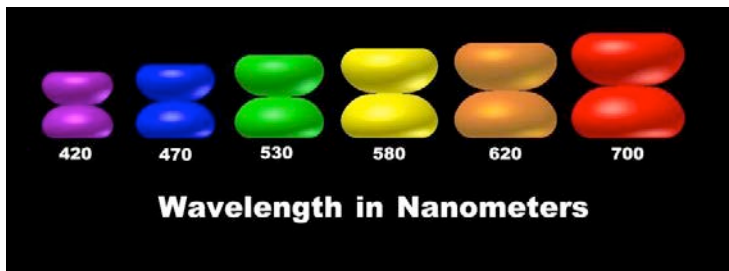

Below: Dielectric radial pulse capacitance occurs proportional to the wavelengths, shorter wavelengths carry more kinetic energy, longer wavelengths carry less.

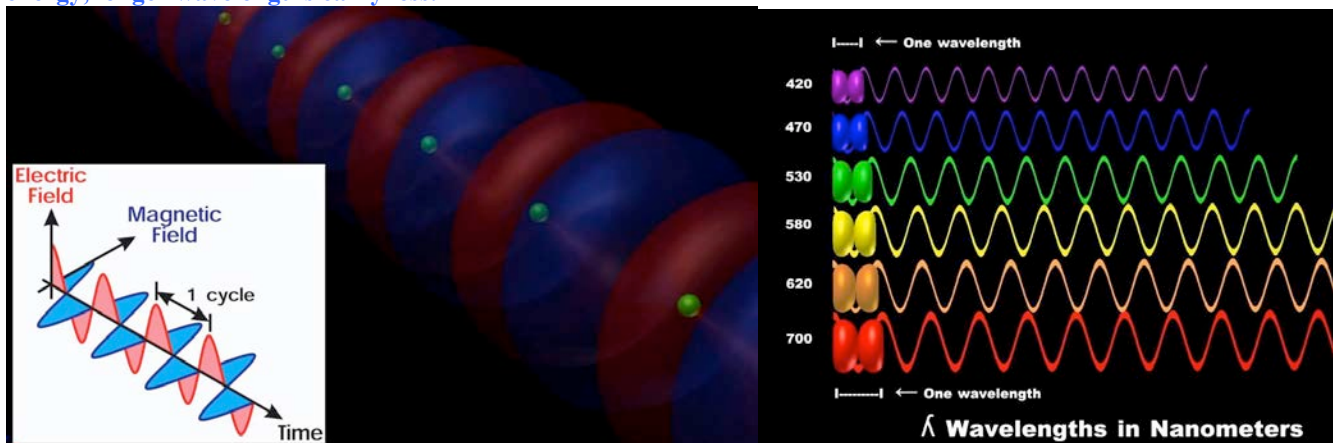

Below: Shorter wavelength light contains higher dielectric capacitance, and likewise are more kinetic in their energy transfer. On right, shorter wavelength light is deflected more due to the rate at which the induction can occur in the medium of transmission, thru the dielectric capacitor (or 'insulator', i.e. glass etc.).

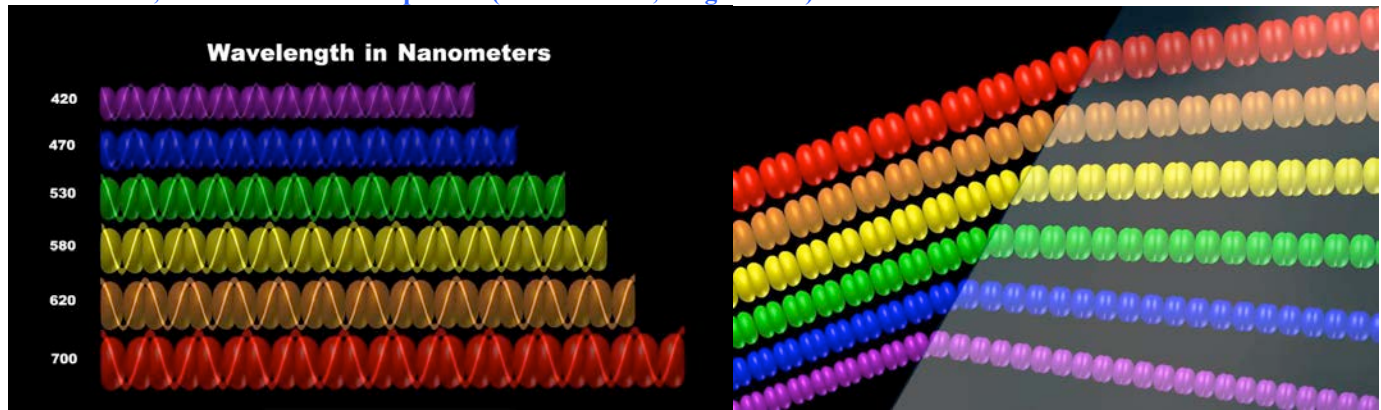

Kha and other words denoting 'zero', the metaphysics of counterspace, and the ancient wheel analogy of space & counterspace

Adapted from the works of Dr. A.K. Coomaraswamy, of which his son, Dr. R.P. Coomaraswamy, has granted me full rights to all his fathers' works in 2006.

Below: All cubic space is the resultant of magnetic divergence, as necessitated without exceptions, $0 = X - X$. Zero does not exist, rather as both meant and implied unmanifest inertia in counterspace; i.e. the Ether. The 'square' piece lower left is the exact same piece on the right, only from a different angle.

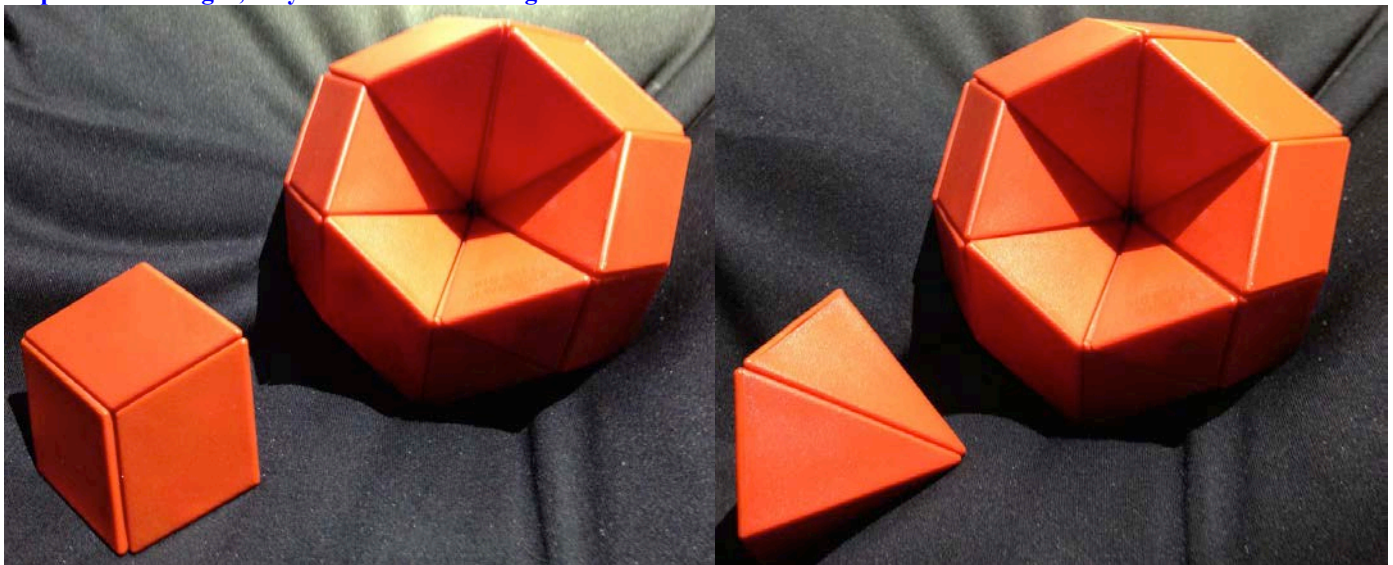

Kha, cf. Greek Xaos, is generally "cavity"; and in the Rg Veda, particularly "the hole in the nave of a wheel through which the axle runs" (Monier Williams). A. N. Singh has shown conclusively that in Indian mathematical usage, current during the earlier centuries of the Christian era, kha means "zero";Suryadeva, commenting on Aryabhata, says that "the khas refer to voids (khaini sunya upa lakptani) ...thus khadvinake means the eighteen places denoted by zeros." Among other words denoting zero are sunya, akasa, vyoma, antariksa, nabha, ananta, and purna. We are immediately struck by the fact that the words sunya, "void," and purna, "plenum," should have a common reference; the implication being that all numbers are virtually or potentially present in that which is without number; expressing this as an equation, $0 = X - X$, it is apparent that zero is to number as possibility is to actuality. Again, employment of the term ananta with the same reference implies an identification of zero with infinity; the beginning of all series being thus the same as their end. This last idea, we may observe, is met with already in the earlier metaphysical literature, for example RV IV.I.II, where Agni is described as "hiding both his ends (guhmano anta) "; AB 111.43, "the Agnistoma is like a chariot wheel, endless (ananta)"; JUB 1.35, "the Year is endless (ananta), its two ends (anta) are Winter and Spring . . . so is the endless chant (anantam saman)." These citations suggest that it may be possible to account for the later mathematicians selection of technical terms by reference to an earlier usage of the same or like terms in a purely metaphysical context.

Our intention being to demonstrate the native connection of the mathematical terms kha (zero, counterspace), etc., with the same terms as employed in purely metaphysical contexts, it will be necessary to prepare the diagram of a circle or cosmic wheel (cakra,

mandala) and to point out the significance of the relationships of the parts of such a diagram according to universal tradition and more particularly in accordance with the formulation of the Rg Veda. Take a piece of blank paper of any dimensions, mark a point anywhere upon it, and With this point as center draw two concentric circles of any radii, but one much less than the other; draw any radius from the center to the outer circumference. With exception of the center, which as a point is necessarily without dimension, note that every part of our diagram is merely representative; that is, the number of circles may be indefinitely increased, and the number of radii likewise, each circle thus filled up becoming at last a plane continuum, the extended ground of any given world or state of being; for our purpose we are considering only two such worlds mythologically speaking, Heaven and Earth, or psychologically, the worlds of subject and object as forming together the world or cosmos, typical of any particularized world which may be thought of as partial within it. Finally, our diagram may be thought of either as consisting of two concentric circles with their common radii and one common center, or as the diagram of a wheel, with its felly, nave, spokes, and axle point. Nabha, from nabh, to "expand," etc., as also in nabhi, "navel" and "nave." A secondary sense of nabh is "to destroy" (in counterspace, voidance). Actually to represent all possible states of being, the Wheel would have to be conceived in the manner of a gyroscope, revolving simultaneously in an indefinite number of planes, though still with a motionless center: just as the Cross must be thought of from this point of view as constituted of three arms, mutually at right angles, intersecting at the one common point which is also the center of the sphere in which the Cross stands. Actually, however, this would be to introduce a needless complication, and in fact the symbol as employed is essentially an ordinary chariot wheel, just as also in common usage the two armed cross stands for a cross extended in three directions. Although, then, the Wheel, as the "round of the world" and "earth plain," strictly speaking corresponds only to a given ensemble of conditions it represents analogically the indefinite totality of all possible conditions, the entirety of samsara. As thus representing the Universe in its entirety, the Wheel symbol remains in use unchanged from Rg Veda. The content of the wheel symbolism is extraordinarily rich, and can only be outlined here. Its dimensions are indefinite, its radius the variable distance between an undimensioned (amatra) point and an immeasurable (asankhya) circumference; there in the "middle space" (antariksa, akasa), between the "I" and the "not I," essence and nature, lie procession and recession (pravrtti, nivrtti), there are good and evil (dharmadharmau), joy and sorrow (sukha, duhkha), light and shade (chayatapa), birth and death, all local movement and affection; and that motion and passibility are greater the greater the distance from the centre. Beyond the felly lies only the inexistence of the irrational, an impossibility of existence, as of square circles or the horns' of a hare; within the nave, the non existence of the supra rational. The cycle of ego consciousness implies an outward movement from the nave to the ever-receding felly, and a return from the however distant felly to the unchanging center. A progressive enlightenment (krama mukti) can then be expressed 'as a gradual contraction of the radius, bringing the circumference ever closer to the center, until that which seemed to enclose the point is seen to lie contained within it, knowledge being thus concentrated into a single form, which is the form of very different things. That is Nirvana, unitary being, "with residual existential elements," and by a vanishment of the point becomes also epistrophe, synthesis, without residuum of existence.

Below: The magneto-dielectric archetype, seen face on.

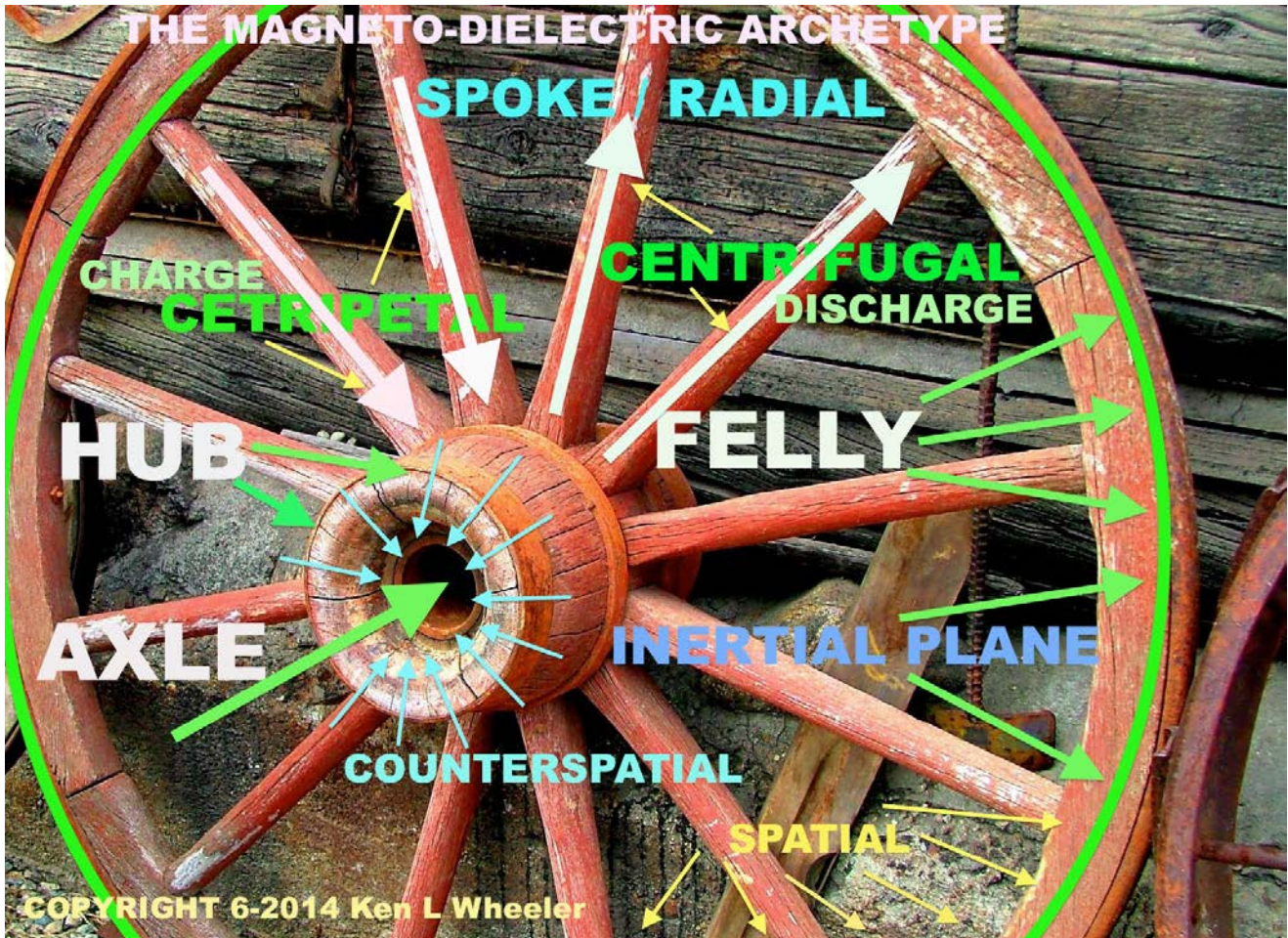

Now in the first place, as a geometrical symbol, that is to say with respect to measure or numeration, our diagram represents the logical relationships of the concepts naught or zero, inconnumerable unity, and indefinite multiplicity; the blank (sunnya) surface having no numerical significance; the central point (Indu, bindu) being an inconnumerable unity (inconnumerable, advaita, because there cannot be conceived a second center); and either circumference an endless (ananta) series of points, which may be thought of as numbers; the totality (sarvam) of the numbered, that is to say individual, points representing the sum of a mathematically infinite series extending from one to "infinity," and conceivable as plus or minus according to the direction of procedure. The whole area (sarira) delimited corresponds to place (desa), a revolution of the circles about their center corresponds to time (kala). It will be observed further that any radius connects analogous or corresponding points or numbers on the two circumferences; if, now, we suppose the radius of one or both circles indefinitely reduced, which brings us to the central point as limiting concept (that is also "as it was in the beginning"), it is evident that even this point can be thought of only as a plenum of all the numbers represented on either circumference. On the other hand, this point, at the same time that it represents an inconnumerable unity and, as we have seen, a plenum, must also be thought of as representing, that is, as the symbol of, zero, for two reasons: (1) inasmuch as the concept to which it refers is by definition without place and without dimensions, and therefore nonexistent, and (2) the mathematically infinite series, thought of as both plus and minus according to direction, cancel out where all directions meet in common focus.

So far as I know, Indian literature does not provide a specifically geometrical exegesis exactly corresponding to what is given in the preceding paragraph. What we do find in the metaphysical and religious traditions is a corresponding usage of the symbol of the Wheel (primarily the solar chariot, or a wheel thereof), and it is in this connection that we first meet with some of the most significant of those terms which are later on employed by the mathematicians. In RV 1.155.6 and 1.164.2, II, 13, 14, 48; AV x.8.4 7; KB xx.i; JUB 1.35; BU 1.5.15; Svet. Up. 1.4; PS 6, and like texts, the year as an everlasting sequence is thought of as an unwasting wheel of life, a revolving wheel of the Angels, in which all things have their being and are manifested in succession; "none of its spokes is last in order" (RV v.85.5). **The parts of the wheel are named as follows:** ani, the axle point within the nave (note that the axle causes revolution, but does not itself revolve); kha, nabhi, the nave (usually as space within the hub, occasionally as the hub itself); ara, spoke, connecting hub and felly; nemi, pavi, the felly. It should be observed that nabhi, from nabh, to expand, is also "navel"; similarly in anthropomorphic formulation, "navel" corresponds to "space" (MU vi.6); in the Rg Veda, the cosmos is constantly thought of as "expanded" (pin) from this chthonic center. We considered above mainly the case in which the cosmic wheel is thought of as single

perhaps more often the chariot of the Sun is thought of as running on twin wheels connected by a common axle tree (aksa), and this involves a consideration of the world from two distinct but inseparable points of view. As the Sun shines equally for angels and for men (leg Veda, I, 50, 5, etc.), so of the twin wheels of his chariot one touches Heaven, the other Earth (Rg Veda, I, 30, 19, and X, 85, 18); and their common axle tree is identified with the axis of the universe that holds apart (vitaram, visvak) Heaven and Earth (Rg Veda., V, Z9, 4, and X, 89, 4). Or again, when the chariot of the Sun is thought of as three wheeled (tricakra), Rg Veda, X, 85, two of the wheels are identified, as aforesaid with Heaven and Earth ("one looks down upon the several worlds, the other ordains the seasons and is born again," cf. I, 164, 44 and 32), and these "proceed by magic", mayaya caranti; but the third is hidden (guha' = guhayam nihitam, sc. "in the heart"), and only the adepts (addhatayah) are Comprehensors (viduh) thereof. This third wheel evidently corresponds to the "secret name". These doctrines of three wheels, three lights, etc., are tantamount to the trikaya doctrine. The axle tree of the twin wheels (which axle must be thought of analogically also as penetrating the third wheel) is the primary source of moving power, or Brahma (as rooted incidentally in leg Veda, I, 166, 9): not itself revolving (important), it is the unmoved mover in relation to the wheels. But to complete our understanding of the pratika it must be realized that the revolution of the wheel requires the operation of an opposing force operative at the felly, where in actual experience contact with the ground supplies a fulcrum. In other words, revolution depends on the interaction of conjoint principles, which may be galled Heaven and Earth, Purusa and Prakrti, sattva and tames, I and not I, subject and object, etc. This is recognized in several passages in which the infixation of the axle, or the movement of the wheels, is effected by the deity by means of his abilities (sacibhih, Rg Veda, I, 30, 15, and X, 89, 4), powers (8`aktibhih, X, 88, 10), or magic (mayaya, X, 85, 18), saci, Sakti, and maya being synonymous feminine designations of his "means whereby," the "ground" of manifestation, cooperating with his "essence," who is Sacipati, Mayin, etc. The axle tree is also the axis of the universe, as most clearly stated in Rg Veda, X, 89, 4, yo akseneva cakriya sacibhih visvak tastambha prthivim uta dyam, "by the axle of his wheeled car indeed, by his abilities, he pillars apart Heaven and Earth".

In China we shall be concerned with only two stone objects, or perforates; these objects of jade are symbols of Heaven and Earth. Of these two perforates, the Tsung, or Earth symbol is internally tubular and externally cubical (figure 15), while the pi, or Heaven symbol is a perforated circular disk or ringstone (figure 16). It is interesting that these Tsung are regularly thought of "cart wheels" or "wheel hubs". But the "ancient jade chariot" no more implies an actual chariot of jade used than does the Vedic chariot of light or biblical chariot of fire refer to vehicles that might be unearthed by archeologists. These are purely symbolic representation of space and counterspace, earth and the unseen, counterspace, conventionally 'Heaven'.

Below: Symbols of Heaven and Earth. Of these two perforates, the Tsung, or Earth symbol is internally tubular and externally cubical (figure 15), while the pi, or Heaven symbol is a perforated circular disk or ringstone (figure 16).

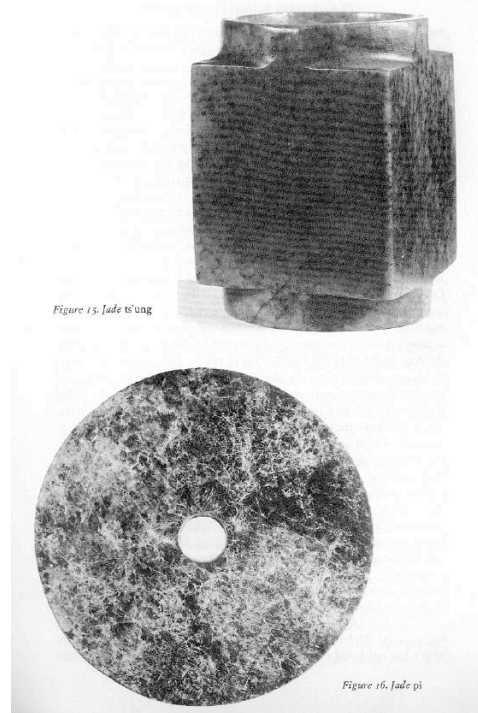

Certain passages indicating the metaphysical significance of the terms ani, kha, and nabhi in the Rg Veda may now be cited. It should be premised that we find here in connection with the constant use of the wheel symbol, and absence of a purely geometrical formulation, the term ani employed to express ideas later on referred to by the words indu or bindu. Vedic ani, being the axle point within the nave of the wheel, and on which the wheel revolves, corresponds exactly to Dante's "il pumadello stelo al cui la prima rota va dintorno" (Paradiso XIII.I I 12). The metaphysical significance of the ani is fully brought out in RV 1.35.6, anim na rathyam amrta adhi tasthuh, "as on the axle point of the chariot wheel are actually existent the undying [Angels or intellectual principles]," which also supplies the answer to the well known problem, "How many Angels can stand on the point of a needle?" More often the nave of the

wheel, rather than the axle point specifically, is treated as its center; nor need this confuse us if we reflect that just as under limiting conditions (indefinite reduction of the radius, or when the central point has been identified but the circle not yet drawn) the center represents the circle, so under similar conditions (metaphysically, in principio) the axle point implies the nave or even the whole wheel the point without dimension, and a principial space not yet expanded (or as the Rg Veda would express it, "closed") being the same in reference. The nave then, kha or nabhi, of the world wheel is regarded as the receptacle and fountain of all order, formative ideas, and goods: for example, 11.28.5, rahydmatō varuna kham rtasya, "may we, O Varuna, win thy nave of Law"; viii.41.6, where in Trita Aptya "all oracles (kavyd) are set as is the nave within the wheel (cakre nabhir iva)"; IV.28, where Indra opens the closed or hidden naves or rocks (apihita . . . khani in verse I, apihitani asna in verse 5) and thus releases the Seven Rivers of Life. In v.32.I, where Indra breaks open the Fountain of Life (utsam), this is again an emptying out of the hollows (khani), whereby the fettered floods are released. The Rivers, of course, represent ensembles of possibility (hence they are often spoken of as "maternal") with respect to a like number of "worlds," or planes of being, as in 1.22.16, prthivya sapta dhamabhih. Our terms kha, asna, etc., are necessarily employed in the plural when the "creation" is envisaged with respect to the cosmos not as a single "world," but as composed of two, three, or seven originally unmanifested but now to be conceptually distinguished "worlds"; the solar chariot having one, two, three, or seven wheels, accordingly. It is perhaps because the chariot of the Year is more often than not thought of as two wheeled (Heaven and Earth, Counterspace and Space), and therefore provided with two analogous axle points, that ani was not later employed as a verbal symbol of "one."

According to an alternative formulation, all things are thought of as ante principium shut up within, and in principio as proceeding from, a common ground, rock, or mountain (budhna, adri, parvata, etc.): this ground, thought of as resting island like within the undifferentiated sea of universal possibility (x.89.4, where the waters pour sagarasya budhnat), is merely another aspect of our axle point (,dni), regarded as the primary assumption toward which the whole potentiality of existence is focused by the primary acts of intellection and will. This means that a priori undimensioned space (kha, akasa, etc.) underlies and is the mother of the point, rather than that the latter has an independent origin; and this accords with the logical order of thought, which proceeds from potentiality to actuality, nonbeing to being. This ground or point is, in fact, the "rock of ages" (asmany anante, 1.130.3; adrim . . . acyutam, v1.i.7.5). Here ante principium Agni lies occulted (guha santam, 1.141.3, etc.) as Ahi Budhnya, "in the ground of space, concealing both his ends" (budhne rajaso . . . guhamdno ants, iv.i.ii, where it may be noted that guhamano anta is tantamount to ananta, literally "end less," "in-finite," "eternal"), hence he is called "chthonic" (nabhir agni prthivya, 1.59.2, etc.), and is born in this ground (jayata prathamah . . . budhne, iv.i.ii) and stands erect, Janus like, at the parting of the ways (ayor ha skambha . . . patham visarge, x.5.6); hence he gets his chthonic steeds and other treasures (asvabudhna, x.8.3; budhnya vasuni, v11.6.7). It is only when this rock is cleft that the hidden trine are freed, the waters flow (1.62.3, where Brhaspati bhinad adrim and vidadgah; v.41.i.2, srnvanty dpah . . . adreh). This is, moreover, a center without place, and hence when the Waters have come forth (that is, when the cosmos has come to be) one asks, as in x.iii.8, "where is their beginning (agram), where their ground (budnah), where now, ye Waters, your innermost center (madhyam . . . antah).

Thus metaphysically, in the symbolism of the Wheel, of counterspace, the surface blank (sunya) in the initial nonbeing (asat) of any formulation (samkalpa) represents the truly infinite (aditi) and maternal possibility of being; the axle point or nave, exemplary being (visvam ekam, RV 111.54.8 = integral omnipresence); the actual construction, a mentally accomplished partition of being into existences; each spoke, the integration of an individual as nama-rupa (psycho physical), that is, as archetypal inwardly and phenomenal outwardly; the felly, the principle of multiplicity (visamatva). Or, employing a more theological terminology: the undetermined surface represents the Godhead (aditi, parabrahman, tamas, apah); the axle point or immovable rock, God (aditya, aparabrahman, isvara, jyoti); the circle of the nave, Heaven (svarga); any point on the circumference of the nave, an intellectual principle (nama, deva); the felly, Earth with its analogous (anurupa) phenomena (visva rupani); the construction of the wheel, the sacrificial act of creation (karma, srsti), its abstraction, the act of dissolution (laya). Furthermore, the course (gati) of any individual upon the pathway of a spoke is in the beginning **centrifugal (pravrtta, bhava, samsarati, paticcasamuppada) and then again centripetal (nivrta, nisbandhu, epistrophe, samadhi, synthesis etc.)**, until the center (madhya) is found; and when the center of individual being coincides with the center of the wheel, he is emancipated (mukta), the extension of the wheel no longer involving him in local motion, at the same time that its entire circuit now becomes for him one picture (jagaccitra) seen in simultaneity, who as "round about seer," paridrastr, now "overlooks everything," visvam . . . abhicaste, 1.164.44.

In order to understand the use of terms for "space" (kha, ukasa, antariksa, sunya, etc.), rather counterspace, as verbal symbols of zero (which represents privation of number, and is yet a matrix of number in the sense $0 = X-X$), it must be realized that akasa, etc., represent primarily a concept not of physical space, but of a purely principial space without dimension, though the matrix of dimension." For example, "all these beings arise out of the space (akasad samapadyanta) and return into the space (akasm pratyastam yanti). For the space is older than they, prior to them, and is their last resort (parayanam)," CU I.9.I; "space is the name of the permissive cause of individual integration (akaso vai nama namarupayor nirvahita)," CU VIII.14; and just as India "opens the closed spaces (apihitj khani)," RV IV.2H.I, so the Self "awakens this rational [cosmos] from chat space (akasad esa khalu idam cetamatram dobhayati)," MU VI.17, in other words, ex nihilo fit. Furthermore, the locus of this "space" is "within you": "what i's the intrinsic aspect of expansion is the supernal fiery energy in the vacance of the inner man (tat svarupam nabhasah khe antarbhutasya yat param tejah)," MU VII.II; and this same "space in the heart" (antarhrdaya akasa) is the locus (dyatana, vesma, nada, kosla, etc.) where are deposited in secret (guha nihitam) all that is ours already or may be ours on any plane (loka) of experience (CU VIII.I.13). At the same time, in BU v.i, this "ancient space" (kha) is identified with the Absolute and with the Spirit (kham brahma, kham puranam, vayuram kham iti), and this Absolute is at the same time a plenum or pleroma (purna) such that "when plenum is taken from plenum, plenum yet remains."

Here we get precisely that equivalence of kha and puma, void and plenum, which was remarked upon as noteworthy in the verbal

notation of the mathematicians. The thought, moreover, is almost literally repeated when Bhaskara in the Bijaganita defines the term ananta thus: ayam ananto rasih khahara ity ucyate. Asmin vikarah khahare na rasavapi pravistesvapi nihsrtesu bahusvapi syal layasrstikale 'nante 'cyute bhutaganesu yadvat, that is, "This fraction of which the denominator is zero, is called an infinite quantity. In this quantity consisting of that which has cipher for its divisor, there is no alteration, though many be added or subtracted; just as there is no alteration in the Infinite Immovable (anante acyute) at the time of the emanation or resolution of worlds, though hosts of beings are emanated or withdrawn." In Rg Veda, X, 85, 12, "the chariot is in the mode of Intellect (anomanasmayam), the Breath of Life (vyana) was the axle (aksa) fastened there." It will be understood that the axle point (ani) that penetrates the hollow (kha) in the nave (na'bhi) is central in each wheel; so in Rg Veda, I, 35, 6, the Undying Angels (se. the Several Angels, visve devah, Adityas) are said to depend upon Savitr (the Supernal Sun as prime mover) "as on the chariot's axle point (ani)," and in Aitareya A.ranyaka, II, 7, the Self is compared to the "twin axle points (ani) "of the Veda. We have thus dwelt at some length on the Vedic implications of the wheel or wheels, because it is important to realize the wider content and consequent power of this symbol, which was so extensively employed in metaphysics, though with a more restricted application.

It may be observed further that while in the Rg Veda we "do not find the use of names of things to denote numbers, we do find instances of numbers denoting things." In vii.103.1, for example, the number "twelve" denotes the "year"; in X.71.3, "seven" stands for "rivers of life" or "states of being." It is thus merely a converse usage of words when the mathematicians make use of the names of things to denote numbers; to take the most obvious examples, it is just what should be expected, when we find that r is expressed by such words as adi, indu, abja, prthvi; 2 by such as yama, asvina; 3 by such as agni, vaisvanara, haranetra, bhuvana; 4 by veda, dis, yuga, samudra, etc.; 5 by prana; 6 by rtu; and so forth. It is not to be understood, of course, that the number words are all of Vedic origin; many suggest rather an Epic vocabulary, e.g., pandava for 5, while others, such as netra for 2, have an obvious and secular source. In certain cases an ambiguity arises, for example, loka as representing either 3 or 14, dis as representing 4 or 10, but this can be readily understood; in the last mentioned case, for example, the quarters have been thought of in one and the same cosmology as either four, or if we count up eight quarters and half quarters, adding the zenith and nadir, as ten. Taken in its entirety as cited by Singly the numeral vocabulary can hardly antedate the beginning of the Christian era (we find that 10 is represented, among other words, by avatara; and 6 by raga).

If we attempt to account for the forms of the ideograms of numbers in a similar fashion, we shall be on much less certain ground. A few suggestions may nevertheless be made. For example, a picture writing of the notion "axle point" could only have been a "point," and of the concept "nave" could only have been a "round O," and both of these signs are employed at the present day to indicate "zero." The upright line that represents "one" may be regarded as a pictogram of the axis that penetrates the naves of the dual wheels, and thus at once unites and separates Heaven and Earth. The Devandgari and Arabic signs for "three" correspond to the trident (trisula), which is known to have been from very ancient times a symbol of Agni or Siva. A priori it might be expected that a sign for "four" should be cruciform, following the notion of extension in the directions of the four airs; and in fact we find in Saka script that "four" is represented by a sign X, and that the Devandgari may well be thought of as a cursive form derived from a like prototype. Even if there be sufficient foundation for such suggestions, it is hardly likely that a detailed interpretation of ideograms of numbers above four could now be deduced. We can only say that the foregoing suggestions as to the nature of numerical ideograms rather support than counter the views of those who seek to derive the origins of symbolism, script, and speech from the concept of the circuit of the year.

It is, however, beyond question that many of the verbal symbols the case of kha for "zero" or counterspace is conspicuous; used by Indian mathematicians had an earlier currency, that is to say before a development of mathematical science as such, in a more universal, metaphysical context. That a scientific terminology should thus have been formulated on the basis of a metaphysical terminology, and by no means without a full consciousness of what was being done (as the citation from Bhaskara clearly shows), is not only in accordance with all that we know of the natural course of Indian thought, which takes the universal for granted and proceeds to the particular, but also admirably illustrates what from a traditionally orthodox point of view would be regarded as constituting a natural and right relationship of any special science to the metaphysical background of all sciences. One is reminded of words in the Encyclical of Pope Leo XIII, dated 1879, on the "Restoration of Christian Philosophy": "Hence, also, the physical sciences, which now are held in so much repute, and everywhere draw to themselves a singular admiration, because of the wonderful discoveries made in them, would not only take no harm from a restoration of the philosophy of the ancients, but would derive great protection from it. For the fruitful exercise and increase of these sciences it is not enough that we consider facts and contemplate Nature. When the facts are well known we must rise higher, and give our thoughts with great care to understanding the nature of corporeal things, as well as to the investigation of the laws which they obey, and of the principles from which spring their order, their unity in variety, and their common likeness in diversity. It is marvelous what power and light and help are given to these investigations by Scholastic philosophy, if it be wisely used...there is no contradiction, truly so called, between the certain and proved conclusions of recent physics, and the philosophical principles of the Schools." These words by no means represent a merely Christian apologetic, but rather enunciate a generally valid procedure, in which the theory of the universal acts at the same time with suggestive force and normatively with respect to more specific applications. We may reflect, on the one hand, that the decimal system, with which the concept "zero" is inseparably connected, was developed by Indian scholars who were very surely, as their own words prove, deeply versed in and dependent upon an older and traditional metaphysical interpretation of the meaning of the world; and on the other, that had it not been for its boasted and long maintained independence of traditional metaphysics (in which the principles, if not the facts, of relativity are explicit), modern scientific thought might have reached much sooner than has actually been the case a scientifically valid formulation and proof of such characteristic notions as those of an expanding universe and the finity of physical space. What has been outlined above with respect to the special science of mathematics represents a principle no less valid in the case of the arts, as could easily be demonstrated at very great length. For example, what is implied by the statement in ABVI.27, that "it is

in imitation of the angelic works of art that any work of art such as a garment or chariot is made here, is actually to be seen in the hieratic arts of every traditional culture, and in the characteristic motifs of the surviving folk arts everywhere. Or in the case of literature: epic (Volsunga Saga, Beowulf, the Cuchullain and Arthurian cycles, Mahdbhdrata, Buddhacarita, etc.) and fairy tale (notably, for example, Jack and the Beanstalk) repeat with infinitely varied local coloring the one story of jatavida, Genesis. The whole point of view can, indeed, be recognized in the Indian classification of traditional literature, in which the treatises (sastras) on auxiliary science such as grammar, astronomy, law, medicine, architecture, etc., are classed as Vedanga, "limbs or powers of the Veda," or as Upaveda", accessory with respect to the Veda".

Experimenters are blooming with thoughts and wonderful new vortex testing based upon this work. Vortex technology is the future, and it is already here and about to explode on the world!

Ever since the second edition of the book has come out there has been a small explosion of new experimentation and investigation by open minded do-it-yourself types. Some are even those with hundreds of videos and significant background and skills in electrical engineering that amazed themselves upon investigation of the magnetic vortex, or hyperboloid. It's untapped potential and the missing dielectric 'secret' behind the entire premise of the "magnet" has countless inventions yet to be discovered. Even myself, I have uncovered a small handful, some with amazing potential, some just intellectually amazing, yet all were expected to by there by myself, and they in fact are there and were there when tested. A new dawn on vortex communication, vortex technology is rounding the corner hard and fast!

Below: More testing from youtube user Tinmanpower, used snapshot with his permission. He has been making some interesting videos at: www.youtube.com/user/TinManPower. His creations working form the premise of this book regarding the magnetic vortex.



Below: From youtube user Tinmanpower, used snapshot with his permission. www.youtube.com/user/TinManPower. His creation of the aquamotor (as he calls it), working form the premise of this book.



Below: Another youtube user showing hydrogen bubbles forming a vortex over the pole of a neodymium while undergoing electrolysis.



Below: All below, vortex technology is rounding the corner faster than you realize and is about to make even the very fastest communication look painfully, even insanely slow and obsolete. None of this could be possible without the missing component of light I have illuminated to you, that light has a Z-axis radial dielectric component.

Twisted laser vortex breakthrough could lead to near-infinite bandwidth, new science

By Sebastian Anthony on September 24, 2013 at 11:16 am

22 Comments

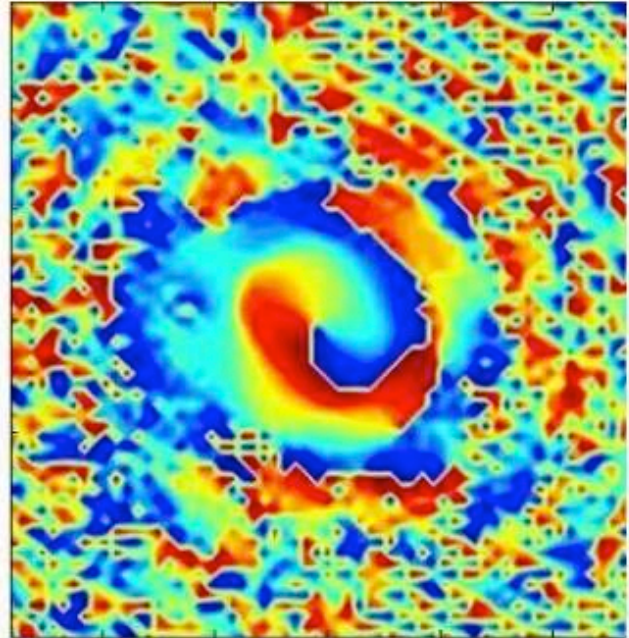
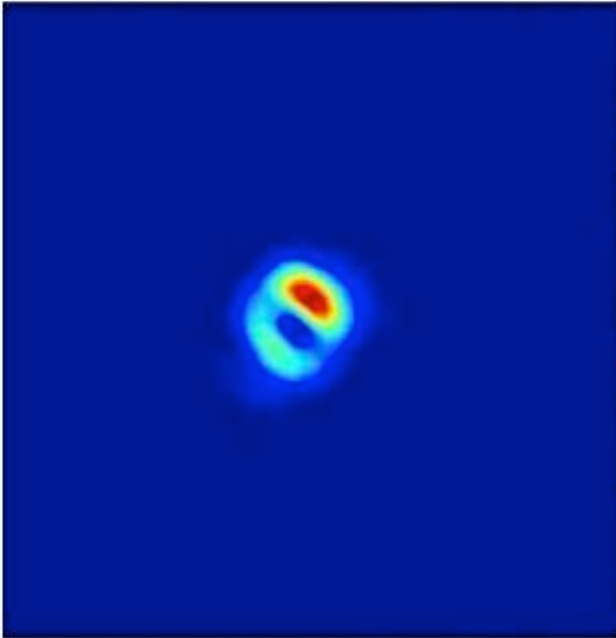

How twisted light transmits data faster than ever

Evan Ackerman Tuesday, June 26, 2012 - 6:44am

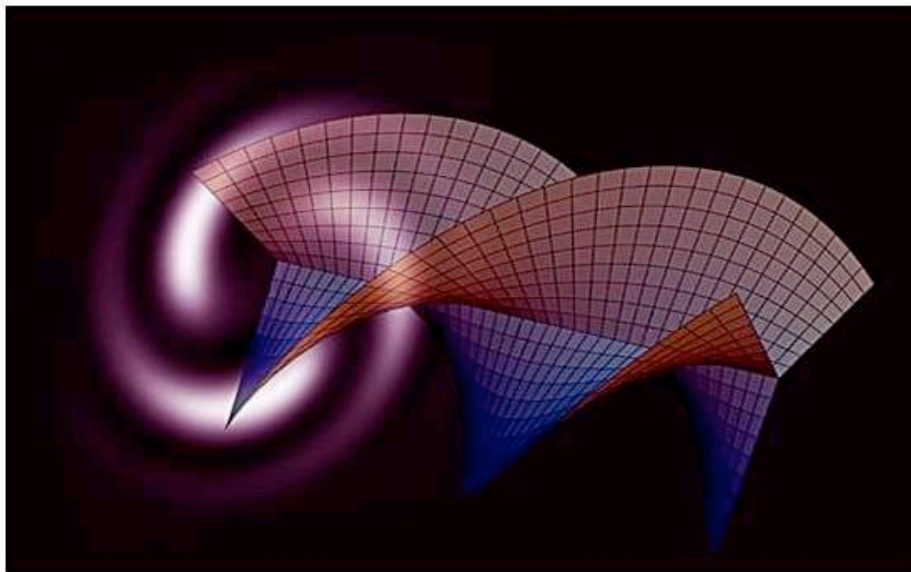

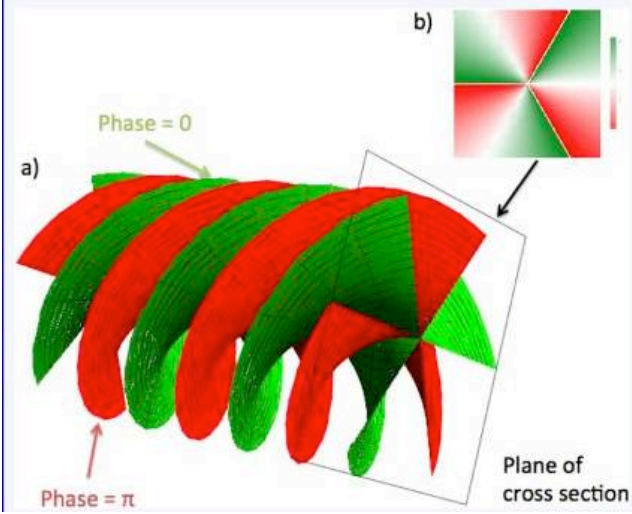
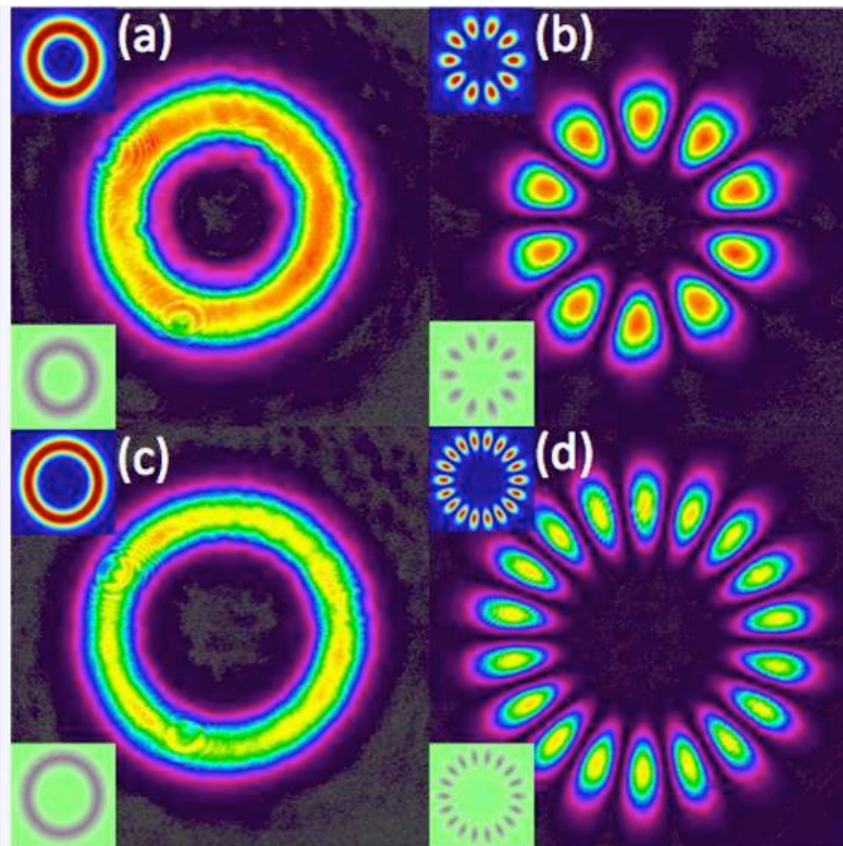

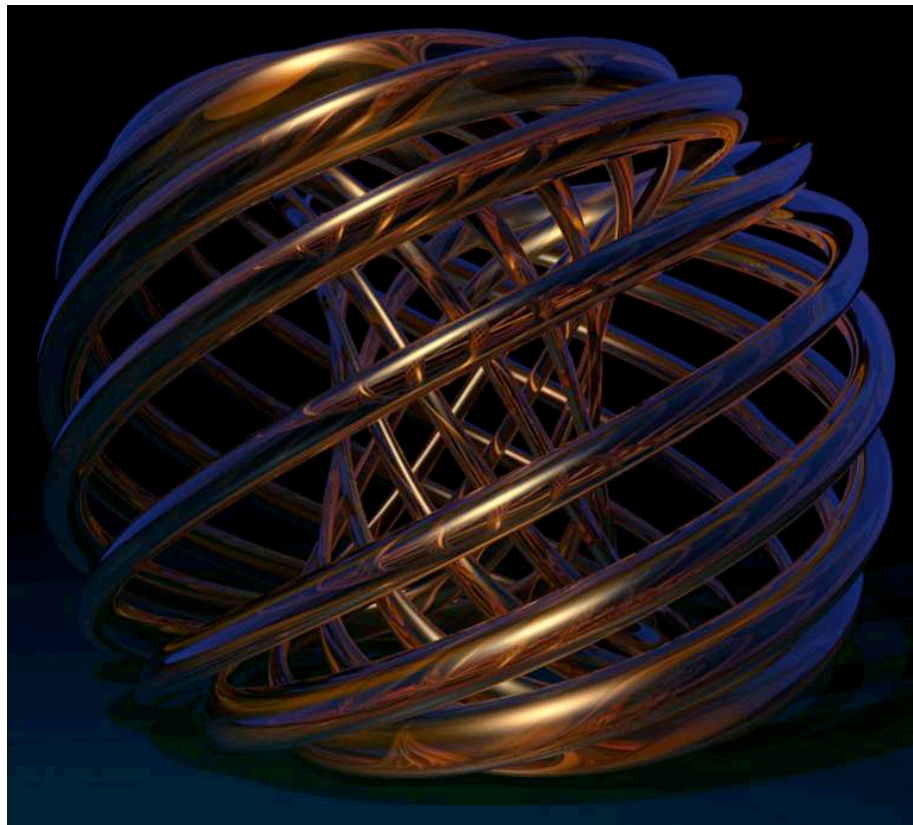
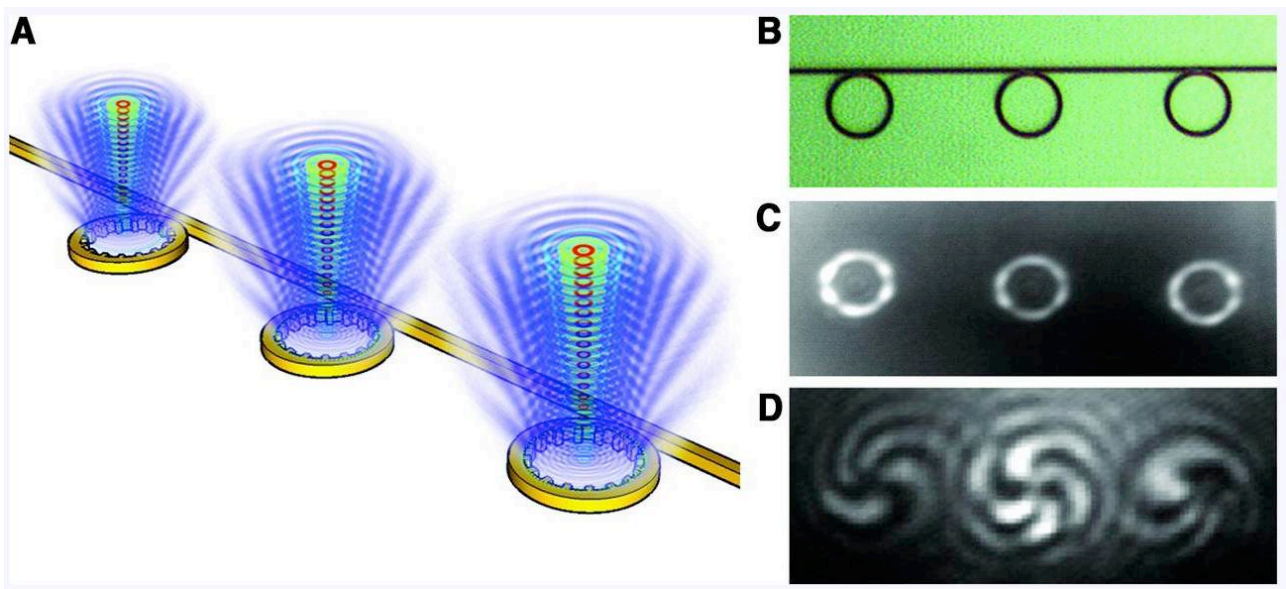

τὰ πάντα ῥεῖ καὶ οὐδὲν μένει
τί τάχιστον; Νοῦς. Διὰ παντὸς γὰρ τρέχει

COPYRIGHT 5-2014 Ken Wheeler

#1 PRESSURE / FLOW

#2 GEOMETRY

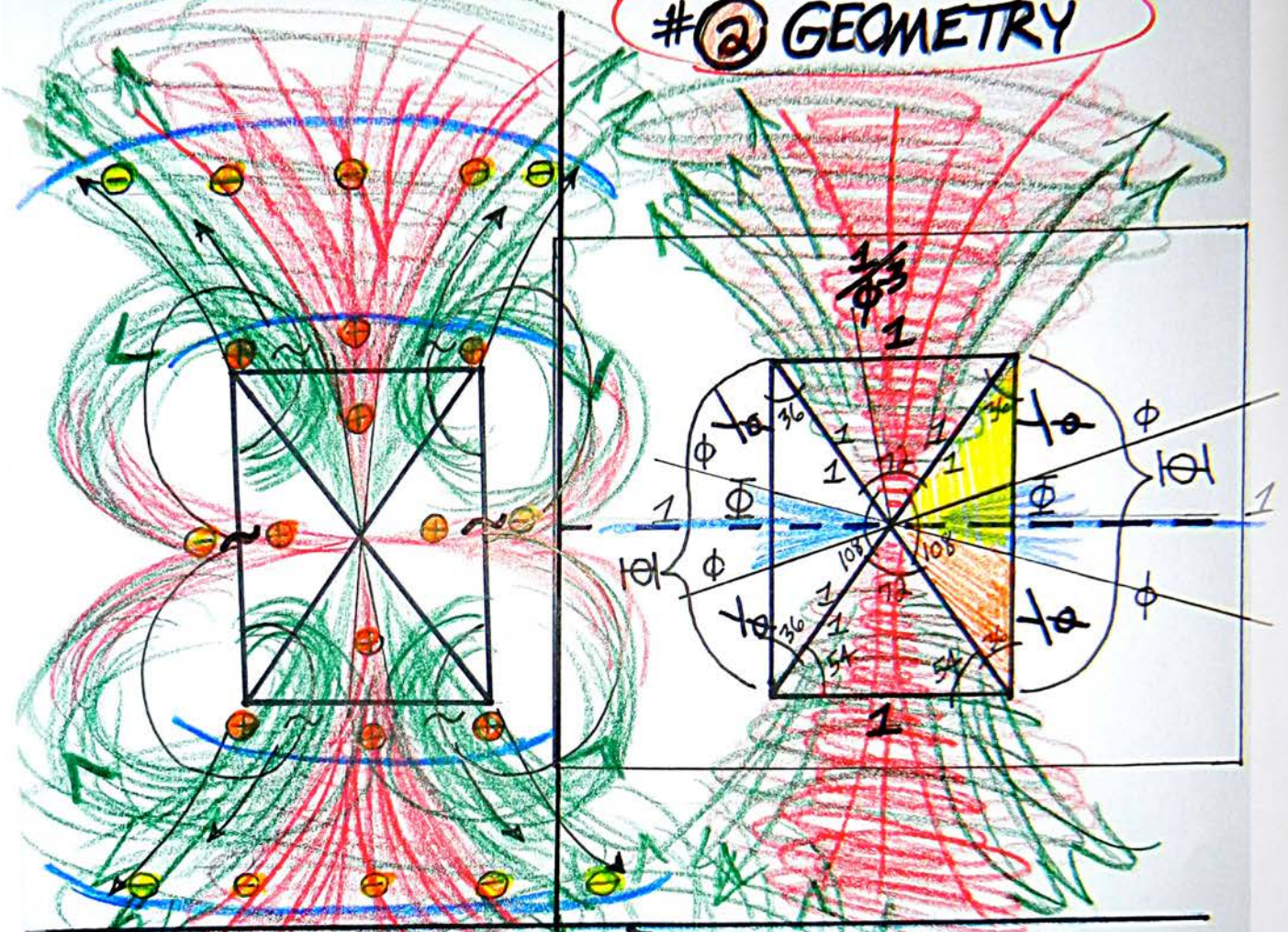

#3 TOP VIEW

- = HIGH PRESSURE
- = LOW PRESSURE
- ~ INTERMEDIATE
- CENTRIPETAL VORTEX
- CENTRIFUGAL VORTEX



© 2014
Ken Wheeler

PLATE 3

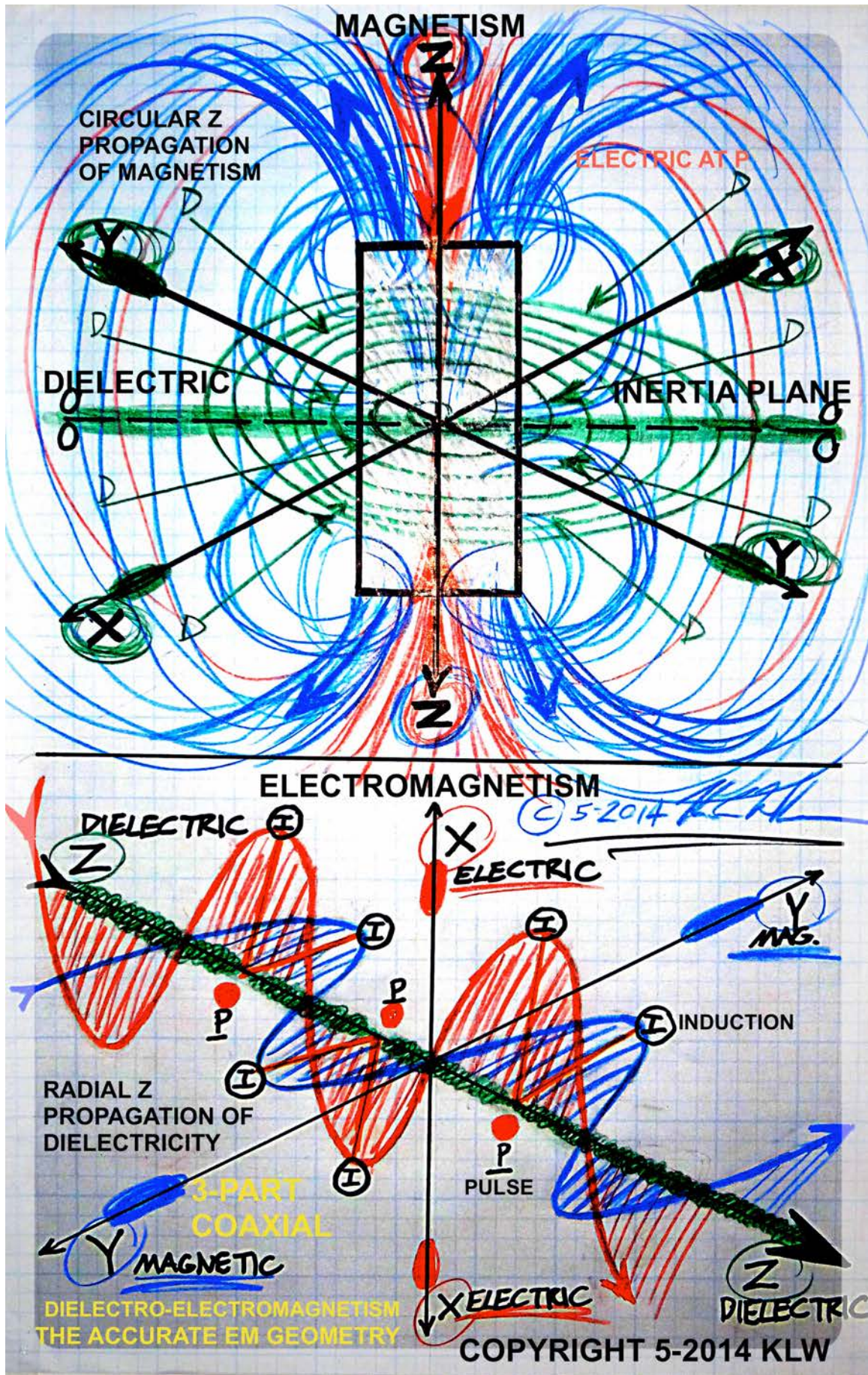

Below: What is this? I will explain this in the 4th edition. Its depth, and importance are both broad and tall. *Discovery and copyright 5-1-2014 Ken L. Wheeler*



4TH EDITION DUE OUT VERY SOON! THERE IS AN ENORMOUS AMOUNT OF MATERIAL TO ADD.

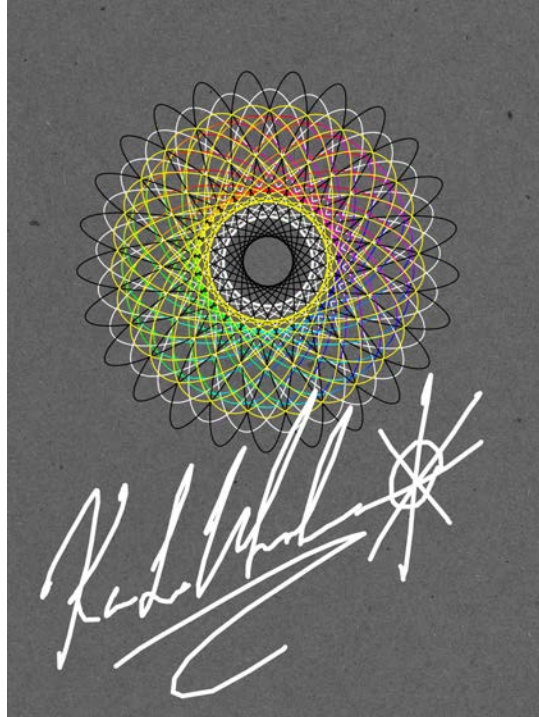

NIKOLA TESLA DEBUNKS EINSTEIN & RELATIVITY

"Today's scientists have substituted mathematics for experiments, and they wander off through equation after equation, and eventually build a structure which has no relation to reality. The scientists of today think deeply instead of clearly. One must be sane to think clearly, but one can think deeply and be quite insane" - N. Tesla

"To say that in the presence of large bodies space becomes curved is equivalent to stating that something can act upon nothing. I, for one, refuse to subscribe to such a view." - N. Tesla

"Relativity is a beggar wrapped in purple whom ignorant people take for a king." The theory, "he said, "wraps all these errors and fallacies and clothes them in magnificent mathematical garb which fascinates, dazzles and makes people blind to the underlying errors. The theory is like a beggar clothed in purple whom ignorant people take for a king. Its

"My conclusions differ from Einstein's and to that extent tend to disprove the Einstein Theory. My explanations of natural phenomena are not so involved as his. They are simpler, and when I am ready to make a full announcement it will be seen that I have proved my conclusions." - N. Tesla

"Too bad, Sir Isaac, they dimmed your renown and turned your great science upside down. Now a long haired crank, Einstein by name, puts on your high teaching all the blame. He says: matter and force are transmutable and wrong the laws you thought immutable. I am much too ignorant, my son, for grasping (crazy) schemes so finely spun." - N. Tesla (Fragments of Olympian Gossip. by Nikola Tesla regarding Einstein)

"The theory of relativity is a mass of error and deceptive ideas violently opposed to the teachings of great men of science of the past and even to common sense." - N. Tesla

"Einstein is a beggar dressed in purple clothes and made king using dazzling mathematics that obscure truth." - N. Tesla

"Since action and reaction are coexistent, it follows that the supposed curvature of space is entirely impossible." - N. Tesla

"The scientists from Franklin to Morse were clear thinkers and did not produce erroneous theories." - N. Tesla

"My followers are of stronger mind...And I am content to stay behind." - N. Tesla

This work is dedicated to those who could see clearly: Nikola Tesla, J.C. Maxwell, C.P. Steinmetz, Oliver Heaviside, and Eric P. Dollard... before the insanity of Einstein and relativity destroyed it all.

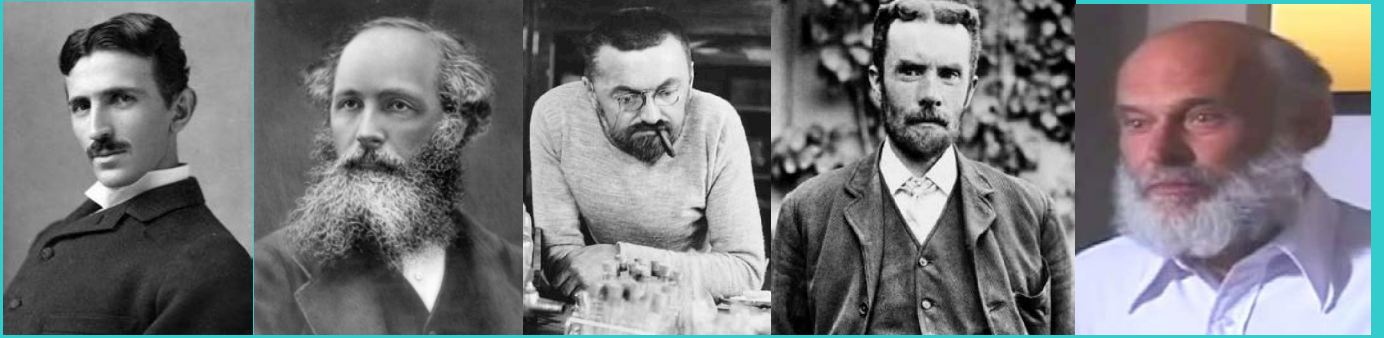

UT LAUDARENT DEOS. SAPIENTIAE LAUS SUMMOM. LAUDABANT SUMMUM INCORRUPTIBILIS. NIHIL EST, QUAM SUMMOM SAPIENTIA



**ΑΓΕΩΜΕΤΡΗΤΟΣ
ΜΗΔΕΙΣ ΕΙΣΙΤΩ**